**HIGH PERFORMANCE TRANSISTOR INVERTER
TRUE TORQUE CONTROL DRIVE SERIES**

TOSHIBA



**TOSVERT-130
TRANSISTOR INVERTER**

MODBUS COMMUNICATIONS INTERFACE MANUAL

Introduction

Thank you for purchasing the “Modbus Communications Interface” for the Toshiba TOSVERT-130 G3 High-Performance Transistor Inverter. Before using the Modbus interface, please be sure to thoroughly read the instructions and precautions contained in this manual. In addition, please make sure that this instruction manual is delivered to the end user of the inverter unit into which the Modbus interface kit is installed, and keep this instruction manual in a safe place for future reference or inverter inspection.

This instruction manual describes the device specifications, wiring methods, maintenance procedures, protocol, functions and usage methods for the Modbus communications interface.

Usage Precautions

Operating Environment

- Please use the interface only when the ambient temperature of the inverter unit into which the interface is installed is within the following specified temperature limits:
Operation: -10 ~ +40°C (+14 ~ +104°F)
Storage: -25 ~ +65°C (-13 ~ +149°F)
- Avoid installation locations that may be subjected to large shocks or vibrations.
- Avoid installation locations that may be subjected to rapid changes in temperature or humidity.

Installation · Wiring

- Do not touch charged parts such as the terminal block while the inverter's CHARGE lamp is lit. A charge will still be present in the inverter unit's internal electrolytic capacitors, and therefore touching these areas may result in an electrical shock. Always turn all inverter input power supplies OFF, and wait at least 5 minutes after the CHARGE lamp has gone out before wiring the communication cables or motor wiring.
- When installing the interface board into the inverter and making wiring connections, make certain that no clippings or wiring leads that could cause device failure fall into the inverter or onto electronic components.
- Proper ground connections are vital for both safety and signal reliability reasons. For proper grounding procedures, please refer to the section in this manual pertaining to grounding (section 2).
- Route the communication cables separate from the inverter input/output power wiring.
- To avoid the possibility of electric shock due to leakage currents, always ground the inverter unit's E/GND terminal and the motor. To avoid misoperation, do not connect the Modbus interface board's SHIELD terminal to either of the above-mentioned grounds or any other power ground.

Other Precautions

- The inverter's EEPROM has a life span of 10,000 write cycles. Do not write to the same holding register (other than register 01 (frequency command), register 02 (input command) or write-only coils) more than 10,000 times.
- Do not touch or insert a rod or any other item into the inverter while power is applied, as this may lead to electrical shock or inverter damage.
- Commission the disposal of the interface board to a specialist.
- Do not assign the same address to more than one inverter in the same network.
- Individual slave addresses can be set from 1 ~ 247. Addresses 0 and 248 ~ 255 are invalid, and will cause the inverter to trip "OPTION PCB ERROR".
- When the inverter's control power supply is turned on, the inverter performs initialization functions for approximately 3 seconds, during which communications capabilities are disabled. Communications capabilities will also be disabled for approximately 3 seconds after momentary control power supply outages or inverter resets.

TABLE OF CONTENTS

1. Interface Board Installation / Removal	5
1.1 Before Installation.....	5
1.2 Installation Procedure	5
1.3 Removal.....	8
1.3.1 Before Removal	8
1.3.2 Removal Procedure	9
2. Grounding	11
3. Equipment Specifications	11
4. Maintenance And Inspection	12
5. Storage And Warranty	13
5.1 Storage.....	13
5.2 Warranty	13
6. Modbus Interface Board Configuration	14
7. G3 Parameter Settings	16
8. Modicon Programming	17
8.1 Supported Modbus Commands.....	17
8.2 Programmable Pointer Register Function.....	17
8.3 Loss of Communications Timer Function	18
8.4 Response Delay Timer Function.....	19
9. Modbus Programming Registers	20
9.1 Write-Only Registers	22
9.2 Read-Only Registers	23
9.3 Read/Write Registers	27
9.3.1 GROUP:FUNDAMENTAL PARAMETERS #1.....	27
9.3.2 GROUP:FUNDAMENTAL PARAMETERS #2.....	28
9.3.3 GROUP:PANEL CONTROL PARAMETERS.....	28
9.3.4 GROUP:TERMINAL SELECTION PARAMETERS.....	29
9.3.5 GROUP:SPECIAL CONTROL PARAMETERS.....	33
9.3.6 GROUP:FREQUENCY SETTING PARAMETERS.....	34
9.3.7 GROUP:PROTECTION FUNCTION PARAMETERS.....	37
9.3.8 GROUP:PATTERN RUN CONTROL PARAMETERS.....	39
9.3.9 GROUP:FEEDBACK CONTROL PARAMETERS.....	42
9.3.10 GROUP:COMMUNICATION SETTING PARAMETERS.....	43
9.3.11 GROUP:AM/FM TERMINAL ADJUSTMENT PARAMS.....	44

TOSHIBA

9.3.12 GROUP:UTILITY PARAMETERS	45
9.3.13 GROUP:MOTOR RATING PARAMETERS.....	47
9.3.14 Programmable Pointer Registers.....	47
9.4 Write-Only Coils	48
9.5 Read-Only Coils	49
9.6 Inverter Fault Codes	50
10. Notes.....	52

1. Interface Board Installation / Removal

The Modbus Communications Option ROM enclosed with the Modbus kit is compatible only with G3 inverters with V120 or later main software. An error will occur if the option ROM is installed in an inverter with pre-V120 main software. The main software version number is printed on the CPU package (IC1) on the control board. Additionally, this version number can be read from inverter memory by displaying the parameter CPU VERSION in GROUP:UTILITY PARAMETERS. If you are unsure of the software version of your inverter, please contact Toshiba International Corporation for more information.

The Modbus option ROM version number is printed on the label attached to the ROM. The option ROM version number can also be read from the inverter's memory and displayed on the LCD panel after initialization by displaying the parameter ROM VERSION in GROUP:UTILITY PARAMETERS. The option ROM version number replaces the standard ROM version number after installation/initialization.



IMPORTANT NOTE: The option ROM included with the Modbus interface kit is for installation into G3 230V/460V units only. Do not install the option ROM into any other inverter unit (such as H3, E3, or G3 600V units). All inverter units other than the G3 230V/460V series are shipped from the factory with full communications capability, and installation of the option ROM may cause incorrect operation or inverter damage.

1.1 Before Installation

All parameters will be automatically reset to the factory default values after the option ROM is installed in the inverter. If it is desired to retain the current parameter settings, the user should access the user-changed parameter group to display and record all the parameters and setting values that have been changed from factory defaults. Even if the current settings are saved to non-volatile memory by setting the STANDARD SETTING MODE SELECTION parameter in GROUP:UTILITY PARAMETERS to 5*, they will be erased from memory during initialization of the option ROM.

- *Setting the standard mode selection parameter will be referred to in this manual as performing a **TYPE X RESET**, where X is the parameter setting value.*





1.2 Installation Procedure

Installation of the TOSHIBA Modbus option ROM and interface board into a TOSVERT-130 G3 inverter should only be performed by a qualified technician familiar with the maintenance and operation of the G3. To install the option ROM and interface board, complete the following steps:

1. Record the option ROM version number located on the label of the option ROM in the following box. The option ROM version is the number immediately following the "V" on the ROM label. For example, if the label indicates "V6401", the option

ROM version is 6401. This version number will be used later in the installation process. Option ROM version = .

Record the standard ROM version number prior to option ROM installation. The standard ROM version can be read from parameter ROM VERSION in GROUP:UTILITY PARAMETERS.
Standard ROM version = .

2.  **CAUTION!** Verify that all input power sources to the inverter have been turned OFF and are locked and tagged out.
3.  **DANGER!**  Wait at least 5 minutes for the inverter's electrolytic capacitors to discharge before proceeding to step 4. **Do not touch any internal parts with power applied to the inverter, or for at least 5 minutes after power to the inverter has been removed. A hazard exists temporarily for electrical shock even if the source power has been removed.**
4.  Remove the inverter's cover (open the door on units with hinged doors). Verify that the CHARGE LED has gone out before continuing the installation process.
5. Loosen the 4 screws attaching the G3's operation panel support bracket to the control board support bracket, and then remove the operation panel and support bracket as a unit (refer to Figure 1).

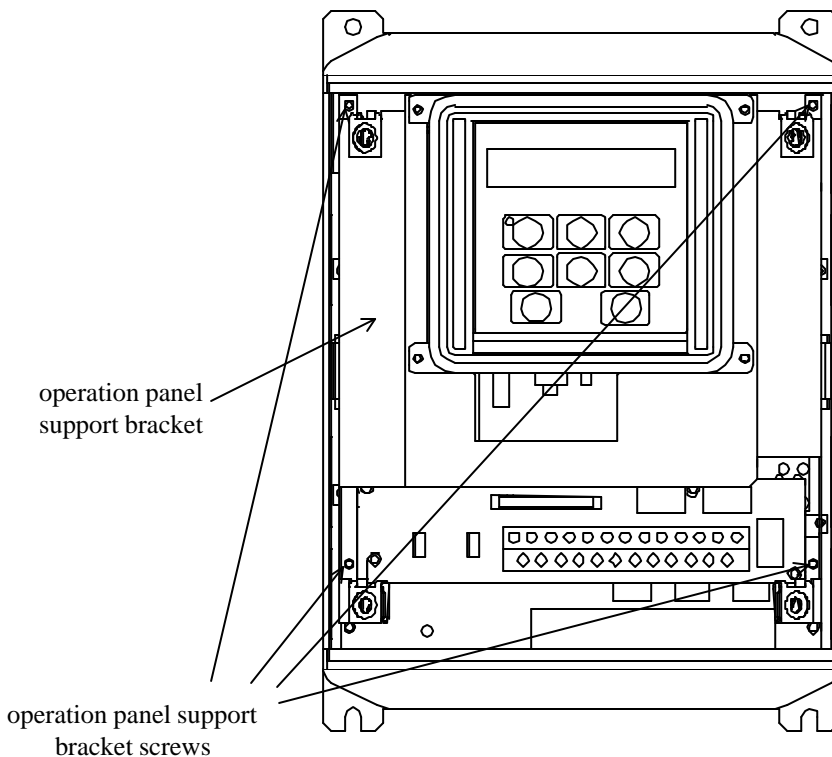



Figure 1: G3 with front cover removed

6.  **CAUTION!** The option ROM PCB assembly and interface board are static-sensitive devices. Standard electrostatic-sensitive component handling precautions should be observed. Locate the option ROM connector, labeled CN41, on the lower-left side of the control PCB. Line up the connector on the back of the option ROM PCB with CN41. Install the option ROM by pressing gently but firmly on the option ROM PCB until a slight “click” is felt. Verify that the option ROM PCB is seated properly and firmly in CN41. If the option ROM connector does not appear to be mating with CN41 properly, verify that the ROM is oriented properly and that there are no obstructions in either connector.
7. Set the Modbus interface board's DIP switches for the desired communication parameters (refer to section 6).
8. Install the 4 nylon standoffs into the holes provided in the control board support bracket (refer to Figure 2).

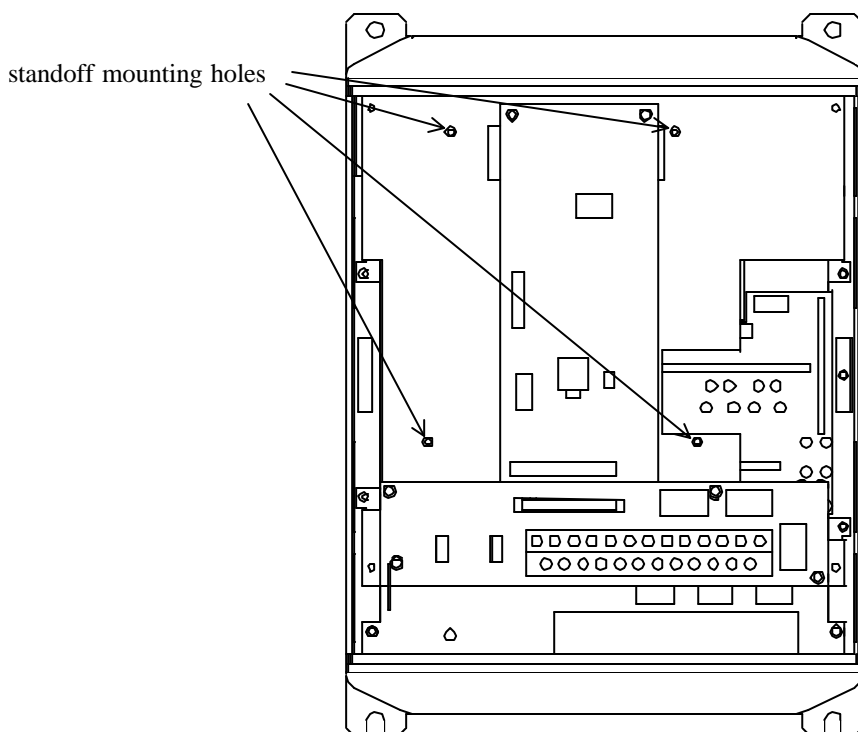



Figure 2: *G3 with front cover and operation panel support bracket removed*

9. Install the Modbus network cable through the access holes at the bottom of the inverter and route the cable in order to make connections to the interface board connector (TB1). Take care to not route the cable near any sharp edges or in positions where it may be pinched.
10. Connect the Modbus cable to the interface board connector (TB1).

 **CAUTION!** Extremely high voltages exist in the area near the Modbus interface board and connector (TB1). Ensure that no stray wires (such as the shield on the Modbus communications wire) come into contact with any internal

inverter components. Also ensure that the communications cable is not routed in such a manner that it may come into contact with high-voltage inverter components, or inverter components that may heat up during operation and damage the cable insulation.

11. Install the interface board into the inverter by carefully aligning the 4 nylon standoffs with the 4 mounting holes provided in the interface board. Ensure that connector CN5A on the back side of the interface board is aligned with connector CN5 on the front side of the control board.
12. Press the interface board firmly onto the standoffs and connector CN5 until the standoff retaining tabs lock. Ensure that CN5 and CN5A are thoroughly interlocked.
13. Carefully re-install the operation panel and support bracket and tighten the 4 screws that attach the operation panel support bracket to the control board support bracket.
14. Reinstall the inverter's cover (close and latch door on units with hinged doors).



DANGER!



Do not operate the unit with the cover off / cabinet door open.

15. Turn all power sources to the inverter unit ON, and verify that the inverter functions properly. If the inverter unit does not appear to power up, or does not function properly, immediately turn power OFF. **Repeat steps 2 ~ 4 to remove all power from the inverter.** Then, verify all connections. Contact Toshiba International Corporation for assistance if the problem persists.
16. To perform final verification that the option ROM is installed properly, display the value of the ROM VERSION parameter in GROUP:UTILITY PARAMETERS. This number should match the option ROM version number that was recorded in step 1. If this parameter value does not match the option ROM version number recorded in step 1, **repeat steps 2 ~ 4 to remove all power from the inverter**, then re-verify that the option ROM is installed properly. If the option ROM appears to be installed properly, but the version numbers still do not match, contact Toshiba International Corporation for further assistance.

1.3 Removal

Removal of the Modbus interface board from a TOSVERT-130 G3 inverter should only be performed by a qualified technician familiar with the maintenance and operation of the G3. In order to protect the interface board connector's reliability, do not repeatedly connect and disconnect the interface. Use the following procedure if it becomes necessary to remove the Modbus interface board from the inverter.



CAUTION!





Do not remove the interface board while power is applied to the inverter. Removing the interface board with power applied may damage the inverter.

1.3.1 Before Removal

The inverter will display an error message if the option ROM becomes dislodged or is removed from its socket. The inverter must be reset to clear this error. Therefore, all

parameters will be automatically reset to the factory default values after an option ROM has been removed from the inverter. If it is desired to retain the current parameter settings, the user should access the user-changed parameter group to display and record all the parameters and setting values that have been changed from factory defaults. Even if the current settings are saved using the TYPE 5 RESET function, they will be erased from memory during the re-initialization of the inverter after the option ROM has been removed.

1.3.2 Removal Procedure

1.  **CAUTION!** Verify that all input power sources to the inverter have been turned OFF and are locked and tagged out.
2.  **DANGER!**  Wait at least 5 minutes for the inverter's electrolytic capacitors to discharge before proceeding to step 3. **Do not touch any internal parts with power applied to the inverter, or for at least 5 minutes after power to the inverter has been removed. A hazard exists temporarily for electrical shock even if the source power has been removed.**
3.  Remove the inverter's cover (open the door on units with hinged doors). Verify that the CHARGE LED has gone out before continuing the removal process.
4. Loosen the 4 screws attaching the operation panel support bracket to the control board support bracket and remove the operation panel and support bracket as a unit (refer to Figure 3).

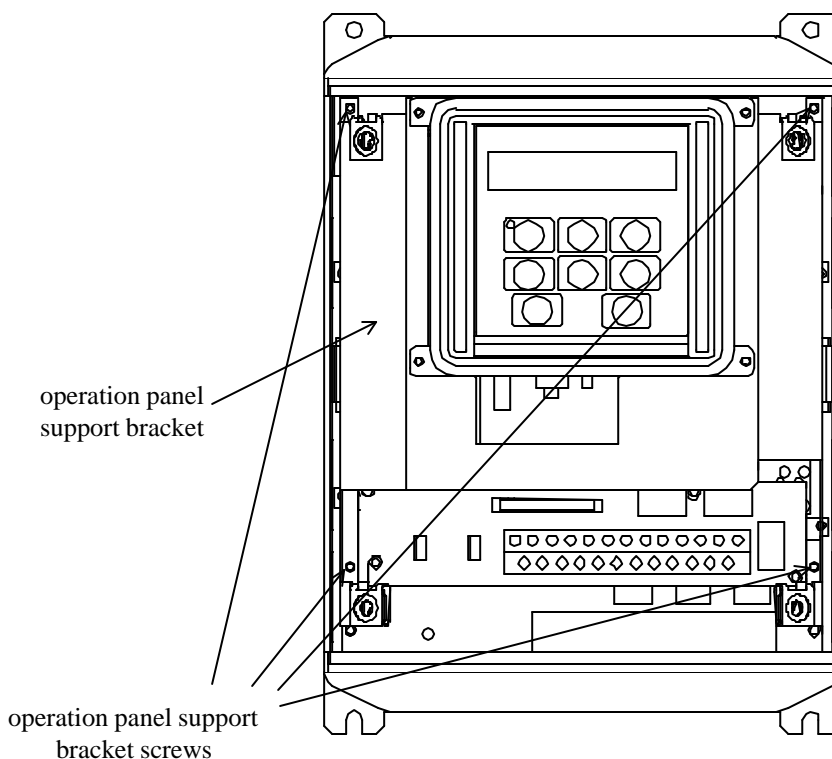



Figure 3: G3 with front cover removed

5.  **CAUTION!** The option ROM PCB and Modbus interface board are static-sensitive devices. Standard electrostatic-sensitive component handling precautions should be observed. Release the 4 corners of the interface board from the standoffs by pressing down on the standoff locking tabs with a small flat-headed screwdriver. Be careful to not apply any abnormal stress to the interface board while performing this, as this may damage the interface board or control board connectors.
6. Remove the interface board from the inverter.
7. Disconnect the communications cable from the interface board connector (TB1), and pull the cable out through the access holes at the bottom of the inverter.
8. Locate the option ROM in the option ROM connector, labeled CN41, on the lower-left side of the control PCB. Gently work the option ROM PCB up and down while pulling on it until the ROM releases from the control PCB option ROM connector.



IMPORTANT NOTE: Do not remove the option ROM on inverter units that were received from the factory with option ROMs pre-installed. Units that are shipped from the factory with option ROMs pre-installed (H3 and 600V G3 units, for example) require these ROMs for correct operation, and removal of the option ROM may cause incorrect operation or inverter damage. If you are in doubt about the requirement of an option ROM in your inverter unit, contact Toshiba International Corporation for assistance.

9. Carefully re-install the operation panel and support bracket and tighten the 4 screws that attach the operation panel support bracket to the control board support bracket.
10. Reinstall the inverter's cover (close and latch the door on units with hinged doors).



DANGER!



Do not operate unit with the cover off / cabinet door open.

11. Turn all power sources to the inverter unit ON, and verify that the inverter functions properly. If the inverter unit does not appear to power up, or does not function properly, immediately turn power OFF. **Repeat steps 1 ~ 3 to remove all power from the inverter.** Then, verify all connections. Contact Toshiba International Corporation for assistance if the problem persists.
12. To re-initialize the inverter after the ROM has been removed, perform a TYPE 3 reset. After the initialization sequence, display the value of the ROM VERSION parameter in GROUP:UTILITY PARAMETERS. This number should match the standard ROM version number that was recorded prior to option ROM installation. If this parameter value does not match the value recorded earlier, contact Toshiba International Corporation for further assistance.

2. Grounding

Grounding is of particular importance for reliable, stable operation. Communication system characteristics may vary from system to system, depending on the system environment and grounding method used. A ground connection with an impedance of less than 100Ω should be used. Please be sure to consider the following points for making proper ground connections:

Grounding method checkpoints

1. Make all ground connections such that no ground current flows through the inverter case.
2. Ensure that all grounds are connected to points that are at the same potential as inverter grounds.
3. Do not connect the Modbus interface board's SHIELD terminal to a power ground or any other potential noise-producing ground connection (such as the inverter's E/GND terminal).
4. Do not make connections to unstable grounds (paint-coated screw heads, grounds that are subjected to inductive noise, etc.)
5. Use copper wire with a cross-sectional area of 2mm² or larger, or aluminum wire with a cross-sectional area of 2.6mm² or larger for grounding.

3. Equipment Specifications

Item	Specification
Operating Environment	Indoors, less than 1000m above sea level, do not expose to direct sunlight or corrosive / explosive gasses.
Operating Temperature	-10 ~ +40°C (+14 ~ +104°F)
Storage Temperature	-25°C ~ +65°C (-13 ~ +149°F)
Relative Humidity	20% ~ 90% (without condensation)
Vibration	5.9m/s ² {0.6G} or less (10 ~ 55Hz)
Grounding	Use a ground connection with an impedance of less than 100Ω.
Cooling Method	Self-cooled

4. Maintenance And Inspection

Preventive maintenance and inspection is required to maintain the Modbus communication interface in its optimal condition, and to ensure a long operational lifetime. Depending on usage and operating conditions, perform a periodic inspection once every three to six months. Before starting inspections, always turn off all power supplies to the inverter unit, and wait at least five minutes after the inverter's "CHARGE" lamp has gone out.



DANGER!



Do not touch any internal parts with power applied to the inverter, or for at least 5 minutes after power to the inverter has been removed. A hazard exists temporarily for electrical shock even if the source power has been removed.

Inspection Points

- Check that the wiring terminal screws are not loose. Tighten if necessary.
- Check that there are no defects in any wire terminal crimp points. Visually check that the crimp points are not scarred by overheating.
- Visually check the wiring and cables for damage.
- Clean off any accumulated dust and dirt. Place special emphasis on cleaning the ventilation ports of the inverter and all installed PCBs. Always keep these areas clean, as adherence of dust and dirt can cause premature component failure.
- If use of the inverter unit is discontinued for extended periods of time, turn the power on at least once every two years and confirm that the unit still functions properly.
- Do not perform hi-pot tests on the inverter or Modbus interface board, as they may damage the unit's internal components.

Please pay close attention to all periodic inspection points and maintain a good operating environment.

5. Storage And Warranty

5.1 Storage

Observe the following points when the Modbus interface board is not used immediately after purchase or when it is not used for an extended period of time.

- Avoid storing the interface board in places that are hot or humid, or that contain large quantities of dust or metallic dust. Store the interface board in a well-ventilated location.
- When not using the Modbus interface board for an extended period of time, turn the power on at least once every two years and confirm that it still functions properly.

5.2 Warranty

The Modbus communications interface kit is covered under warranty for a period of 12 months from the date of installation, but not to exceed 18 months from the date of shipment from the factory. For further warranty or service information, please contact Toshiba International Corporation.

6. Modbus Interface Board Configuration

The Modbus interface board uses an 8-position DIP switch (labeled SW1) to configure the network communication characteristics. The switch settings are only read during initialization, so if a change is made to any of the switches on SW1, the inverter must be reset in order to enable the new settings. The various configuration settings of SW1 are as follows:

Communication Method:

SW1 # 1	Function
OFF	Modbus RTU
ON	Modbus ASCII

Baud Rate:

SW1 #			Function
4	3	2	
OFF	OFF	OFF	300 baud
OFF	OFF	ON	600 baud
OFF	ON	OFF	1200 baud
OFF	ON	ON	2400 baud
ON	OFF	OFF	4800 baud
ON	OFF	ON	9600 baud
ON	ON	OFF	19.2 kbaud
ON	ON	ON	38.4 kbaud

Parity:

SW1 #		Function
6	5	
OFF	OFF	even parity
OFF	ON	odd parity
ON	OFF	no parity (2 stop bits)
ON	ON	no parity (1 stop bit) - <i>applies only to RTU mode</i>

Protocol:

SW1 # 8	Function
OFF	Modicon Modbus
ON	<i>DO NOT SELECT</i> (reserved for future expansion)

SW1 #7 is not used and its setting is therefore irrelevant.

Additionally, a jumper on the interface board (labeled JP1) sets whether or not the Modbus network is terminated at the interface board (termination is 121Ω resistor). Only the 2 devices at the extreme ends of the Modbus network should have JP1 set to "TERM". All other devices should have JP1 set to "OPEN".

A Note About Modbus Communication Formats

According to the *Modicon Modbus Protocol Reference Guide*, the specifications for both Modbus ASCII and RTU communication modes are as follows:

ASCII Mode

Coding System:.....Hexadecimal, ASCII characters 0 ~ 9, A ~ F
One hexadecimal character contained in each ASCII character of the message

Bits per Byte:.....1 start bit
7 data bits, least significant bit sent first
1 bit for even/odd parity; no bit for no parity
1 stop bit if parity is used; 2 bits if no parity

Error Check Field:...Longitudinal Redundancy Check (LRC)

RTU Mode

Coding System:.....8-bit binary, hexadecimal 0 ~ 9, A ~ F
Two hexadecimal characters contained in each 8-bit field of the message

Bits per Byte:.....1 start bit
8 data bits, least significant bit sent first
1 bit for even/odd parity; no bit for no parity
1 stop bit if parity is used; 2 bits if no parity

Error Check Field:...Cyclical Redundancy Check (CRC)

According to the Modicon Modbus specification, therefore, the number of bits per byte in ASCII mode is 1 start + 7 data + 1 parity + 1 stop (if parity is used), or 1 start + 7 data + 2 stop (if parity is not used). The ASCII data frame is therefore fixed at 10 bits per byte. Similarly, the number of bits per byte in RTU mode is 1 start + 8 data + 1 parity + 1 stop (if parity is used), or 1 start + 8 data + 2 stop (if parity is not used), resulting in an RTU data frame that is fixed at 11 bits per byte.

In addition to these standard specified data frame sizes, the G3 Modbus interface board offers an optional configuration of providing for only 1 stop bit when no parity is selected in the RTU communication mode. As indicated on the previous page, by setting SW5 and SW6 both to "ON", the RTU data frame size is modified to consist of 1 start + 8 data + 1 stop bit = 10 bits per byte. Please note that this setting is only valid when RTU mode is selected; if SW5 and SW6 are both set to "ON" when ASCII mode is selected, the inverter will trip "OPTION PCB ERROR" upon initialization.

7. G3 Parameter Settings

Modbus interface board communications are enabled by setting parameter `COMMUNICATION SELECTION` in `GROUP:COMMUNICATION SETTING PARAMETERS` to 2 (Modbus, Tosline-F10, DeviceNet). No other Tosline-F10 communication parameter settings apply when using the Modbus interface. Similar to when using any communication interface card, the option frequency command and command input can be enabled by setting parameters `FREQUENCY MODE SELECTION` and `COMMAND MODE SELECTION`, respectively, in `GROUP:UTILITY PARAMETERS` to 3. For more information on methods for changing parameter settings, refer to the TOSHIBA [G3 Operation Manual](#).

The following is a list of the parameter settings that are required during setup to enable Modbus communications:

Parameter	Group	Required Value
BLIND FUNCTION SELECTION	GROUP:UTILITY PARAMETERS	1
COMMUNICATIONS PARMS BLIND	GROUP:UTILITY PARAMETERS	1
COMMUNICATION SELECTION	GROUP:COMMUNICATION SETTING PARAMETERS	2
INVERTER ID NUMBER	GROUP:COMMUNICATION SETTING PARAMETERS	any value other than 0 or 248~255.

As is the same with all other communication configuration parameters, the inverter must be reset after making the parameter changes described above in order for the changed settings to be enabled.

IMPORTANT: *The standard factory setting for parameter `INVERTER ID NUMBER` is 0, which is reserved by the Modbus controller as the address used for broadcast transmissions. If this parameter is not changed prior to enabling Modbus communications, the inverter will trip "OPTION PCB ERROR". Similarly, if an inverter number of 248 ~ 255 is set, the inverter will trip "OPTION PCB ERROR".*

If the G3 inverter into which a Modbus communications interface board is installed trips "OPTION PCB ERROR" for any reason during initialization or operation, it is incapable of being reset via the Modbus network. When this trip condition occurs, therefore, the inverter can only be reset locally via the panel or control terminal block.

If inverter control (frequency command input, RUN/STOP, etc.) is to be performed via the Modbus network, the following inverter parameters must also be set as shown:

Parameter	Group	Required Value
COMMAND MODE SELECTION	GROUP:UTILITY PARAMETERS	3
FREQUENCY MODE SELECTION	GROUP:UTILITY PARAMETERS	3

8. Modicon Programming

8.1 Supported Modbus Commands

The G3 Modbus interface board supports 5 Modbus commands: command 1 (0x01: read coil status), command 3 (0x03: read holding registers), command 5 (0x05: force single coil), command 6 (0x06: preset single register) and command 16 (0x10: preset multiple registers). Not all registers or coils support all commands (for example, read-only registers cannot be written to with a command 16). For more information, refer to section 9. The following limits represent the maximum number of registers and coils that can be read/written in one packet transaction:

Command	RTU Mode Read Max	RTU Mode Write Max	ASCII Mode Read Max	ASCII Mode Write Max
1	16 coils	N/A	16 coils	N/A
3	125 registers	N/A	61 registers	N/A
5	N/A	1 coil only	N/A	1 coil only
6	N/A	1 register only	N/A	1 register only
16	N/A	123 registers	N/A	59 registers

8.2 Programmable Pointer Register Function

Registers 24B ~ 28A are used as programmable pointer and data registers. The first 32 of these registers (24B ~ 26A) are used to define other register addresses from which you would like to read or write, and the remaining 32 registers (26B ~ 28A) are the actual registers used to access the data located at the register addresses defined in registers 24B ~ 26A. For example, if you would like to continuously read the data from registers 05, 06, 1E, and 190, the standard register configuration would require 3 read commands to be issued: one reading 2 registers starting at register 05, one reading 1 register starting at register 1E, and one reading 1 register starting at register 190. To conserve network bandwidth and speed processing time, however, the programmable pointer registers can be used to allow the same information to be accessed, but by only issuing 1 command which reads 4 registers.

To configure this function, program as many registers as necessary (up to 32) in the range 24B ~ 26A with the register numbers of the registers you would like to continuously access. In this example, we would set register 24B to 05 (the first register number we want to access), register 24C to 06, register 24D to 1E, and register 24E to 190. The data located at these registers can then be obtained by accessing the corresponding registers in the range 26B ~ 28A (data register 26B corresponds to address register 24B, data register 26C corresponds to address register 24C, etc.) Therefore, the 4 registers that are to be monitored can now be accessed simply by issuing 1 read command with a length of 4 starting from register 26B. The returned data will be the data obtained from registers 05, 06, 1E, and 190 (in that order).

Note that the settings of the programmable address registers (24B ~ 26A) are stored in nonvolatile EEPROM. Therefore, do not write to any of these registers more than 10,000 times. Typically, these registers would only be written to once, when the inverter and Modbus network are first commissioned. Also note that when the Modbus interface board is first installed, the default contents of these registers are initialized to 0 ("unconfigured address"). Attempts to read from or write to programmable data registers (26B ~ 28A) which have corresponding programmable address registers set to "unconfigured address" will generate ILLEGAL DATA ADDRESS exceptions (Modbus exception code 02).

8.3 Loss of Communications Timer Function

A configurable "loss of communications" timer function is provided, which can detect communication losses and perform certain actions if a valid packet is not received and processed within a set time period.

Register 1D0 sets the loss of communication time value (adjustable from 100ms to 60.000s in 1ms increments, factory setting = 1.000s). If a valid (exception-free) reception-response (or exception-free broadcast) does not take place within this time limit, the timer will expire. If the timer expires, 5 possible actions can occur, as set by the value of register 1D1 (loss of communications action):

Register 1D1 Setting	Action Taken Upon Timeout
0 (default)	No action: ignore timeout
1	Flash "COMM" on LCD display only
2	Flash "COMM" on LCD display, stop inverter with decelerated stop
3	Trip "OPTION PCB ERROR" (inverter must be reset locally)
4	Flash "COMM" on LCD display, set option frequency command to UPPER LIMIT FREQUENCY (CAUTION!)

Setting 0 is the default setting; when a communications timeout occurs, no action will be taken.

For setting 1 (flash "COMM" on LCD display only), this condition will continue until the next exception-free network packet is received and responded to (if the packet is a broadcast, no response will be sent). The warning condition will then be removed and the timer value reset.

For setting 2 (flash "COMM" on LCD display, stop inverter with decelerated stop), the "COMM" warning will act as described in setting 1, but the inverter stop condition will not be reset when an exception-free network packet is once again received. Note that although the inverter stop condition is set, this only causes the inverter to actually stop if parameter COMMAND MODE SELECTION in GROUP:UTILITY PARAMETERS is set to 3 (communication option input valid). The inverter will then remain stopped until commanded otherwise by the Modbus master.

Setting 3 does not depend on the COMMAND MODE SELECTION or FREQUENCY MODE SELECTION parameters. Note that the "OPTION PCB ERROR" trip can only be cleared locally at the inverter.

Setting 4 will cause the Modbus interface card to automatically modify the option frequency command (register 01) upon a timeout occurrence such that the inverter will accelerate to and continuously run at the UPPER LIMIT FREQUENCY, as set in GROUP:FUNDAMENTAL PARAMETERS #1. Similar to the stop command issued by the Modbus interface card with setting 2 (see above), the value of register 01 will not automatically return to its pre-timeout value once proper network communications are re-established. The Modbus master must specifically modify the value of register 01 once communications are re-established to cause the inverter to run at the desired frequency once again. Note that in order for this setting to actually affect the inverter's operating frequency, parameter FREQUENCY MODE SELECTION in GROUP:UTILITY PARAMETERS must be set to 3 (communication option input valid). Also note that the inverter will accelerate to the UPPER LIMIT FREQUENCY only if the inverter was running at the time of communications loss; otherwise the inverter will remain stopped even though the option frequency command value has been modified. **USE EXTREME CAUTION WHEN SELECTING THIS SETTING!** Thoroughly verify that there is no possibility of personal injury or equipment damage due to the inverter running at the UPPER LIMIT FREQUENCY setting, especially with the possibility that network communications may not be able to be re-established in a timely fashion (depending on what network condition caused the communications timeout in the first place).

Note that the loss of communications timeout time and timeout action are both non-volatile (stored in EEPROM). Therefore, do not write to these registers more than 10,000 times. The timeout time and timeout action are read only upon inverter initialization; therefore, the inverter must be reset after these values have been modified in order for them to take effect.

8.4 Response Delay Timer Function

Register 1D2 contains the setting for a response delay timer function. This function is useful for applications where it may not be desirable for the Modbus interface to respond immediately to the network, such as when a radio modem that must be switched from receive mode to transmit mode is being used.

The response delay timer is adjustable in 1ms increments from 0s to 2.000s (factory setting = 0s). A response delay of 0s means that there is no delay; response packets will be sent by the Modbus interface as soon as they are available. The delay timer starts when a complete packet is received by the Modbus card - a response will not be sent until the timer has expired (at a minimum). Note that this time value only sets a minimum response delay value - depending on the quantity and location of registers read/written, much more time may actually be required before a complete response is formulated and ready to be returned to the network (an approximate value of 60ms per register accessed can be used for most circumstances). For example, if 10 registers are always read/written, the interface board will require approximately 600ms to read/write the registers and formulate a response, so response delay times less than approximately 600ms will have no actual effect.

Like the communications timeout parameters, the response delay timer value is read only upon inverter initialization. This setting is also non-volatile (written to EEPROM). Therefore, do not write to this register more than 10,000 times.

9. Modbus Programming Registers

How To Use This Section:

This section contains tables which describe all of the registers and coils accessible from the Modbus network. The descriptions for the columns in the listed tables are as follows:

Register / Coil...The register number / coil number used to access the parameter.

BitThis column only applies to write-only registers (section 9.1) and read-only registers (section 9.2). If the register is comprised of a collection of individual bit-oriented command/status items (for example, register 02), this column will indicate which bit(s) in the word-sized register the corresponding parameter described in the *Function* column uses (bit 0 = LSB, bit F = MSB). If the parameter uses the whole register, "word" will appear in this column, indicating the parameter consumes the entire register (this does not mean, however, that all register bits are used: refer to the explanation for *Mask* below). All read/write registers (section 9.3) have word-size data. Other possible values in this column are "low byte" (bits 0 ~ 7) and "high byte" (bits 8 ~ F).

Function.....Describes the function accessed through this holding register.

Bank0 = RAM (volatile), 1 = EEPROM (nonvolatile), 0/1 = RAM & EEPROM, DPRAM = interface board dual-port RAM (volatile), 2 & 3 = code space (read-only). **IMPORTANT:** the inverter's EEPROM has a life span of 10,000 write cycles. Do not write to a read/write holding register whose bank is listed as 1 or 0/1 more than 10,000 times.

MaskThe data bits within a register that are not covered by the hexadecimal mask (for example, bits 8 ~ F if the mask is 00FF) will always be returned as 0 during data reads and will be ignored during data writes. For example, if a hexadecimal value of AB98 is sent to a register whose mask is 00FF, the actual value written to the register's corresponding parameter will be 0098. As this is not considered an error, no exception response will be generated if this type of extraneous data condition occurs.

Adjustment Range ... Indicates valid data settings in real terms (Hz, ON/OFF, etc.)

MultiplierIndicates scaling factor used to convert *Adjustment Range* data into integer values. The equation used for this conversion is:

$$\text{Actual Holding Register Data} = \text{Real Data} \div \text{Multiplier}$$

For example, if 60.00Hz frequency command were desired, register 01 must be set to $[60.00 \div 0.01] = 6000$ decimal (= 1770 hex).

Example Table Excerpt:

Register	Bit	Function	Bank	Mask	Adjustment Range	Multiplier
01	word	Frequency command	DPRAM	FFFF	0.00 ~ 400.00Hz Actual frequency will be limited by LL, UL and Fmax.	0.01
02	0	RUN command	DPRAM	—	0: Stop 1: Run	—
	1	STOP Command (has priority over RUN command)			0: run enabled 1: stop	
	2	Forward • reverse run selection			0: reverse 1: forward	

Other Programming Register Notes:

- Throughout this document, the abbreviations "LL", "UL", and "Fmax" will stand for LOWER LIMIT FREQUENCY, UPPER LIMIT FREQUENCY, and MAXIMUM OUTPUT FREQUENCY, respectively.
- Reading from registers, register areas or coils marked as "Reserved" will return data values of 0. Writing to registers, register areas or coils marked as "Reserved" will have no effect. In both of these cases, as these actions are not considered errors, no exception response will be generated.
- Certain holding registers cannot be written to while the inverter is running. These registers will be indicated by the character (*). If an attempt is made to write to these registers while the inverter is running, an exception response will be generated.
- The holding register data for all read/write registers with *Bank* information listed as 0/1 will be retrieved from bank 0 (RAM) during reads and will be written to both banks 0 and 1 (RAM and EEPROM) during writes.
- All parameters in GROUP: COMMUNICATION SETTING PARAMETERS (section 9.3.10) are retrieved from non-volatile memory upon inverter initialization. When any of these registers are modified, therefore, the inverter must be reset for the changed values to take effect.

9.1 Write-Only Registers

Register	Bit	Function	Bank	Mask	Adjustment Range	Multiplier
01	word	Frequency command	DPRAM	FFFF	0.00 ~ 400.00Hz Actual frequency will be limited by LL, UL and Fmax.	0.01
02	0	RUN command	DPRAM	—	0: Stop 1: Run	—
	1	STOP Command (has priority over RUN command)			0: run enabled 1: stop	
	2	Forward • reverse run selection			0: reverse 1: forward	
	3	Acc/dec #1 / #2 selection			0: Acc / dec #1 1: Acc / dec #2	
	4	Reserved			—	
	5	Reserved			—	
	6	Reserved			—	
	7	Jog mode selection			0: Normal (acc/dec mode) 1: Jog mode	
	8	Feedback control			0: Feedback valid 1: Feedback invalid	
	9	Compulsory DC injection braking mode			0: No compulsory DC injection braking 1: Compulsory DC injection below DC INJECTION START FREQUENCY	
	A	Fundamental parameter switching			0: V/F #1 1: V/F #2	
	B	Gate block command (coast stop command)			0: Normal 1: Gate block	
	C	Emergency off command			0: Does nothing 1: Emergency off	
D	Reset command (trip clear)	0: Does nothing 1: Reset				
E	Reserved	—				
F	Reserved	—				
03	word	Reserved	DPRAM	—	—	—
04	word	Reserved	DPRAM	—	—	—

9.2 Read-Only Registers

Register	Bit	Function	Bank	Mask	Adjustment Range	Multiplier
05	word	Output frequency monitor	DPRAM	FFFF	0.00 ~ 400.00Hz	0.01
06	0	Run • stop status	DPRAM	—	0: Stopped 1: Running	—
	1	Run enable			0: Run enabled 1: Stopped	
	2	Forward • reverse status			0: Reverse 1: Forward	
	3	Acc / dec #1 / #2 selection status			0: Acc / dec #1 1: Acc / dec #2	
	4	Reserved			—	
	5	Fault status			0: Faulted 1: Not Faulted	
	6	Reserved			—	
	7	Jog mode status			0: Normal (acc/dec mode) 1: Jog mode	
	8	Feedback enable status			0: Feedback invalid 1: Feedback valid	
	9	Compulsory DC injection braking mode			0: DC inject. braking inactive 1: DC inject. braking active	
	A	Fundamental parameter switching			0: V/F #1 1: V/F #2	
	B	Coast stop command status			0: Normal 1: Coast to stop	
	C	Emergency off command			0: Normal 1: Emergency off	
	D	Reserved			—	
E	Main Circuit Undervoltage	0: Normal 1: Undervoltage				
F	Reserved	—				
07	word	Output current monitor	DPRAM	00FF	0 ~ 255%	1
08	word	Output voltage monitor (Note 1)	DPRAM	FFFF	0 ~ 232%	0.1
09	word	IV terminal analog input value	0	FFFF	0000 ~ FFFF (0% ~ 100%)	1
0A	word	RX terminal analog input value	0	FFFF	0000 ~ 7FFF (-100% ~ 0%) 7FFF ~ FFFF (0% ~ 100%)	1
0B	word	Frequency command monitor	0	FFFF	0000 ~ 9C40 (0.00 ~ 400.00 Hz)	0.01
0C	word	Input voltage monitor (Note 1)	0	FFFF	0 ~ 255%	0.1
0D	word	Input terminal status monitor	0	FFFF	Refer to Table 1 (page 25)	—
0E	low byte	Output terminal status monitor	0	00FF	Refer to Table 2 (page 25)	—
	high byte	Inverter Status 2		FF00		
0F	word	Inverter Status 1	0	FFFF	Refer to Table 3 (page 26)	—
10	word	Present trip	0	00FF	Refer to section 9.6 for fault codes	—
11	high byte	4th Past trip (most recent)	0	7F00		—
	low byte	3rd past trip		007F		
12	high byte	2nd past trip	0	7F00		—
	low byte	1st past trip (oldest)		007F		
13	word	Pre-compensation output frequency	0	FFFF	0000 ~ 9C40 (0.00 ~ 400.00 Hz)	0.01

Register	Bit	Function	Bank	Mask	Adjustment Range	Multiplier
14	word	Post-compensation output frequency	0	FFFF	0000 ~ 9C40 (0.00 ~ 400.00 Hz)	0.01
15	word	Torque current monitor	0	FFFF	(Note 2)	0.01
16	low byte	Excitation current monitor	0	00FF	00 ~ FF (0 ~ 255%)	1
	high byte	Reserved	—	—	—	—
17	word	PID feedback value	0	FFFF	(Note 2)	0.02
18	word	Motor overload ratio	0	FFFF	0 ~ 65535	100/65535
19	word	Inverter overload ratio	0	FFFF	0 ~ 65535	100/65535
1A	word	DBR overload ratio	0	FFFF	0 ~ 65535	100/65535
1B	word	Input power (%)	0	FFFF	0 ~ 6553.5	0.1
1C	word	Input power (kW)	0	FFFF	(Note 3)	
1D	word	Output power (%)	0	FFFF	(Note 2)	0.1
1E	word	Output power (kW)	0	FFFF	(Note 2, Note 3)	
1F	word	RR input	0	FFFF	0 ~ 65535	100/65535
20	word	CPU version number	2	FFFF	—	—
21	word	External ROM version number	3	FFFF	—	—
22	word	EEPROM version number	1	FFFF	—	—
23	low byte	Inverter typeform monitor	0	00FF	Refer to Table 4 (page 26)	—
	8	Input / output power units	0	0100	0: 0.01kW 1: 0.1kW	—
	9,A	Command mode status	0	0600	00: terminal 01: panel 10: option 11: RS232C	—
	B,C	Frequency mode selection status	0	1800	00: terminal 01: panel 10: option 11: RS232C	—
	D,E, F	Reserved	—	—	—	—
24	low byte	Modbus Interface card software revision	—	—	—	—
	high byte	Modbus Interface card software version	—	—	—	—
25	word	Output current (amps)	—	FFFF	0.0 ~ 6553.5 A	0.1

(Note 1) These monitor voltage units are not affected by the setting of `VOLTAGE_UNITS_SELECTION` in `GROUP:UTILITY_PARAMETERS`; they are always in units of %.

(Note 2) These registers use signed data (data values larger than 7FFFH are negative). If the register data is 8000H or larger, the actual value can be obtained by: **actual value = - [FFFFH - (register data) + 1]**.

(Note 3) If the input / output power units data is 0, the monitored data is in 0.01kW units, and the multiplier is 0.01. If the input / output power units data is 1, the monitored data is in 0.1kW units, and the multiplier is 0.1. These values are automatically set according to the inverter's capacity.

Table 1: Input Terminal Status Monitor (register 0D)

Lower Byte	Bit	Input Terminal	0	1	Single-Bit Read Mask
	bit 0	F	terminal - CC open	terminal - CC shorted	0001
	bit 1	R	terminal - CC open	terminal - CC shorted	0002
	bit 2	S1	terminal - CC open	terminal - CC shorted	0004
	bit 3	S2	terminal - CC open	terminal - CC shorted	0008
	bit 4	S3	terminal - CC open	terminal - CC shorted	0010
	bit 5	S4	terminal - CC open	terminal - CC shorted	0020
	bit 6	S5 (option)	terminal - CC open	terminal - CC shorted	0040
	bit 7	S6 (option)	terminal - CC open	terminal - CC shorted	0080

Upper Byte	Bit	Input Terminal	0	1	Single-Bit Read Mask
	bit 0	unused (always 0)	—	—	—
	bit 1	unused (always 0)	—	—	—
	bit 2	unused (always 0)	—	—	—
	bit 3	unused (always 0)	—	—	—
	bit 4	unused (always 0)	—	—	—
	bit 5	S7 (option)	terminal - CC open	terminal - CC shorted	0020
	bit 6	RES	terminal - CC open	terminal - CC shorted	0040
	bit 7	ST	terminal - CC open	terminal - CC shorted	0080

Table 2: Output Terminal Status Monitor / Inverter Status 2 (register 0E)

Lower Byte	Bit	Output Terminal	0	1	Single-Bit Read Mask
	bit 0	unused (always 0)	—	—	—
	bit 1	unused (always 0)	—	—	—
	bit 2	FAN	OFF	ON	0004
	bit 3	FL	FLB-FLC shorted	FLA-FLC shorted	0008
	bit 4	MS relay	OFF	ON	0010
	bit 5	OUT (option)	OUTB-OUTC shorted	OUTA-OUTC shorted	0020
	bit 6	RCH	RCHA-RCHC open	RCHA-RCHC shorted	0040
	bit 7	LOW	LOWA-LOWC open	LOWA-LOWC shorted	0080

Upper Byte	Bit	Inverter Status	0	1	Single-Bit Read Mask
	bit 0	accelerating	not accelerating	accelerating	0001
	bit 1	decelerating	not decelerating	decelerating	0002
	bit 2	for inverter use	—	—	—
	bit 3	retry	not retrying	retrying	0008
	bit 4	running (including DC injection braking)	stopped	running	0010
	bit 5	for inverter use	—	—	—
	bit 6	for inverter use	—	—	—
	bit 7	tripped	not tripped	tripped	0080

Table 3: Inverter Status 1 (register 0F)

Lower Byte	Bit	Inverter Status	0	1	Single-Bit Read Mask
	bit 0	running (acc/dec)	—	running	0001
	bit 1	unused (always 0)	—	—	—
	bit 2	forward / reverse	reverse	forward	0004
	bit 3	acc/dec #1/#2	acc/dec #1	acc/dec #2	0008
	bit 4	for inverter use	—	—	—
	bit 5	for inverter use	—	—	—
	bit 6	for inverter use	—	—	—
	bit 7	jog/normal mode	normal (acc/dec)	jog mode	0080

Upper Byte	Bit	Inverter Status	0	1	Single-Bit Read Mask
	bit 0	feedback ON/OFF	OFF	feedback active	0001
	bit 1	DC inj. braking	OFF	DC inj. braking active	0002
	bit 2	V/F #1/#2	V/F #1	V/F #2	0004
	bit 3	coasting	not coasting	coasting	0008
	bit 4	emergency off	not in emergency off	in emergency off	0010
	bit 5	for inverter use	—	—	—
	bit 6	for inverter use	—	—	—
	bit 7	for inverter use	—	—	—

Table 4: Inverter Typeform Codes

230v Class		460v Class		575v Class	
Inverter Model	Typeform Data (Hex)	Inverter Model	Typeform Data (Hex)	Inverter Model	Typeform Data (Hex)
G3-2010	xx21	G3-4015	xx42	G3-6060	xx65
G3-2015	xx22	G3-4025	xx43	G3-6120	xx67
G3-2025	xx23	G3-4035	xx44	G3-6160	xx68
G3-2035	xx24	G3-4055	xx45	G3-6220	xx69
G3-2055	xx25	G3-4080	xx46	G3-6270	xx6A
G3-2080	xx26	G3-4110	xx47	G3-6330	xx6B
G3-2110	xx27	G3-4160	xx48	G3-6400	xx6C
G3-2160	xx28	G3-4220	xx49	G3-6500	xx6D
G3-2220	xx29	G3-4270	xx4A	G3-6600	xx6E
G3-2270	xx2A	G3-4330	xx4B	G3-6750	xx6F
G3-2330	xx2B	G3-4400	xx4C	G3-610K	xx70
G3-2400	xx2C	G3-4500	xx4D	G3-612K	xx71
		G3-4600	xx4E	G3-615K	xx72
		G3-4750	xx4F	G3-620K	xx73
		G3-410K	xx50		
		G3-412K	xx51		
		G3-415K	xx52		
		G3-420K	xx53		
		G3-425K	xx54		
		G3-430K	xx55		

9.3 Read/Write Registers

9.3.1 GROUP:FUNDAMENTAL PARAMETERS #1

Register	Function / Title		Bank	Mask	Adjustment Range	Multiplier
26	MAXIMUM OUTPUT FREQUENCY (*)		0 / 1	FFFF	0BB8 ~ 9C40 (30.00~400.00)	0.01
27	BASE FREQUENCY #1		0 / 1	FFFF	09C4 ~ 9C40 (25.00~400.00)	0.01
28	BASE FREQUENCY VOLTAGE SELECT (*)		0 / 1	0030	0000: Input voltage level (0) 0020: Automatic setting (1) 0030: Stationary setting (2)	—
29	MAXIMUM OUTPUT VOLTAGE #1		0 / 1	FFFF	0000 ~ 0258 (0 ~ 600)	1
2A	REVERSE OPERATION DISABLE SELECT		0 / 1	0020	0000: Reverse allowed (0) 0020: Reverse not allowed (1)	—
2B	UPPER LIMIT FREQUENCY		0 / 1	FFFF	0000 ~ Fmax	0.01
2C	LOWER LIMIT FREQUENCY		0 / 1	FFFF	0000 ~ UL, Fmax	0.01
2D	VOLTS PER HERTZ PATTERN (*)		0 / 1	000F	0000: Constant torque (1) 0001: Variable torque (2) 0002: Auto. torque boost (3) 0006: #3 w/ auto. energy savings (4) 000A: Vector control (5) 000E: #5 w/ auto. energy savings (6)	—
2E	1, 2	VOLTAGE BOOST #1	0 / 1	FFFF	0000 ~ 012C (0.0 ~ 30.0)	0.1
2F	ACCELERATION TIME #1		0 / 1	FFFF	0001 ~ EA60 (0.01~ 600.00) 0001 ~ EA60 (0.1~ 6000.0)	0.01 0.1
30	DECELERATION TIME #1		0 / 1	FFFF	0001 ~ EA60 (0.01~ 600.00) 0001 ~ EA60 (0.1~ 6000.0)	0.01 0.1
31	ACC/DEC PATTERN #1 SELECTION		0 / 1	0030	0000: Linear (0) 0010: Self-adjusting (1) 0020: S-Pattern #1 (2) 0030: S-Pattern #2 (3)	—
32	ACCEL/DECEL PATTERN ADJUST LOW		0 / 1	00FF	0003 ~ 00FD (0 ~ 50) (Note 1)	1
33	ACCEL/DECEL PATTERN ADJUST HIGH		0 / 1	00FF	0003 ~ 00FD (0 ~ 50) (Note 1)	1

Note 1: Register data = (desired setting x 5 + 3), converted to hexadecimal

9.3.2 GROUP:FUNDAMENTAL PARAMETERS #2

Register	Function / Title	Bank	Mask	Adjustment Range	Multiplier
34	BASE FREQUENCY #2	0 / 1	FFFF	09C4 ~ 9C40 (25.00 ~ 400.00)	0.01
35	MAXIMUM OUTPUT VOLTAGE #2	0 / 1	FFFF	0000 ~ 0258 (0 ~ 600)	1
36	VOLTAGE BOOST #2	0 / 1	FFFF	0000 ~ 012C (0.0 ~ 30.0)	0.1
37	ELECTRONIC THERMAL PROTECT LVL #2	0 / 1	00FF	000A ~ 0064 (10 ~ 100)	1
38	STALL PROTECTION SELECTION #2	0 / 1	0040	0000: ON (0) 0040: OFF (1)	—
39	0 STALL PROTECTION LEVEL #2	0 / 1	00FF	000A ~ 00D7 (10 ~ 215)	1
3A	ACCELERATION TIME #2	0 / 1	FFFF	0001 ~ EA60 (0.1~ 6000.0) 0001 ~ EA60 (0.01~ 600.00)	0.1 0.01
3B	DECELERATION TIME #2	0 / 1	FFFF	0001 ~ EA60 (0.1~ 6000.0) 0001 ~ EA60 (0.01~ 600.00)	0.1 0.01
3C	ACC/DEC PATTERN #2 SELECTION	0 / 1	0030	0000: Linear (0) 0010: Self-adjusting (1) 0020: S-Pattern #1 (2) 0030: S-Pattern #2 (3)	—
3D	ACC/DEC #1/#2 SWITCH FREQUENCY	0 / 1	FFFF	0000 ~ Fmax	0.01

9.3.3 GROUP:PANEL CONTROL PARAMETERS

Register	Function / Title	Bank	Mask	Adjustment Range	Multiplier
3E	DIRECTION SELECTION (FORWARD/REV)	0 / 1	0004	0000: Reverse (0) 0004: Forward (1)	—
3F	STOP PATTERN SELECTION	0 / 1	0040	0000: Decelerated stop (0) 0040: Coast stop (1)	—
40	FUNDAMENTAL PARAM SWITCHING	0 / 1	0004	0000: V/F #1 (1) 0004: V/F #2 (2)	—
41	ACCEL/DECEL #1/#2 SELECTION	0 / 1	0008	0000: Acc / dec #1 (1) 0008: Acc / dec #2 (2)	—
42	PANEL RESET SELECTION	0 / 1	0030	0000: All possible (0) 0010: OL only (1) 0020: OL, OC only (2)	—
43	PANEL FEEDBACK CONTROL	0 / 1	0001	0000: Feedback valid (0) 0001: Feedback invalid (1)	—

9.3.4 GROUP: TERMINAL SELECTION PARAMETERS

Register	Function / Title	Bank	Mask	Adjustment Range	Multiplier
44	INPUT TERMINAL SELECTION	0 / 1	0001	0000: Standard functions (0) 0001: Individual selections (1)	—
45	1 "R" INPUT TERMINAL FUNCTION	0 / 1	FFFF	0000 ~ FFFF (0 ~ 54) Refer to Table 5 (page 31)	—
46	"S1" INPUT TERMINAL FUNCTION				
47	"S2" INPUT TERMINAL FUNCTION				
48	"S3" INPUT TERMINAL FUNCTION				
49	"S4" INPUT TERMINAL FUNCTION				
4A	"F" INPUT TERMINAL FUNCTION				
4B	"RES" INPUT TERMINAL FUNCTION				
4C	"ST" INPUT TERMINAL FUNCTION				
4D	"S5" INPUT TERMINAL FUNCTION				
4E	"S6" INPUT TERMINAL FUNCTION				
4F	"S7" INPUT TERMINAL FUNCTION				
50	POTENTIAL TERMINAL FUNCTION				
51	R, S1-S7 TERMINAL RESPONSE TIME				
52	F INPUT TERMINAL RESPONSE TIME	0 / 1	00FF	0001 ~ 0064 (1 ~ 100)	1
53	RES INPUT TERMINAL RESPONSE TIME	0 / 1	00FF	0001 ~ 0064 (1 ~ 100)	1
54	ST INPUT TERMINAL RESPONSE TIME	0 / 1	00FF	0001 ~ 0064 (1 ~ 100)	1
55	"RCH" CONTACTS FUNCTION	0 / 1	FFFF	0 ~ FFFF (0 ~ 63) Refer to Table 6 (page 32)	—
56	"RCH" CONTACTS DELAY TIME	0 / 1	00FF	0001 ~ 0064 (1 ~ 100)	1
57	"RCH" CONTACTS HOLD TIME	0 / 1	00FF	0001 ~ 0064 (1 ~ 100)	1
58	"LOW" CONTACTS FUNCTION	0 / 1	FFFF	0 ~ FFFF (0 ~ 63) Refer to Table 6 (page 32)	—
59	"LOW" CONTACTS DELAY TIME	0 / 1	00FF	0001 ~ 0064 (1 ~ 100)	1
5A	"LOW" CONTACTS HOLD TIME	0 / 1	00FF	0001 ~ 0064 (1 ~ 100)	1
5B	"FL" CONTACTS FUNCTION	0 / 1	FFFF	0 ~ FFFF (0 ~ 63) Refer to Table 6 (page 32)	—
5C	"FL" CONTACTS DELAY TIME	0 / 1	00FF	0001 ~ 0064 (1 ~ 100)	1
5D	"FL" CONTACTS HOLD TIME	0 / 1	00FF	0001 ~ 0064 (1 ~ 100)	1
5E	"OUT" CONTACTS FUNCTION	0 / 1	FFFF	0 ~ FFFF (0 ~ 63) Refer to Table 6 (page 32)	—
5F	"OUT" CONTACTS DELAY TIME	0 / 1	00FF	0001 ~ 0064 (1 ~ 100)	1

Register	Function / Title		Bank	Mask	Adjustment Range	Multiplier
60	"OUT" CONTACTS HOLD TIME		0 / 1	00FF	0001 ~ 0064 (1 ~ 100)	1
61	LOW SPEED SIGNAL OUTPUT FREQ		0 / 1	FFFF	0 ~ Fmax	0.01
62	ACC/DEC COMPLETE DETECT BAND		0 / 1	FFFF	0 ~ Fmax	0.01
63	SPEED REACH MAXIMUM FREQUENCY		0 / 1	FFFF	0 ~ Fmax	0.01
64	SPEED REACH MINIMUM FREQUENCY		0 / 1	FFFF	0 ~ Fmax	0.01
65	COMMERCIAL POWER/INV SWITCHING OUTPUT		0 / 1	00C0	0000: OFF (0) 0040: Auto switch on trip (1) 0080: At COMMERCIAL PWR/INV SWITCH FREQ (2) 00C0: Both (1) and (2) (3)	—
66	2, 3	COMMERCIAL POWER/INV SWITCH FREQ	0 / 1	FFFF	0 ~ Fmax	0.01
67	"FP" OUTPUT TERMINAL PULSE FREQUENCY		0 / 1	0003	0000: 48f (0) 0001: 96f (1) 0002: 360f (2)	—
68	RR INPUT SPECIAL FUNCTION SELECT		0 / 1	00E0	0000: Standard (0) 0040: Fmax (1) 0080: TACC/TDEC mult. (2) 00C0: VB mult. Factor (3) 0020: CL mult. Factor (4)	—

Table 5: Input Terminal Selections

Setting Value	Data (Hex)	Function	Setting Value	Data (Hex)	Function
0	10C8	R (reverse run)	28	04AF	Binary bit #6
1	011C	SS1 (preset speed selection)	29	08AF	Binary bit #7
2	021C	SS2 (preset speed selection)	30	10AF	Binary bit #8
3	041C	SS3 (preset speed selection)	31	20AF	Binary bit #9
4	081C	SS4 (preset speed selection)	32	40AF	Binary bit #10
5	20C8	F (forward run)	33	04CE	No effect
6	201B	RES (fault reset)	34	01C7	UP/DOWN frequency setting (UP)
7	C0C9	ST (gate ON/OFF)	35	02C7	UP/DOWN frequency setting (DOWN)
8	0CC8	JOG selection	36	04C7	UP/DOWN frequency clear
9	081A	Acc/dec #1/#2 selection	37	08C7	PUSH-type RUN key
10	101B	Emergency off	38	10C7	PUSH-type STOP key
11	021B	DC injection braking ON/OFF	39	02B9	No effect
12	041B	Fundamental parameter switching (V/F #2)	40	C0C8	Forward/reverse run selection
13	011B	Feedback control ON/OFF	41	20C7	RUN
14	10CE	Pattern run selection #1	42	30C9	Binary data write
15	20CE	Pattern run selection #2	43	0198	[LOCAL/REMOTE] key
16	40CE	Pattern run selection #3	44	0298	[MON] key
17	80CE	Pattern run selection #4	45	0498	[PRG] key
18	02CE	Pattern run continue signal	46	0898	[UP] (▲) key
19	01CE	Pattern run step trigger signal	47	1098	[DOWN] (▼) key
20	0AC9	JOG forward run	48	2098	[READ/WRITE] key
21	06C9	JOG reverse run	49	4098	[RUN] key
22	10AE	Binary bit #0	50	8098	[STOP/CLEAR] key
23	20AE	Binary bit #1	51	08CE	Commercial power / inverter switching signal
24	40AE	Binary bit #2	52	40C7	Reserved for option use
25	80AE	Binary bit #3	53	10CB	RR frequency switching input
26	01AF	Binary bit #4	54	20CB	IV frequency switching input
27	02AF	Binary bit #5			

Note: In order for binary bit #0 ~ #10 (setting values 22 ~ 32) and UP/DOWN frequency setting (setting values 34 & 35) inputs to be valid, parameter FREQUENCY PRIORITY SELECTION #1 or FREQUENCY PRIORITY SELECTION #2 in GROUP: FREQUENCY SETTING PARAMETERS must be set to 5 (BIN (binary setting or UP/DOWN setting)).

Table 6: Output Terminal Selections (RCH, LOW, FL, OUT relay contacts)

Setting Value	Data (Hex)	Function	Setting Value	Data (Hex)	Function
0	0000	Lower limit frequency	32	C5B7	Executing emergency off
1	0100	/Lower limit frequency	33	CDB7	/Executing emergency off
2	0200	Upper limit frequency	34	B5BB	Executing retry
3	0300	/Upper limit frequency	35	BDBB	/Executing retry
4	0400	Low speed signal	36	D5CF	Pattern run switching output
5	0500	/Low speed signal	37	DDCF	/Pattern run switching output
6	0600	Accel/decel complete	38	D5D8	PID deviation limit
7	0700	/Accel/decel complete	39	DDD8	/PID deviation limit
8	0800	Selected speed reach signal	40	C5BB	Run/stop
9	0900	/Selected speed reach signal	41	CDBB	/Run/stop
10	0A00	Fault	42	1400	Severe fault (armature short, load-end short, open phase, output error, earth fault)
11	0B00	/Fault	43	1500	/Severe fault (armature short, load-end short, open phase, output error, earth fault)
12	0C00	Fault other than earth fault or load-end overcurrent	44	1600	Non-severe fault (overload, overcurrent, overvoltage)
13	0D00	/Fault other than earth fault or load-end overcurrent	45	1700	/Non-severe fault (overload, overcurrent, overvoltage)
14	95B5	Overcurrent pre-alarm	46	E5D8	Commercial power / inverter sw itching output #1
15	9DB5	/Overcurrent pre-alarm	47	EDD8	/Commercial power / inverter switching output #1
16	85C5	Inverter overload pre-alarm	48	F5D8	Commercial power / inverter switching output #2
17	8DC5	/Inverter overload pre-alarm	49	FDD8	/Commercial power / inverter switching output #2
18	95C5	Motor overload pre-alarm	50	85C0	Fan ON/OFF
19	9DC5	/Motor overload pre-alarm	51	8DC0	/Fan ON/OFF
20	D5C5	Overheat pre-alarm	52	F5B6	Executing JOG
21	DDC5	/Overheat pre-alarm	53	FDB6	/Executing JOG
22	A5B4	Overvoltage pre-alarm	54	1800	Local/remote operation
23	ADB4	/Overvoltage pre-alarm	55	1900	/Local/remote operation
24	E5B4	Undervoltage alarm	56	A5D1	Cumulative timer alarm
25	EDB4	/Undervoltage alarm	57	ADD1	/Cumulative timer alarm
26	85B5	Undercurrent alarm	58	1A00	Communication error alarm
27	8DB5	/Undercurrent alarm	59	1B00	/Communication error alarm
28	85D1	Overtorque alarm	60	A5B6	F/R
29	8DD1	/Overtorque alarm	61	ADB6	/F/R
30	E5BB	Braking resistor OL pre-alarm	62	1E00	Run preparation complete
31	EDBB	/Braking resistor OL pre-alarm	63	1F00	/Run preparation complete

9.3.5 GROUP:SPECIAL CONTROL PARAMETERS

Register	Function / Title	Bank	Mask	Adjustment Range	Multiplier
69	START-UP FREQUENCY	0 / 1	FFFF	0000 ~ 03E8 (0.00 ~ 10.00)	0.01
6A ~ 6F	Reserved	—	—	—	—
70	END FREQUENCY	0 / 1	FFFF	0000 ~ 0BB8 (0.00 ~ 30.00)	0.01
71	RUN FREQUENCY	0 / 1	FFFF	0000 ~ Fmax	0.01
72	RUN FREQUENCY HYSTERESIS	0 / 1	FFFF	0000 ~ 0BB8 (0.00 ~ 30.00)	0.01
73	ENABLE JUMP FREQUENCIES	0 / 1	0080	0000: Function OFF (0) 0080: Function ON (1)	—
74	1 JUMP FREQUENCY #1	0 / 1	FFFF	0000 ~ Fmax	0.01
75	JUMP FREQUENCY #1 BANDWIDTH	0 / 1	FFFF	0000 ~ 0BB8 (0.00 ~ 30.00)	0.01
76	JUMP FREQUENCY #2	0 / 1	FFFF	0000 ~ Fmax	0.01
77	JUMP FREQUENCY #2 BANDWIDTH	0 / 1	FFFF	0000 ~ 0BB8 (0.00 ~ 30.00)	0.01
78	JUMP FREQUENCY #3	0 / 1	FFFF	0000 ~ Fmax	0.01
79	JUMP FREQUENCY #3 BANDWIDTH	0 / 1	FFFF	0000 ~ 0BB8 (0.00 ~ 30.00)	0.01
7A ~ 7F	Reserved	—	—	—	—
80	PWM CARRIER FREQUENCY (Note 1)	0 / 1	00FF	0005 ~ 0064 (0.5 ~ 10.0)	0.1

Note 1: Actual adjustment range depends on inverter rating.

9.3.6 GROUP:FREQUENCY SETTING PARAMETERS

Register	Function / Title		Bank	Mask	Adjustment Range	Multiplier
81	FREQUENCY PRIORITY SELECTION #1		0 / 1	0007	0001: RR (1) 0002: IV (2) 0003: RX (3) 0004: PG (4) 0005: BIN (5)	—
82	FREQUENCY PRIORITY SELECTION #2		0 / 1	0038	0008: RR (1) 0010: IV (2) 0018: RX (3) 0020: PG (4) 0028: BIN (5)	—
83	ANALOG INPUT FILTER		0 / 1	0003	0000: No filter (0) 0001: Small filter (1) 0002: Medium filter (2) 0003: Large filter (3)	—
84	RR TERMINAL STANDARD OR ADJUSTABLE		0 / 1	0002	0000: Standard (0) 0002: Adjustable (1)	—
85	1	RR REFERENCE SETTING POINT #1	0 / 1	00FF	0000 ~ 0064 (0 ~ 100)	1
86		RR REF POINT #1 FREQUENCY	0 / 1	FFFF	0000 ~ Fmax	0.01
87		RR REFERENCE SETTING POINT #2	0 / 1	00FF	0000 ~ 0064 (0 ~ 100)	1
88		RR REF POINT #2 FREQUENCY	0 / 1	FFFF	0000 ~ Fmax	0.01
89	IV TERMINAL STANDARD OR ADJUSTABLE		0 / 1	0004	0000: Standard (0) 0004: Adjustable (1)	—
8A	1	IV REFERENCE SETTING POINT #1	0 / 1	00FF	0000 ~ 0064 (0 ~ 100)	1
8B		IV REF POINT #1 FREQUENCY	0 / 1	FFFF	0000 ~ Fmax	0.01
8C		IV REFERENCE SETTING POINT #2	0 / 1	00FF	0000 ~ 0064 (0 ~ 100)	1
8D		IV REF POINT #2 FREQUENCY	0 / 1	FFFF	0000 ~ Fmax	0.01
8E	RX TERMINAL STANDARD OR ADJUSTABLE		0 / 1	0008	0000: Standard (0) 0008: Adjustable (1)	—
8F	1	RX REFERENCE SETTING POINT #1	0 / 1	00FF	009C ~ 00FF, 0000 ~ 0064 (-100 ~ -1, 0 ~ 100)	1
90		RX REF POINT #1 FREQUENCY	0 / 1	FFFF	-Fmax ~ Fmax	0.02
91		RX REFERENCE SETTING POINT #2	0 / 1	00FF	009C ~ 00FF, 0000 ~ 0064 (-100 ~ -1, 0 ~ 100)	1
92		RX REF POINT #2 FREQUENCY	0 / 1	FFFF	-Fmax ~ Fmax	0.02
93	PG TERMINAL STANDARD OR ADJUSTABLE		0 / 1	0010	0000: Standard (0) 0010: Adjustable (1)	—
94	1	PG REFERENCE SETTING POINT #1	0 / 1	00FF	009C ~ 00FF, 0000 ~ 0064 (-100 ~ -1, 0 ~ 100)	1
95		PG REF POINT #1 FREQUENCY	0 / 1	FFFF	-Fmax ~ Fmax	0.02
96		PG REFERENCE SETTING POINT #2	0 / 1	00FF	009C ~ 00FF, 0000 ~ 0064 (-100 ~ -1, 0 ~ 100)	1
97		PG REF POINT #2 FREQUENCY	0 / 1	FFFF	-Fmax ~ Fmax	0.02

Register	Function / Title		Bank	Mask	Adjustment Range	Multiplier
98	BINARY INPUT STD OR ADJUSTABLE		0 / 1	0001	0000: Standard (0) 0001: Adjustable (1)	—
99	1	BINARY REF SETTING POINT #1	0 / 1	00FF	0000 ~ 0064 (0 ~ 100)	1
9A		BINARY REF POINT #1 FREQUENCY	0 / 1	FFFF	-Fmax ~ Fmax	0.02
9B		BINARY REF SETTING POINT #2	0 / 1	00FF	0000 ~ 0064 (0 ~ 100)	1
9C		BINARY REF POINT #2 FREQUENCY	0 / 1	FFFF	-Fmax ~ Fmax	0.02
9D	JOG RUN FREQUENCY		0 / 1	FFFF	0000 ~ 07D0 (0.00 ~ 20.00)	0.01
9E	Other than 0	JOG STOP METHOD	0 / 1	00C0	0000: Decelerated stop (0) 0040: Coast stop (1) 0080: DC injection stop (2)	—
9F	PRESET SPEED SELECTION		0 / 1	000F	0000 ~ 000F (0 ~ 15)	1
A0 ~ FF	Reserved		—	—	—	—
100	Other than 0	PRESET SPEED MODE ACTIVATION	0 / 1	0004	0000: Deactivated (0) 0004: Activated (1)	—
101		PRESET SPEED #1 FREQUENCY	1	FFFF	LL ~ UL	0.01
102		PRESET SPEED #1 OPERATING MODE	1	040C	0004: (0) 0000: (1) 000C: (2) 0008: (3) 0404: (4) 0400: (5) 040C: (6) 0408: (7)	1
103	2 or higher	PRESET SPEED #2 FREQUENCY	1	FFFF	LL ~ UL	0.01
104		PRESET SPEED #2 OPERATING MODE	1	040C	Same as PRESET SPEED #1 OPERATING MODE	1
105	3 or higher	PRESET SPEED #3 FREQUENCY	1	FFFF	LL ~ UL	0.01
106		PRESET SPEED #3 OPERATING MODE	1	040C	Same as PRESET SPEED #1 OPERATING MODE	1
107	4 or higher	PRESET SPEED #4 FREQUENCY	1	FFFF	LL ~ UL	0.01
108		PRESET SPEED #4 OPERATING MODE	1	040C	Same as PRESET SPEED #1 OPERATING MODE	1
109	5 or higher	PRESET SPEED #5 FREQUENCY	1	FFFF	LL ~ UL	0.01
10A		PRESET SPEED #5 OPERATING MODE	1	040C	Same as PRESET SPEED #1 OPERATING MODE	1
10B	6 or higher	PRESET SPEED #6 FREQUENCY	1	FFFF	LL ~ UL	0.01
10C		PRESET SPEED #6 OPERATING MODE	1	040C	Same as PRESET SPEED #1 OPERATING MODE	1
10D	7 or higher	PRESET SPEED #7 FREQUENCY	1	FFFF	LL ~ UL	0.01
10E		PRESET SPEED #7 OPERATING MODE	1	040C	Same as PRESET SPEED #1 OPERATING MODE	1

Register	Function / Title		Bank	Mask	Adjustment Range	Multiplier
10F	8 or higher	PRESET SPEED #8 FREQUENCY	1	FFFF	LL ~ UL	0.01
110		PRESET SPEED #8 OPERATING MODE	1	040C	Same as PRESET SPEED #1 OPERATING MODE	1
111	9 or higher	PRESET SPEED #9 FREQUENCY	1	FFFF	LL ~ UL	0.01
112		PRESET SPEED #9 OPERATING MODE	1	040C	Same as PRESET SPEED #1 OPERATING MODE	1
113	10 or higher	PRESET SPEED #10 FREQUENCY	1	FFFF	LL ~ UL	0.01
114		PRESET SPEED #10 OPERATING MODE	1	040C	Same as PRESET SPEED #1 OPERATING MODE	1
115	11 or higher	PRESET SPEED #11 FREQUENCY	1	FFFF	LL ~ UL	0.01
116		PRESET SPEED #11 OPERATING MODE	1	040C	Same as PRESET SPEED #1 OPERATING MODE	1
117	12 or higher	PRESET SPEED #12 FREQUENCY	1	FFFF	LL ~ UL	0.01
118		PRESET SPEED #12 OPERATING MODE	1	040C	Same as PRESET SPEED #1 OPERATING MODE	1
119	13 or higher	PRESET SPEED #13 FREQUENCY	1	FFFF	LL ~ UL	0.01
11A		PRESET SPEED #13 OPERATING MODE	1	040C	Same as PRESET SPEED #1 OPERATING MODE	1
11B	14 or higher	PRESET SPEED #14 FREQUENCY	1	FFFF	LL ~ UL	0.01
11C		PRESET SPEED #14 OPERATING MODE	1	040C	Same as PRESET SPEED #1 OPERATING MODE	1
11D	15	PRESET SPEED #15 FREQUENCY	1	FFFF	LL ~ UL	0.01
11E		PRESET SPEED #15 OPERATING MODE	1	040C	Same as PRESET SPEED #1 OPERATING MODE	1

9.3.7 GROUP:PROTECTION FUNCTION PARAMETERS

Register	Function / Title		Bank	Mask	Adjustment Range	Multiplier
11F	DYNAMIC BRAKING SELECTION		0 / 1	0003	0000: no dynamic braking (0) 0001: with dynamic braking, no DBR overload trip (1) 0003: with dynamic braking and DBR overload trip (2)	—
120	2	BRAKING RESISTOR VALUE	0 / 1	FFFF	000A ~ 2710 (1.0 ~ 1000)	0.1
121		BRAKING RESISTOR POWER RATING	0 / 1	FFFF	0001 ~ EA60 (0.01 ~ 600.00)	0.01
122	OVERVOLTAGE STALL PROTECTION		0 / 1	0004	0000: ON (0) 0004: OFF (1)	—
123	DC INJECTION START FREQUENCY		0 / 1	FFFF	0000 ~ 2EE0 (0.00 ~ 120.00)	0.01
124	Other than 0	DC INJECTION CURRENT MAGNITUDE	0 / 1	00FF	0000 ~ 0064 (0 ~ 100)	1
125		DC INJECTION TIME	0 / 1	00FF	0000 ~ 0064 (0.0 ~ 10.0)	0.1
126	FWD/REV DC INJECT PRIORITY CTRL		0 / 1	0040	0000: OFF (0) 0040: ON (1)	—
127	MOTOR SHAFT STATIONARY CTRL		0 / 1	0080	0000: OFF (0) 0080: ON (1)	—
128	EMERGENCY OFF MODE SELECTION		0 / 1	0030	0000: Coast stop (0) 0010: Decelerated stop (1) 0020: DC injection stop (2)	—
129	2	EMERGENCY OFF DC INJECTION TIME	0 / 1	00FF	0000 ~ 0064 (0.0 ~ 10.0)	0.1
12A	NUMBER OF RETRY ATTEMPTS		0 / 1	00FF	0000 ~ 000A (0 ~ 10)	1
12B	Other than 0	TIME BETWEEN RETRY ATTEMPTS	0 / 1	00FF	0000 ~ 0064 (0.0 ~ 10.0)	0.1
12C	REGENERATION POWER RIDE-THROUGH		0 / 1	0008	0000: OFF (0) 0008: ON (1)	—
12D	1	REGEN RIDE-THROUGH TIME	0 / 1	00FF	0000 ~ 00FA (0.0 ~ 25.0)	0.1
12E	AUTO-RESTART (MOTOR SPEED SEARCH)		0 / 1	0018	0000: OFF (0) 0008: On power failure (1) 0010: On ST make/break (2) 0018: Both (1) and (2) (3)	—
12F	ELECTRONIC THERMAL PROTECT LVL #1		0 / 1	00FF	000A ~ 0064 (10 ~ 100)	1
130	OVERLOAD REDUCTION START FREQ		0 / 1	FFFF	0000 ~ 0BB8 (0.00 ~ 30.00)	0.01
131	MOTOR 150% OVERLOAD TIME LIMIT		0 / 1	00FF	0001 ~ 00F0 (10 ~ 2400)	10
132	OVERLOAD SELECTION		0 / 1	0030	0000: with motor overload trip, without soft-stall (0) 0010: with motor overload trip and soft-stall (1) 0020: without soft-stall or motor overload trip (2) 0030: with soft-stall, without motor overload trip (3)	—
133	STALL PROTECTION ENABLE		0 / 1	0040	0000: ON (0) 0040: OFF (1)	—
134	0	STALL PROTECTION CURRENT LEVEL	0 / 1	00FF	000A ~ 00D7 (10 ~ 215)	1

Register	Function / Title	Bank	Mask	Adjustment Range	Multiplier
135	UNDERVOLTAGE TRIP SELECTION	0 / 1	0080	0000: Trip disabled (0) 0080: Trip (during run) (1)	—
136	UNDERVOLTAGE DETECT TIME	0 / 1	FFFF	0000 ~ 03E8 (0.00 ~ 10.00)	0.01
137	LOW CURRENT DETECT SELECTION	0 / 1	0008	0000: Trip disabled (0) 0008: Trip on detection (1)	—
138	LOW CURRENT DETECT LEVEL	0 / 1	00FF	0000 ~ 0064 (0 ~ 100)	1
139	LOW CURRENT DETECTION TIME	0 / 1	00FF	0000 ~ 00FF (0 ~ 255)	1
140	OUTPUT SHORT-CIRCUIT DETECTION SELECT	0 / 1	0003	0000: Standard motor (0) 0001: High-speed motor (1) 0002: Positioning use (standard motor) (2) 0003: Positioning use (high-speed motor) (3)	—
141	OVERTORQUE TRIP SELECTION	0 / 1	0040	0000: Trip disabled (0) 0040: Trip enabled (1)	—
142	OVERTORQUE TRIP LEVEL	0 / 1	00FF	0000 ~ 00C8 (0 ~ 200)	1
143	FAULT TRIP EEPROM SAVE ENABLE	0 / 1	0002	0000: Data cleared when powered OFF (0) 0002: Data retained when powered OFF (1)	—
144	COOLING FAN CONTROL SELECTION	0 / 1	0004	0000: Automatic (temperature detection) (0) 0004: Always ON (1)	—
145	CUMULATIVE RUN TIMER ALARM SETTING	0 / 1	FFFF	0000 ~ C34B (0.00 ~ 999.90)	0.02

9.3.8 GROUP:PATTERN RUN CONTROL PARAMETERS

Register	Function / Title	Bank	Mask	Adjustment Range	Multiplier
146	PATTERN RUN SELECTION	0 / 1	0008	0000: OFF (0) 0008: ON (1)	—
147	1 PATTERN RUN CONTINUE MODE	0 / 1	0001	0000: reset on stop (0) 0001: switch when done (1)	—
148	PATTERN GROUP #1 SPEED #0	1	00FF	0000: Skip (0) 0001 ~ 000F: Speeds 1 ~ 15	1
149	PATTERN GROUP #1 SPEED #1				
150	PATTERN GROUP #1 SPEED #2				
151	PATTERN GROUP #1 SPEED #3				
152	PATTERN GROUP #1 SPEED #4				
153	PATTERN GROUP #1 SPEED #5				
154	PATTERN GROUP #1 SPEED #6				
155	PATTERN GROUP #1 SPEED #7				
156	PATTERN GROUP #1 NUMBER OF CYCLES	0 / 1	00FF	0001 ~ 00FF: 1 ~ 255	1
157	PATTERN GROUP #2 SPEED #0	1	00FF	0000: Skip (0) 0001 ~ 000F: Speeds 1 ~ 15	1
158	PATTERN GROUP #2 SPEED #1				
159	PATTERN GROUP #2 SPEED #2				
15A	PATTERN GROUP #2 SPEED #3				
15B	PATTERN GROUP #2 SPEED #4				
15C	PATTERN GROUP #2 SPEED #5				
15D	PATTERN GROUP #2 SPEED #6				
15E	PATTERN GROUP #2 SPEED #7				
15F	PATTERN GROUP #2 NUMBER OF CYCLES	0 / 1	00FF	0001 ~ 00FF: 1 ~ 255	1
160	PATTERN GROUP #3 SPEED #0	1	00FF	0000: Skip (0) 0001 ~ 000F: Speeds 1 ~ 15	1
161	PATTERN GROUP #3 SPEED #1				
162	PATTERN GROUP #3 SPEED #2				
163	PATTERN GROUP #3 SPEED #3				
164	PATTERN GROUP #3 SPEED #4				
165	PATTERN GROUP #3 SPEED #5				
166	PATTERN GROUP #3 SPEED #6				
167	PATTERN GROUP #3 SPEED #7				
168	PATTERN GROUP #3 NUMBER OF CYCLES	0 / 1	00FF	0001 ~ 00FF: 1 ~ 255	1

Register	Function / Title	Bank	Mask	Adjustment Range	Multiplier
169	PATTERN GROUP #4 SPEED #0	1	00FF	0000: Skip (0) 0001 ~ 000F: Speeds 1 ~ 15	1
16A	PATTERN GROUP #4 SPEED #1				
16B	PATTERN GROUP #4 SPEED #2				
16C	PATTERN GROUP #4 SPEED #3				
16D	PATTERN GROUP #4 SPEED #4				
16E	PATTERN GROUP #4 SPEED #5				
16F	PATTERN GROUP #4 SPEED #6				
170	PATTERN GROUP #4 SPEED #7				
171	PATTERN GROUP #4 NUMBER OF CYCLES	0 / 1	00FF	0001 ~ 00FF: 1 ~ 255	1
172	SPEED #1 CONTINUE MODE	1	00FF	0000: Count in seconds from time of activation (0) 0001: Count in minutes from time of activation (1) 0002: Count in seconds from speed reach (2) 0003: Count in minutes from speed reach (3) 0004: Non-stop (continue until STOP command) (4) 0005: Continue until next step command (5)	—
173	< 4 SPEED #1 DRIVE TIME	1	FFFF	0000 ~ 1F40 (0 ~ 8000)	1
174	SPEED #2 CONTINUE MODE	1	00FF	Same as SPEED #1 CONTINUE MODE	—
175	< 4 SPEED #2 DRIVE TIME	1	FFFF	0000 ~ 1F40 (0 ~ 8000)	1
176	SPEED #3 CONTINUE MODE	1	00FF	Same as SPEED #1 CONTINUE MODE	—
177	< 4 SPEED #3 DRIVE TIME	1	FFFF	0000 ~ 1F40 (0 ~ 8000)	1
178	SPEED #4 CONTINUE MODE	1	00FF	Same as SPEED #1 CONTINUE MODE	—
179	< 4 SPEED #4 DRIVE TIME	1	FFFF	0000 ~ 1F40 (0 ~ 8000)	1
17A	SPEED #5 CONTINUE MODE	1	00FF	Same as SPEED #1 CONTINUE MODE	—
17B	< 4 SPEED #5 DRIVE TIME	1	FFFF	0000 ~ 1F40 (0 ~ 8000)	1
17C	SPEED #6 CONTINUE MODE	1	00FF	Same as SPEED #1 CONTINUE MODE	—
17D	< 4 SPEED #6 DRIVE TIME	1	FFFF	0000 ~ 1F40 (0 ~ 8000)	1
17E	SPEED #7 CONTINUE MODE	1	00FF	Same as SPEED #1 CONTINUE MODE	—
17F	< 4 SPEED #7 DRIVE TIME	1	FFFF	0000 ~ 1F40 (0 ~ 8000)	1
180	SPEED #8 CONTINUE MODE	1	00FF	Same as SPEED #1 CONTINUE MODE	—
181	< 4 SPEED #8 DRIVE TIME	1	FFFF	0000 ~ 1F40 (0 ~ 8000)	1

Register	Function / Title		Bank	Mask	Adjustment Range	Multiplier
182	SPEED #9 CONTINUE MODE		1	00FF	Same as SPEED #1 CONTINUE MODE	—
183	< 4	SPEED #9 DRIVE TIME	1	FFFF	0000 ~ 1F40 (0 ~ 8000)	1
184	SPEED #10 CONTINUE MODE		1	00FF	Same as SPEED #1 CONTINUE MODE	—
185	< 4	SPEED #10 DRIVE TIME	1	FFFF	0000 ~ 1F40 (0 ~ 8000)	1
186	SPEED #11 CONTINUE MODE		1	00FF	Same as SPEED #1 CONTINUE MODE	—
187	< 4	SPEED #11 DRIVE TIME	1	FFFF	0000 ~ 1F40 (0 ~ 8000)	1
188	SPEED #12 CONTINUE MODE		1	00FF	Same as SPEED #1 CONTINUE MODE	—
189	< 4	SPEED #12 DRIVE TIME	1	FFFF	0000 ~ 1F40 (0 ~ 8000)	1
18A	SPEED #13 CONTINUE MODE		1	00FF	Same as SPEED #1 CONTINUE MODE	—
18B	< 4	SPEED #13 DRIVE TIME	1	FFFF	0000 ~ 1F40 (0 ~ 8000)	1
18C	SPEED #14 CONTINUE MODE		1	00FF	Same as SPEED #1 CONTINUE MODE	—
18D	< 4	SPEED #14 DRIVE TIME	1	FFFF	0000 ~ 1F40 (0 ~ 8000)	1
18E	SPEED #15 CONTINUE MODE		1	00FF	Same as SPEED #1 CONTINUE MODE	—
18F	< 4	SPEED #15 DRIVE TIME	1	FFFF	0000 ~ 1F40 (0 ~ 8000)	1

9.3.9 GROUP:FEEDBACK CONTROL PARAMETERS

Register	Function / Title		Bank	Mask	Adjustment Range	Multiplier
190	FEEDBACK CONTROL SELECTION		0 / 1	0060	0020: No feedback (0) 0040: PID control (1) 0060: Speed feedback (2)	—
191	1, 2	FEEDBACK INPUT SIGNAL SELECTION	0 / 1	001C	0004: RR input (1) 0008: IV input (2) 000C: RX input (3) 0010: PG feedback (4) 0014: RS232C input (5) 0018: Communication/12-bit binary interface board (6) 001C: BIN input (7)	—
192		PROPORTIONAL GAIN	0 / 1	00FF	0001 ~ 00FF (0.01 ~ 2.55)	0.01
193		INTEGRAL GAIN	0 / 1	FFFF	0001 ~ 8CA0 (0.01 ~ 360.00)	0.01
194		ANTI-HUNTING GAIN	0 / 1	00FF	0000 ~ 00FF (0.0 ~ 25.5)	0.1
195		LAG TIME CONSTANT	0 / 1	00FF	0000 ~ 00FF (0 ~ 255)	1
196		PID LOWER LIMIT FREQUENCY	0 / 1	FFFF	0 ~ Fmax	0.01
197		PID DEVIATION LIMIT SELECTION		0 / 1	0080	0000: No PID deviation limit (0) 0080: PID deviation limited (1)
198	1	PID DEVIATION UPPER LIMIT	0 / 1	00FF	0000 ~ 0032 (0 ~ 50)	1
199		PID DEVIATION LOWER LIMIT	0 / 1	00FF	0000 ~ 0032 (0 ~ 50)	1
19A	PG INPUT: NUMBER OF PULSES		0 / 1	FFFF	0001 ~ 270F (1 ~ 9999)	1
19B	PG INPUT: NUMBER OF PHASES		0 / 1	0001	0000: Single-phase input (1) 0001: Two-phase input (2)	—
19C	DROOPING CONTROL ENABLE		0 / 1	0002	0000: OFF (0) 0002: ON (1)	—
19D	1	DROOPING CONTROL AMOUNT	0 / 1	00FF	0000 ~ 0064 (0 ~ 10.0)	0.1
19E	OVERRIDE CONTROL SELECTION		0 / 1	0007	0000: OFF (0) 0001: FCRR (1) 0002: FCIV (2) 0003: FCRX (3) 0004: FCPG (4) 0005: FCPNL (5) 0006: FCOPT (6) 0007: FCMLT (7)	—
19F	7	OVERRIDE MULTIPLIER INPUT SELECTION	0 / 1	0038	0000: Reference (0) 0008: KRR (1) 0010: KIV (2) 0018: KRX (3) 0020: KBIN (4)	—
1A0		OVERRIDE CHANGE MULTIPLIER	0 / 1	FFFF	FC18 ~ 03E8 (-100.0 ~ 100.0)	0.1
1A1 ~ 1CF	Reserved		—	—	—	—

9.3.10 GROUP:COMMUNICATION SETTING PARAMETERS

Register	Function / Title		Bank	Mask	Adjustment Range	Multiplier			
1D0	Loss of communications timeout time		1	—	100 ~ 60000 (0.100s ~ 60.000s)	0.001			
1D1	Loss of communications timeout action		1	—	0 ~ 4	—			
1D2	Response delay time		1	—	0 ~ 2000 (0s ~ 2.000s)	0.001			
1D3 ~ 200	Reserved		—	—	—	—			
201	RS232 BAUD RATE		1	0018	0000: 2400 baud (0) 0008: 4800 baud (1) 0010: 9600 baud (2)	—			
202	NUMBER OF DATA BITS		1	0040	0000: 7 bits (0) 0040: 8 bits (1)	—			
.203	PARITY SETTING		1	0080	0000: Even parity (0) 0080: Odd parity (1)	—			
204	INVERTER ID NUMBER		1	00FF	0000 ~ 00FF (0 ~ 255)	1			
205	COMMUNICATION SELECTION		1	0007	0000: OFF (0) 0001: RS485 (1) 0002: Modbus, F10, DeviceNet (2) 0003: TOSLINE S-20 (3) 0004: 12 bit binary input (4) 0005: 3-digit BCD (0.1Hz) (5) 0006: 3-digit BCD (1Hz) (6)	—			
206	1	MASTER/SLAVE SELECTION	1	0018	0000: Slave (0) 0008: Master (frequency command) (1) 0010: Master (output frequency)(2)	—			
207		RS485 BAUD RATE			1		0004	0000: Normal mode (0) 0004: High-speed mode (1)	
208	2	TOSLINE-F10 COMMAND INPUT	1	0003	0000: OFF (0) 0001: Frequency command (1) 0002: Command input (2) 0003: Both (1) and (2) (3)	—			
209		TOSLINE-F10 MONITOR OUTPUT			1		003C	0000: (0) 0020: (8) 0004: (1) 0024: (9) 0008: (2) 0028: (10) 000C: (3) 002C: (11) 0010: (4) 0030: (12) 0014: (5) 0034: (13) 0018: (6) 0038: (14) 001C: (7) 003C: (15)	—
20A		TOSLINE-F10 COMM ERROR MODE			1		0080	0000: Data cleared (0) 0080: Data retained (1)	—
20B	3	TOSLINE-S20 RECEIVE ADDRESS	1	FFFF	0000 ~ 03FF (0 ~ 1023)	1			
20C		TOSLINE-S20 TRANSMIT ADDRESS	1	FFFF	0000 ~ 03FF (0 ~ 1023)	1			
20D		TOSLINE-S20 COMMAND INPUT	1	001F	0000 ~ 001F (0 ~ 31)	1			
20E		TOSLINE-S20 MONITOR OUTPUT	1	001F	0000 ~ 001F (0 ~ 31)	1			
20F		TOSLINE-S20 FREQ REF ADDR SELECT	1	0001	0000: Disable (0) 0001: Enable (1)	1			
210		1	TOSLINE-S20 FREQ REF ADDR	1	FFFF	0000 ~ 03FF (0 ~ 1023)	1		

Register	Function / Title	Bank	Mask	Adjustment Range	Multiplier
211	TOSLINE-S20 COMM ERROR MODE	1	0002	0000: Data cleared (0) 0002: Data retained (1)	1
212	TOSLINE-S20 COMM OPTION RESET	1	0004	0000: No effect (0) 0004: Reset (1)	1
213	RS485/12-BIT BINARY BIAS, GAIN	0 / 1	0020	0000: OFF (0) 0020: ON (1)	—
214	1 RS485/12-BIT BINARY POINT #1	0 / 1	00FF	0000 ~ 0064 (0 ~ 100)	1
215	RS485/12-BIT BINARY PT. #1 FREQ	0 / 1	FFFF	0000 ~ Fmax (0 ~ Fmax)	0.01
216	RS485/12-BIT BINARY POINT #2	0 / 1	00FF	0000 ~ 0064 (0 ~ 100)	1
217	RS485/12-BIT BINARY PT. #2 FREQ	0 / 1	FFFF	0000 ~ Fmax (0 ~ Fmax)	0.01

Note: Registers 1D0 ~ 1D2 are not standard G3 parameters accessible via the LCD keypad. They are Modbus-specific parameters that are only accessible via the Modbus network.

9.3.11 GROUP:AM/FM TERMINAL ADJUSTMENT PARAMS

Register	Function / Title	Bank	Mask	Adjustment Range	Multiplier
218	FM TERMINAL FUNCTION SELECTION	0 / 1	FFFF	1194: Pre-comp ref. frequency (0) 6686: Post-comp output freq. (1) 1500: Frequency setting (2) 2576: Output current (3) 2689: DC voltage (4) 5668: Output voltage (5) 3684: Torque current (6) 2688: Excitation current (7) 7506: PID feedback value (8) 0584: Motor overload ratio (9) 0586: Inverter overload ratio (10) 0588: DBR overload ratio (11) 835C: Input power (12) 835E: Output power (13) A000: Fixed output (14) 2304: Peak output current (15) 8302: Peak input voltage (16)	—
219	FREQUENCY METER ADJUSTMENT	0 / 1	FFFF	0000 ~ FFFF	1
21A	AM TERMINAL FUNCTION SELECTION	0 / 1	FFFF	Same as FM TERMINAL FUNCTION SELECTION	—
21B	CURRENT METER ADJUSTMENT	0 / 1	FFFF	0000 ~ FFFF	1

9.3.12 GROUP:UTILITY PARAMETERS

Register	Function / Title	Bank	Mask	Adjustment Range	Multiplier
21C	INDUSTRIAL APPLICATIONS (previous setting monitor for read use only)	0 / 1	00FF	0000: Std. Shpmt. setting (0) 0001: Pump application (1) 0002: Fan application (2) 0003: Conveyor application (3) 0004: Hoist application (4) 0005: Textiles application (5) 0006: Machine tools appl. (6)	—
21D	INDUSTRIAL APPLICATIONS (for write use) (*)	0 / 1	00FF	0000: Does nothing (0) 0011: Pump application (1) 0012: Fan application (2) 0013: Conveyor application (3) 0014: Hoist application (4) 0015: Textiles application (5) 0016: Machine tools appl. (6)	—
21E	STANDARD SETTING MODE SELECTION (*)	0 / 1	00FF	0000: Does nothing (0) 0001: 50Hz std. Settings (1) 0002: 60Hz std. Settings (2) 0003: Factory settings (3) 0004: Trip clear (4) 0005: Save user-set param. (5) 0006: TYPE 5 reset (6) 0007: Initialize typeform (7)	—
21F	COMMAND MODE SELECTION	0 / 1	0007	0000: Only RS232C valid (0) 0001: Terminal input valid (1) 0002: Panel input valid (2) 0003: Communication interface input valid (3) 0004: local/remote valid (4)	—
220	FREQUENCY MODE SELECTION	0 / 1	0038	0000: Only RS232C valid (0) 0008: Terminal input valid (1) 0010: Panel input valid (2) 0018: Communication/12-bit binary interface input valid (3) 0020: local/remote valid (4)	—
221	PANEL OPERATION MODE SELECTION	0 / 1	00FB	0000 ~ 003F (0 ~ 63) (except 0004, 0008, 000C....)	1
222	PASS NUMBER	0 / 1	00FF	0000 ~ 0063 (0 ~ 99)	1
223	CPU VERSION	2	FFFF	(Monitor only)	—
224	ROM VERSION	3	FFFF	(Monitor only)	—
225	EEPROM VERSION	1	FFFF	(Monitor only)	—
226	INVERTER TYPEFORM	0	00FF	(Monitor only)	—
227	STATUS MONITOR #1 DISPLAY SELECT	0 / 1	FFFF	0001 ~ 0010 (1 ~ 16)	1
228	STATUS MONITOR #2 DISPLAY SELECT	0 / 1	FFFF	0001 ~ 0010 (1 ~ 16)	1
229	STATUS MONITOR #3 DISPLAY SELECT	0 / 1	FFFF	0001 ~ 0010 (1 ~ 16)	1
22A	STATUS MONITOR #4 DISPLAY SELECT	0 / 1	FFFF	0001 ~ 0010 (1 ~ 16)	1
22B	FREQUENCY UNITS SCALE FACTOR	0 / 1	FFFF	0000 ~ 4E20 (0.00 ~ 200.00)	0.01
22C	FREQUENCY DISPLAY RESOLUTION	0 / 1	0003	0000: 1Hz (0) 0001: 0.1Hz (1) 0002: 0.01Hz (2)	—

Register	Function / Title	Bank	Mask	Adjustment Range	Multiplier	
22D	ACC/DEC TIME UNITS SELECTION	0 / 1	0004	0000: 0.1 sec. (0) 0004: 0.01 sec. (1)	—	
22E	CURRENT UNITS SELECTION	0 / 1	0008	0000: % (0) 0008: A (1)	—	
22F	VOLTAGE UNITS SELECTION	0 / 1	0010	0000: % (0) 0010: V (1)	—	
230	BLIND FUNCTION SELECTION	0 / 1	0001	0000: Blind (0) 0001: Selective unblinding (1)	—	
231	1 FUNDAMENTAL PARAMS #2 BLIND	0 / 1	0040	0000: Blind (0) 0040: Unblind (1)	—	
232		PANEL CONTROL PARAMS BLIND	0 / 1	0080	0000: Blind (0) 0080: Unblind (1)	—
233		TERMINAL SELECTION PARAMS BLIND	0 / 1	0001	0000: Blind (0) 0001: Unblind (1)	—
234		SPECIAL CONTROL PARAMS BLIND	0 / 1	0002	0000: Blind (0) 0002: Unblind (1)	—
235		FREQUENCY SETTING PARAMS BLIND	0 / 1	0004	0000: Blind (0) 0004: Unblind (1)	—
236		PROTECTION FUNCTION PARAMS BLIND	0 / 1	0008	0000: Blind (0) 0008: Unblind (1)	—
237		PATTERN RUN CONTROL PARAMS BLIND	0 / 1	0010	0000: Blind (0) 0010: Unblind (1)	—
238		FEEDBACK CONTROL PARAMS BLIND	0 / 1	0020	0000: Blind (0) 0020: Unblind (1)	—
239		COMMUNICATION PARAMS BLIND	0 / 1	0040	0000: Blind (0) 0040: Unblind (1)	—
23A		INDUSTRIAL APPL:PUMP PARAMS BLIND	0 / 1	0080	0000: Blind (0) 0080: Unblind (1)	—
23B		INDUSTRIAL APPL:FAN PARAMS BLIND	0 / 1	0001	0000: Blind (0) 0001: Unblind (1)	—
23C		INDUSTRIAL APPL: CONVEYOR BLIND	0 / 1	0002	0000: Blind (0) 0002: Unblind (1)	—
23D		INDUSTRIAL APPL: HOIST BLIND	0 / 1	0004	0000: Blind (0) 0004: Unblind (1)	—
23E		INDUSTRIAL APPL: TEXTILES BLIND	0 / 1	0008	0000: Blind (0) 0008: Unblind (1)	—
23F		INDUST APPL:MACHINE TOOLS BLIND	0 / 1	0010	0000: Blind (0) 0010: Unblind (1)	—
240		AM/FM ADJUSTMENT PARAMS BLIND	0 / 1	0001	0000: Blind (0) 0001: Unblind (1)	—
241		MOTOR PARAMETERS BLIND	0 / 1	0004	0000: Blind (0) 0004: Unblind (1)	—

9.3.13 GROUP:MOTOR RATING PARAMETERS

Register	Function / Title	Bank	Mask	Adjustment Range	Multiplier
242	NUMBER OF MOTOR POLES	0 / 1	00FF	0001: (2) 0002: (4) 0003: (6) 0004: (8) 0005: (10) 0006: (12) 0007: (14) 0008: (16)	2
243	MOTOR RATED CAPACITY	0 / 1	FFFF	0001 ~ 270F (0.1 ~ 999.9)	0.1
244	MOTOR TYPE	0 / 1	0030	0000:Toshiba EQPIII motor (0) 0010:Toshiba STD motor (1) 0020:Other (2)	—
245	2 MOTOR RATED VOLTAGE (230 / 460v units) (575v units)	0 / 1	00FF	0012 ~ 0078 (90 ~ 600)	5
246				001A ~ 00AC (130 ~ 860)	
247	MOTOR RATED FREQUENCY	0 / 1	00FF	0000 ~ 00C8 (0 ~ 400)	2
248	MOTOR RATED RPM	0 / 1	FFFF	0000 ~ 270F (0 ~ 9999)	1
249	AUTO-TUNING ENABLE	0	0008	0000: Auto-tuning disabled (0) 0008: Auto-tuning enabled (1)	—
24A	LOAD MOMENT OF INERTIA	0 / 1	00C0	0000: Small (0) 0040: Medium (1) 0080: Large (2) 00C0: Very large (3)	—

9.3.14 Programmable Pointer Registers

Register	Function / Title	Bank	Mask	Adjustment Range	Multiplier
24B ~ 26A	Programmable Address Registers (32 total)	0	FFFF	1 ~ 24A	—
26B ~ 28A	Programmable Data Registers (32 total)	According to the attributes of the registers programmed in 24B~26A			

9.4 Write-Only Coils

The following write-only “0X” coils are available via the Modbus command 05. These coils access the same bits which are detailed in holding register 02 (refer to section 9.1 of this manual).

Coil	Function	Bank	Function
01	RUN command	DPRAM	OFF: Stop ON: Run
02	STOP Command (has priority over RUN command)		OFF: Run enabled ON: Stop
03	Forward • reverse run selection		OFF: Reverse ON: Forward
04	Acc/dec #1 / #2 selection		OFF: Acc / dec #1 ON: Acc / dec #2
05	Jog mode selection		OFF: Normal (acc/dec mode) ON: Jog mode
06	Feedback control		OFF: Feedback valid ON: Feedback invalid
07	Compulsory DC injection braking mode		OFF: No compulsory DC injection braking ON: Compulsory DC injection below DC INJECTION START FREQUENCY
08	Fundamental parameter switching		OFF: V/F #1 ON: V/F #2
09	Gate block command (coast stop command)		OFF: Normal ON: Gate block
0A	Emergency off command		OFF: Does nothing ON: Emergency off
0B	Reset command (trip clear)		OFF: Does nothing ON: Reset
0C	Reserved		—
0D	Reserved		—
0E	Reserved		—
0F	Reserved	—	
10	Reserved	—	

9.5 Read-Only Coils

The following read-only “0X” coils are available via Modbus command 01. These coils access the same bits which are detailed in holding register 06 (refer to section 9.2 of this manual).

Coil	Function	Bank	Function
11	Run • stop status	DPRAM	OFF: Stopped ON: Running
12	Run enable status		OFF: Run enabled ON: Stopped
13	Forward • reverse status		OFF: Reverse ON: Forward
14	Acc / dec #1 / #2 selection status		OFF: Acc / dec #1 ON: Acc / dec #2
15	Fault status		OFF: Faulted ON: Not faulted
16	Jog mode status		OFF: Normal (acc/dec mode) ON: Jog mode
17	Feedback enable status		OFF: Feedback valid ON: Feedback invalid
18	Compulsory DC injection braking mode status		OFF: DC injection braking inactive ON: DC injection braking active
19	Fundamental parameter switching status		OFF: V/F #1 ON: V/F #2
1A	Coast stop command status		OFF: Normal ON: Coasting to stop
1B	Emergency off command status		OFF: Normal ON: Emergency off
1C	Main circuit undervoltage (MSV) status		OFF: Normal ON: MSV
1D	Reserved		—
1E	Reserved		—
1F	Reserved		—
20	Reserved		—

9.6 Inverter Fault Codes

LCD Display Message	Data (Hex)	Explanation
NO ERROR	xx00	No error has been recorded since the last inverter reset or trip clear
OVERCURRENT (ACCEL) (PRESS CLEAR)	xx01	Overcurrent during acceleration
OVERCURRENT (DECEL) (PRESS CLEAR)	xx02	Overcurrent during deceleration
OVERCURRENT (RUN) (PRESS CLEAR)	xx03	Overcurrent during constant-speed run
LOAD-END OVERCURRENT (PRESS CLEAR)	xx04	Load-end overcurrent detected at start-up (output terminals, motor wiring etc.)
U-PHASE SHORT CKT (PRESS CLEAR)	xx05	U-phase armature short circuit
V-PHASE SHORT CKT (PRESS CLEAR)	xx06	V-phase armature short circuit
W-PHASE SHORT CKT (PRESS CLEAR)	xx07	W-phase armature short circuit
LOST INPUT PHASE (PRESS CLEAR)	xx08	Lost input phase (option)
LOST OUTPUT PHASE (PRESS CLEAR)	xx09	Lost output phase (option)
OVERVOLTAGE (ACCEL) (PRESS CLEAR)	xx0A	Overvoltage during acceleration
OVERVOLTAGE (DECEL) (PRESS CLEAR)	xx0B	Overvoltage during deceleration
OVERVOLTAGE (RUN) (PRESS CLEAR)	xx0C	Overvoltage during constant-speed run
INVERTER OVERLOAD (PRESS CLEAR)	xx0D	Inverter overload
MOTOR OVERLOAD (PRESS CLEAR)	xx0E	Motor overload
DBR OVERLOAD TRIP (PRESS CLEAR)	xx0F	Dynamic braking resistor overload
OVERHEAT TRIP (PRESS CLEAR)	xx10	Inverter overheat
EMERGENCY OFF (PRESS CLEAR)	xx11	Emergency off
EEPROM WRITE FAILURE (PRESS CLEAR)	xx12	EEPROM failure during write
EEPROM READ FAILURE (PRESS CLEAR)	xx13	EEPROM failure during initial read
¾	xx14	Unused
RAM ERROR (PRESS CLEAR)	xx15	RAM error
ROM ERROR (PRESS CLEAR)	xx16	ROM error
CPU ERROR (PRESS CLEAR)	xx17	CPU error
COMMUNICATION ERROR (PRESS CLEAR)	xx18	RS232C timer time-out
GATE ARRAY FAULT (PRESS CLEAR)	xx19	Gate array error

LCD Display Message	Data (Hex)	Explanation
CURRENT DETECT ERROR (PRESS CLEAR)	××1A	Output current detection circuit error
OPTION PCB ERROR (PRESS CLEAR)	××1B	Option PCB error
OPTION ROM ERROR	××1C	Option ROM error
LOW CURRENT TRIP (PRESS CLEAR)	××1D	Low current
UNDERVOLTAGE TRIP (PRESS CLEAR)	××1E	Main circuit undervoltage
$\frac{3}{4}$	××1F	Unused
OVERTORQUE TRIP (PRESS CLEAR)	××20	Overtorque
EARTH FAULT (SOFT) (PRESS CLEAR)	××21	Earth fault (software)
EARTH FAULT (HARD) (PRESS CLEAR)	××22	Earth fault (hardware)
OPEN FUSE TRIP (PRESS CLEAR)	××23	Open fuse
DBR OVERCURRENT TRIP (PRESS CLEAR)	××24	Dynamic braking resistor overcurrent
DC OVERCURRENT (ACC) (PRESS CLEAR)	××25	Overcurrent in DC section during acceleration
DC OVERCURRENT (DEC) (PRESS CLEAR)	××26	Overcurrent in DC section during deceleration
DC OVERCURRENT (RUN) (PRESS CLEAR)	××27	Overcurrent in DC section during constant-speed run
AUTO-TUNING ERROR (PRESS CLEAR)	××28	Auto-tuning error
INV TYPEFORM ERROR (PRESS READ/WRITE)	××29	Inverter typeform error

TOSHIBA

TOSHIBA INTERNATIONAL CORPORATION

INDUSTRIAL DIVISION

13131 West Little York Rd., Houston, TX 77041

Tel: [800] 231-1412 Fax: [713] 466-8773 Telex: 762078

World Wide Web <http://www.tic.toshiba.com>

Printed in U.S.A



INDUSTRIAL CONTROL COMMUNICATIONS