

図面番号 DRAWING NO.  
P6582984

変更記号 REV. MARK

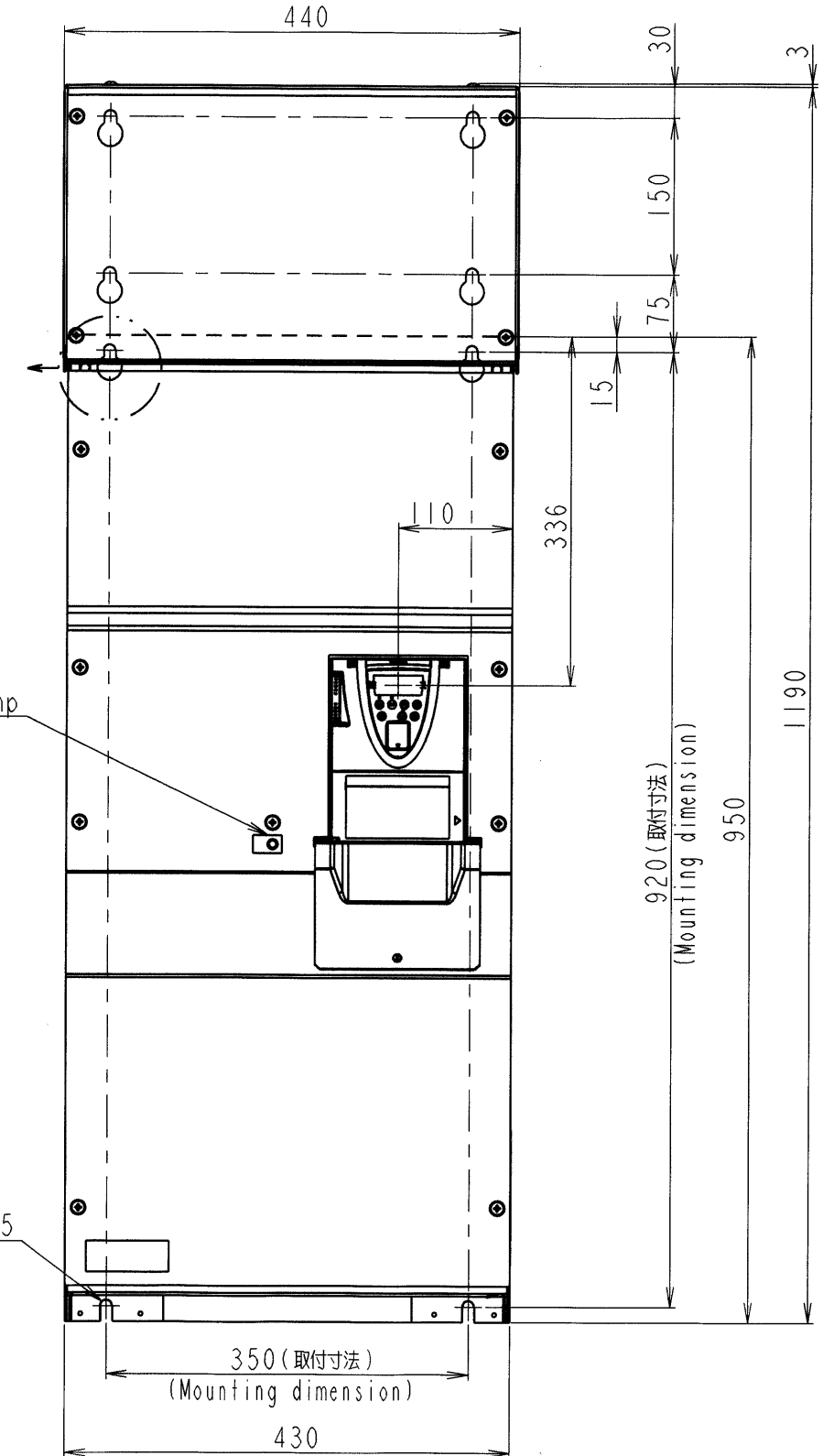
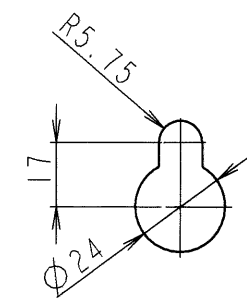

チャージランプ  
Charge lamp

R5.75

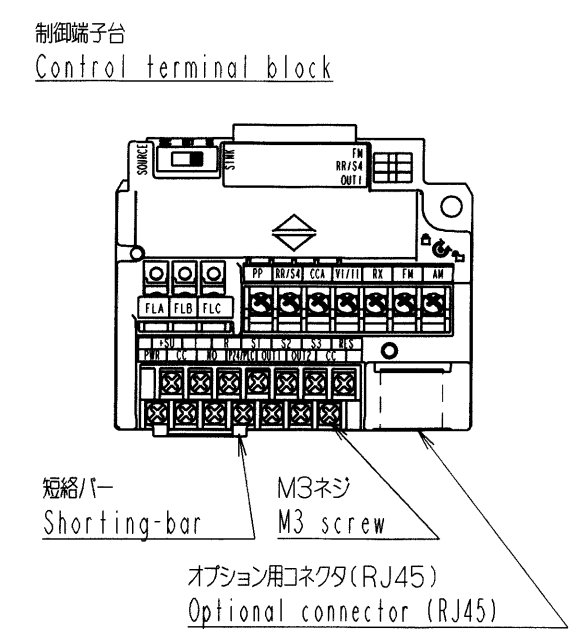
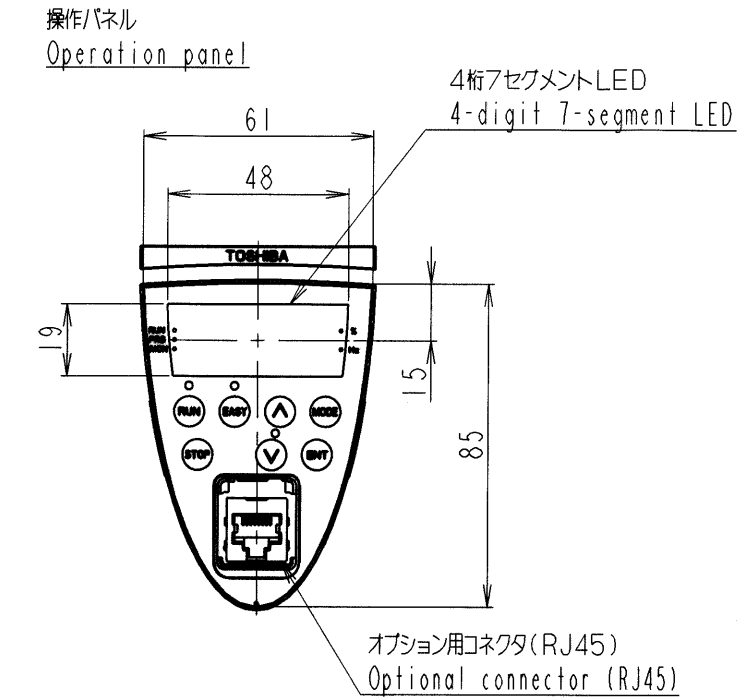
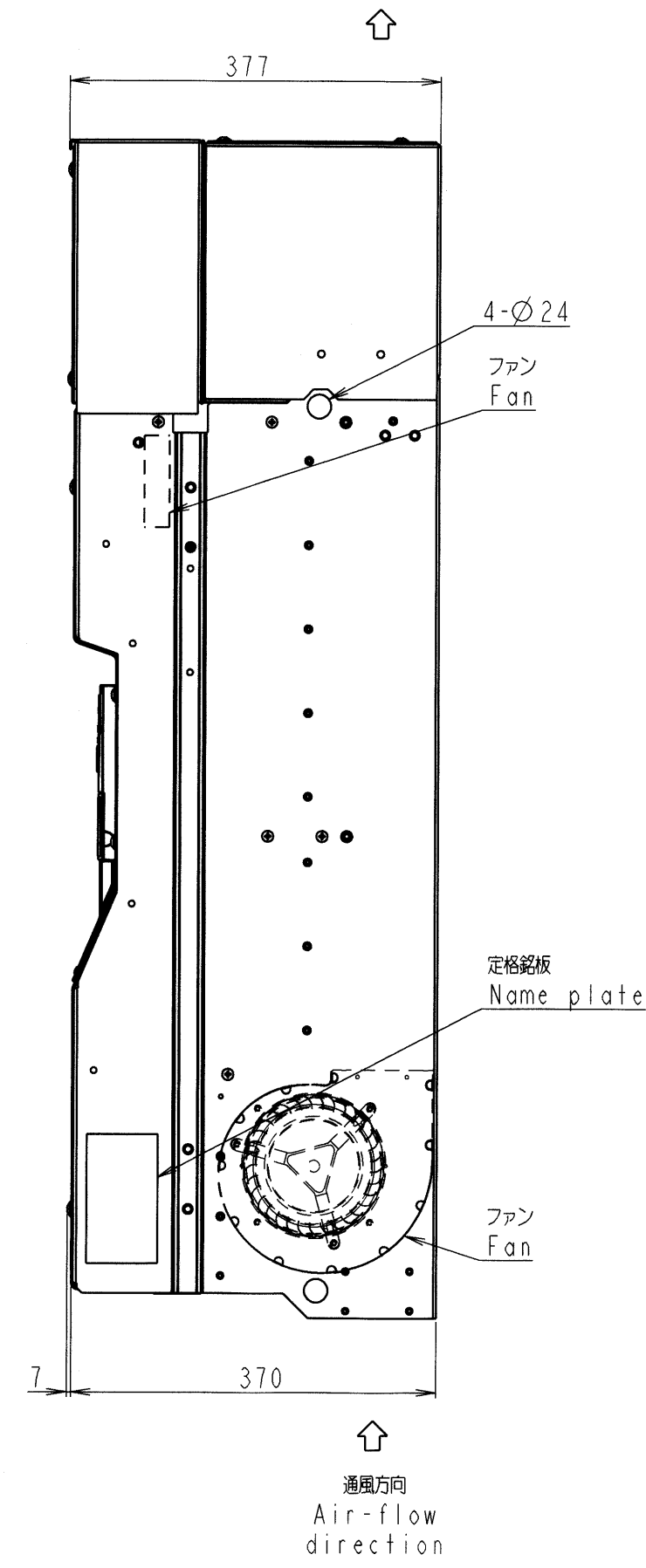

主回路端子台  
Main circuit terminal block  
入力/モーター端子台  
Input/Motor terminal block

ファン端子台 M4ネジ  
Fan terminal M4 screw (R0, S0, T0)

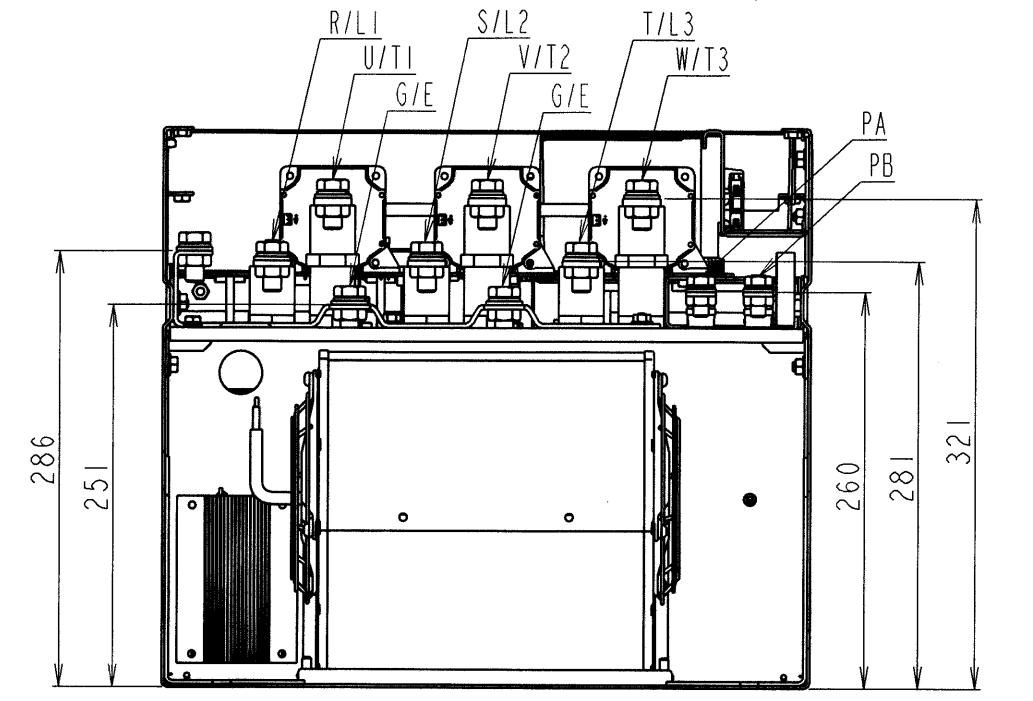
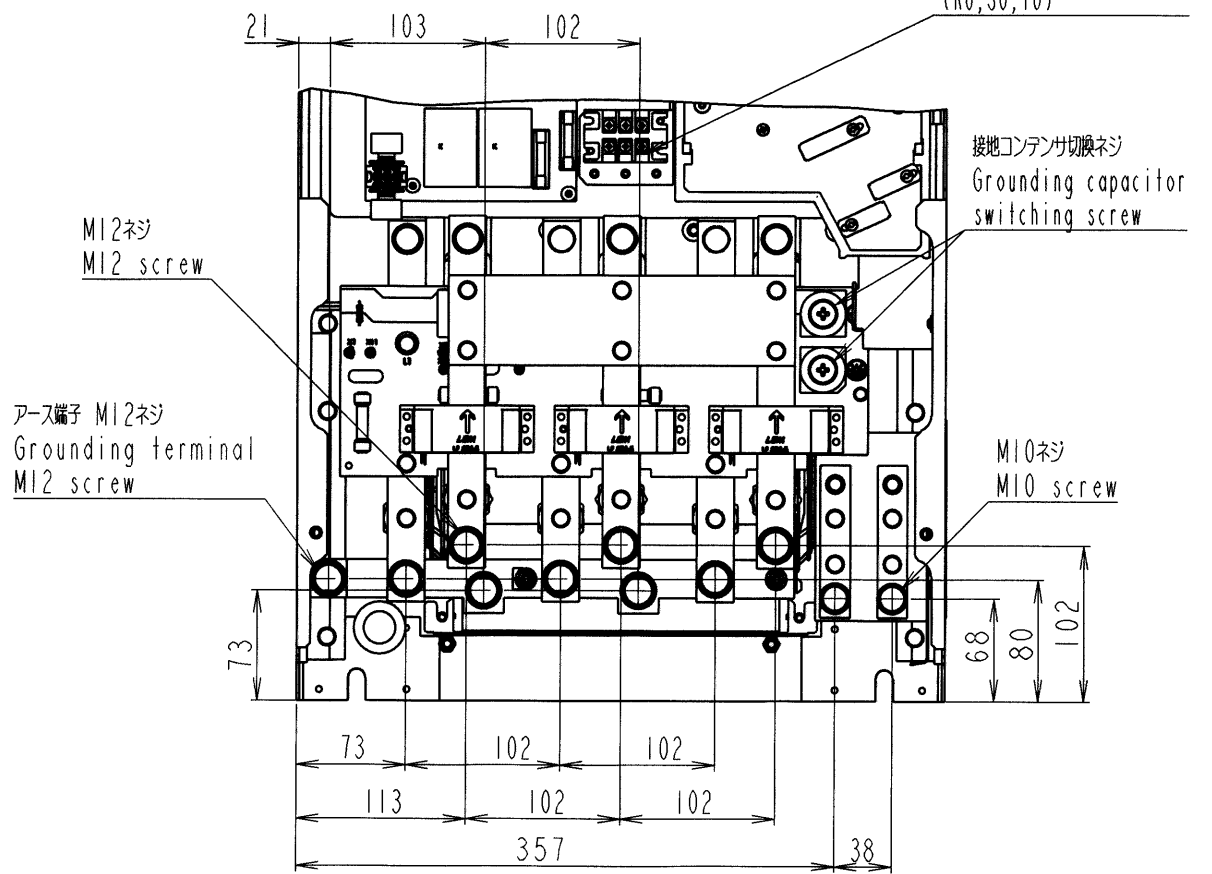

本体色:RAL7016 (Dark gray)  
JIS表示記号 10B 2.5/1  
Box color : RAL 7016 (Dark gray)  
JIS 10B 2.5/1

形式 TYPE-FORM	概略質量(kg) Approx. mass
VFAS1-4160KPC-W*1	161

INVERTER 器具名称 APPARATUS	VFAS1 形 TYPE	4160KPC-W*1 式 FORM
-------------------------------	--------------------	--------------------------

記号 MARK	承認 APPROVED BY	検図 CHECKED BY	名称 TITLE
年月日 DATE	14. Sep. '06	Y. Yamamoto	インバータ外形図 OUTLINE OF INVERTER
承認 APPROVED BY	設計 DESIGNED BY	製図 DRAWN BY	TOSVERT VF-ASI SERIES
変更者 REVISED BY	Y. Hatte	Y. Hatte	図面番号 DRAWING NO. P6582984
記事 CONTENTS	TOSHIBA 東芝シュネデール・インバータ株式会社 Toshiba Schneider Inverter Corporation		変更記号 REV. MARK
保管 REGISTERED	保管 REGISTERED		配布先 PRESENT TO