

図面番号 DRAWING NO.
P6582910

REV. MARK
②

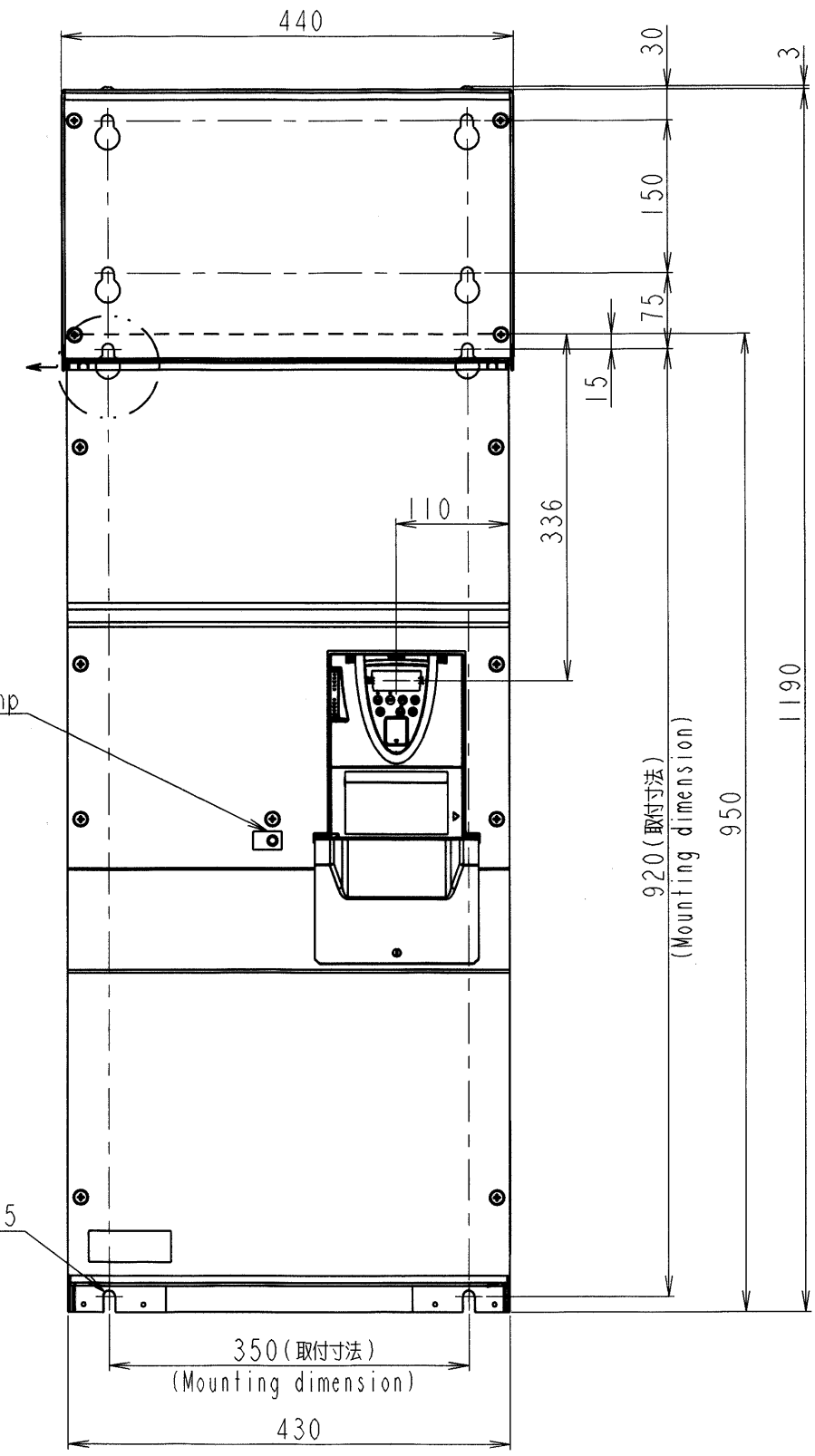
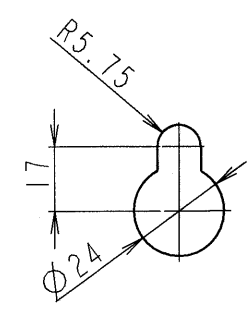

チャージランプ
Charge lamp

R5.75

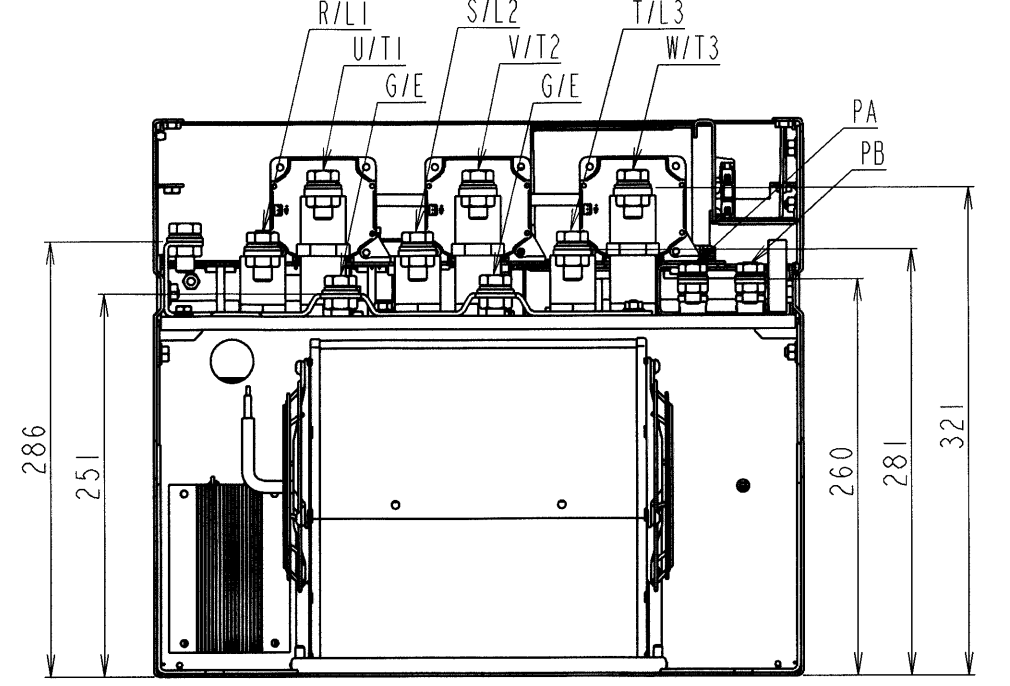
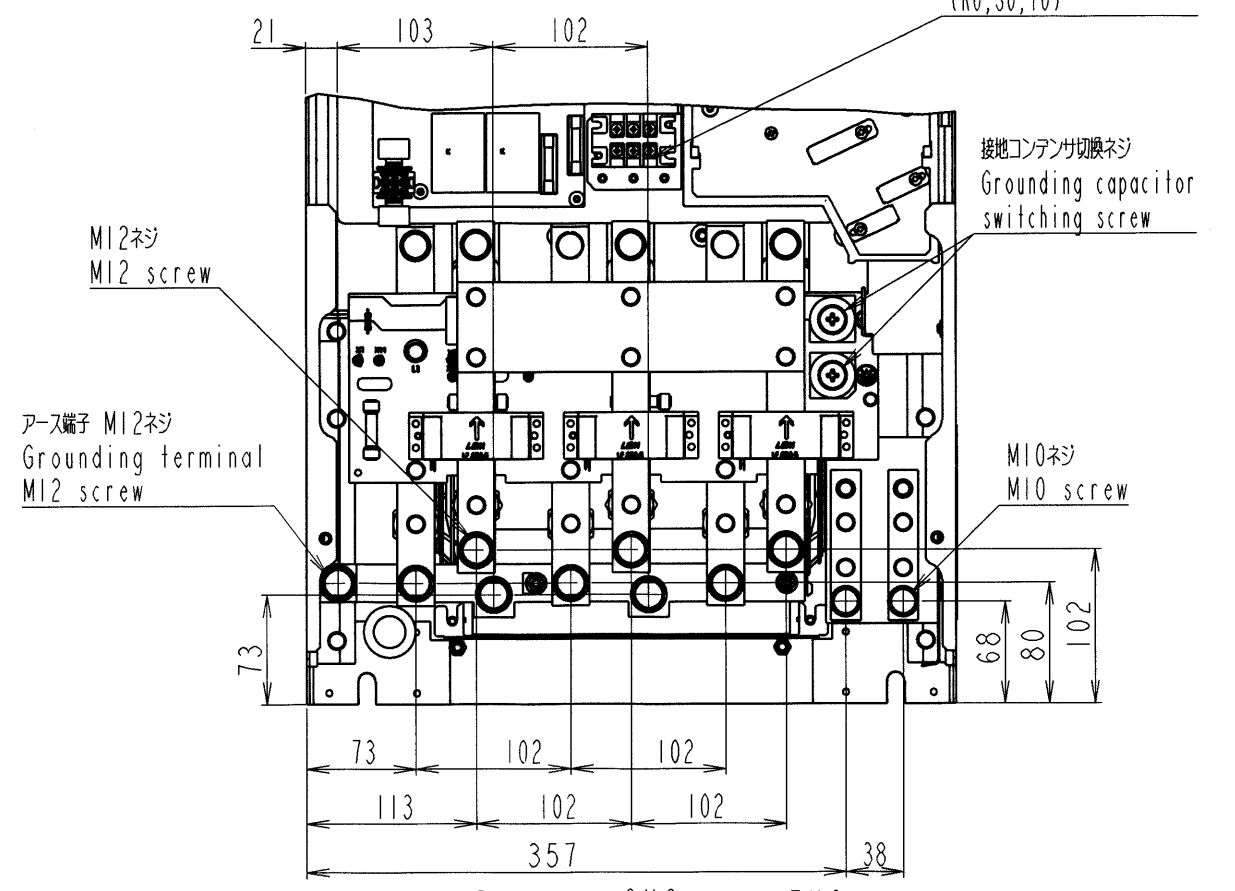
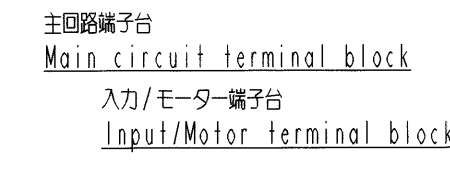
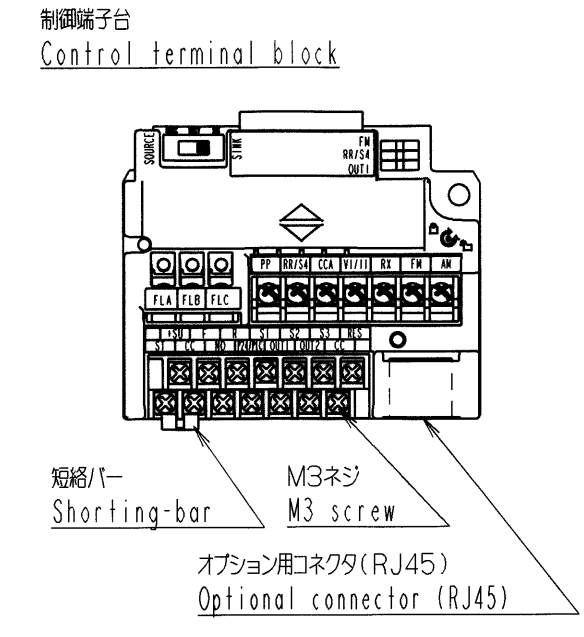
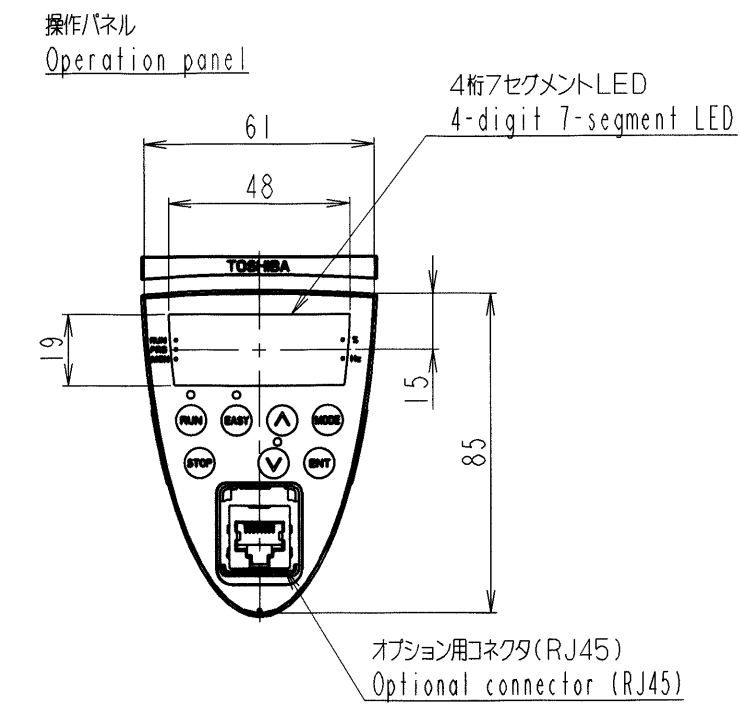
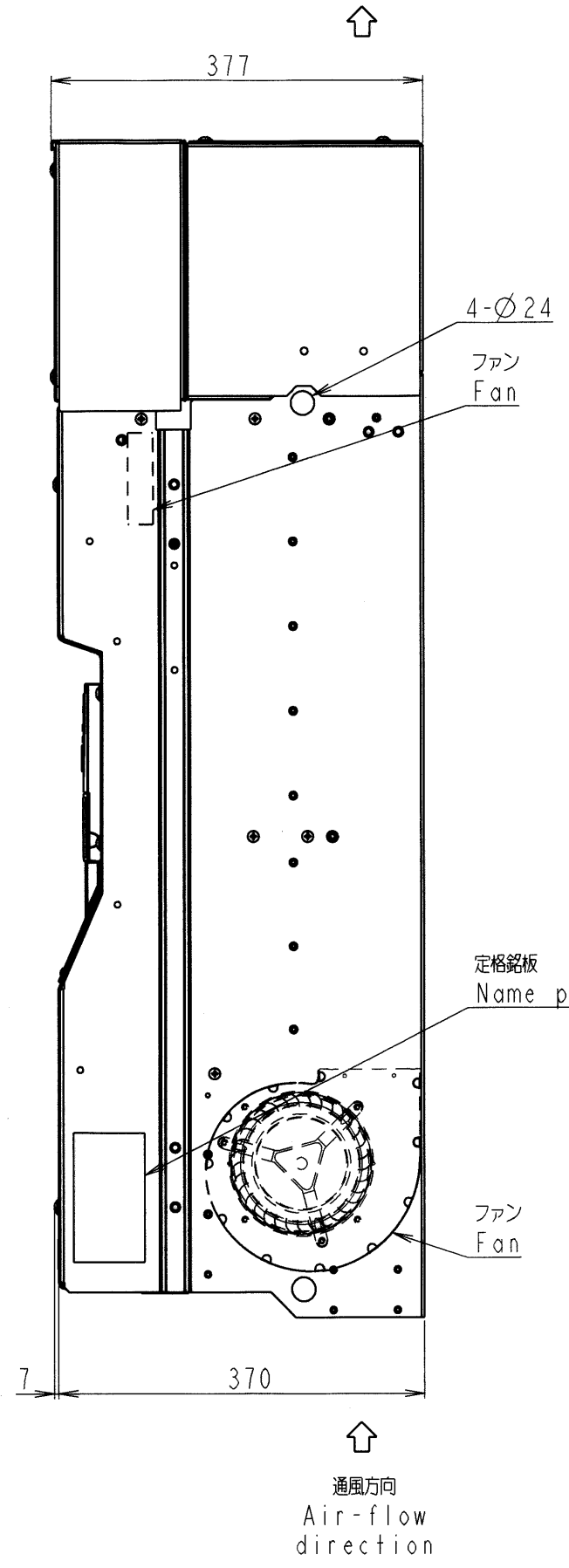
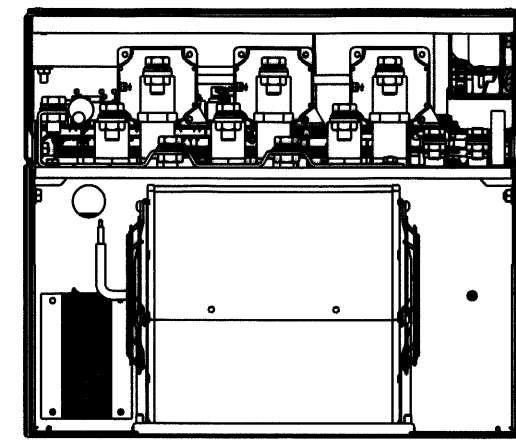

本体色: RAL7016 (Dark gray)
JIS表示記号 10B 2.5/1
Box color : RAL 7016 (Dark gray)
JIS 10B 2.5/1

形式 TYPE-FORM	概略質量(kg) Approx. mass
VFAS1-4160KPC-W*	161

INVERTER	VFAS1	4160KPC-W*
器具名称 APPARATUS	形 TYPE	式 FORM
承認 APPROVED BY H.Nishimura 14.Sep.'05	検図 CHECKED BY O.Yamamoto 14.Sep.'05	名称 TITLE インバータ外形図 OUTLINE OF INVERTER TOSVERT VF-ASI SERIES
設計 DESIGNED BY Y.Hotta 14.Sep.2005	製図 DRAWN BY Y.Hotta 14.Sep.2005	

	2	1	記号 MARK
	15.Sep.'06	21.Jun.'06	年月日 DATE
	S.Shirai	S.Shirai	承認 APPROVED BY
	Y.Hotta	Y.Hotta	変更者 REVISED BY
	DCL 形式削除 (訂正) Delete the type-form of DCL1.(Correction)	概略質量修正 Corrected the approx. mass.	記事 CONTENTS
			保管 REGISTERED

単位 UNITS
mm

TOSHIBA

東芝シュネーデルインバータ株式会社
Toshiba Schneider Inverter Corporation

図面番号 DRAWING NO.

P6582910

REV. MARK
②

保管 REGISTERED 05.9.15*

配布先 PRESENT TO