

図面番号 DRAWING NO. M6589845

変更記号 REV. MARK 3

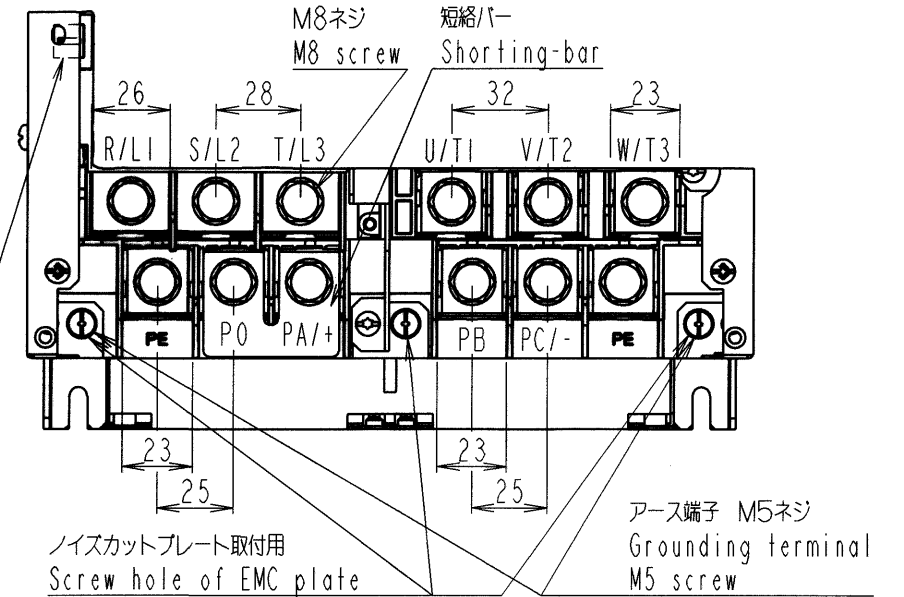
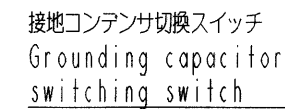
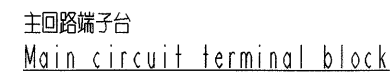
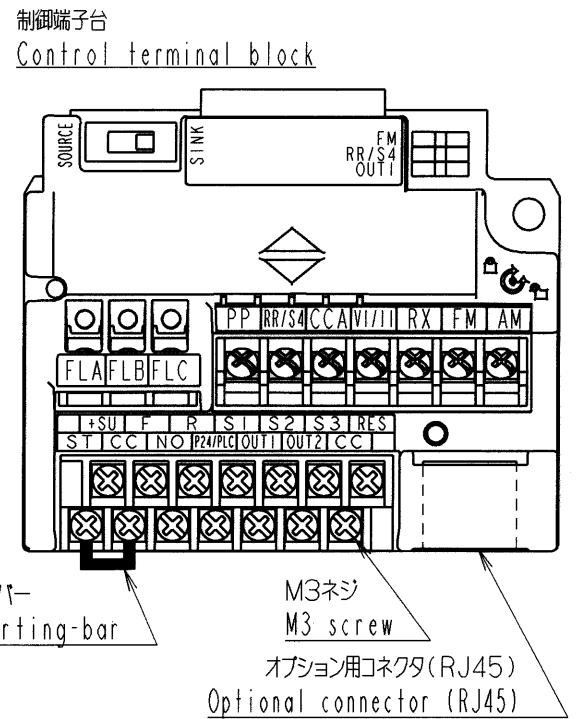
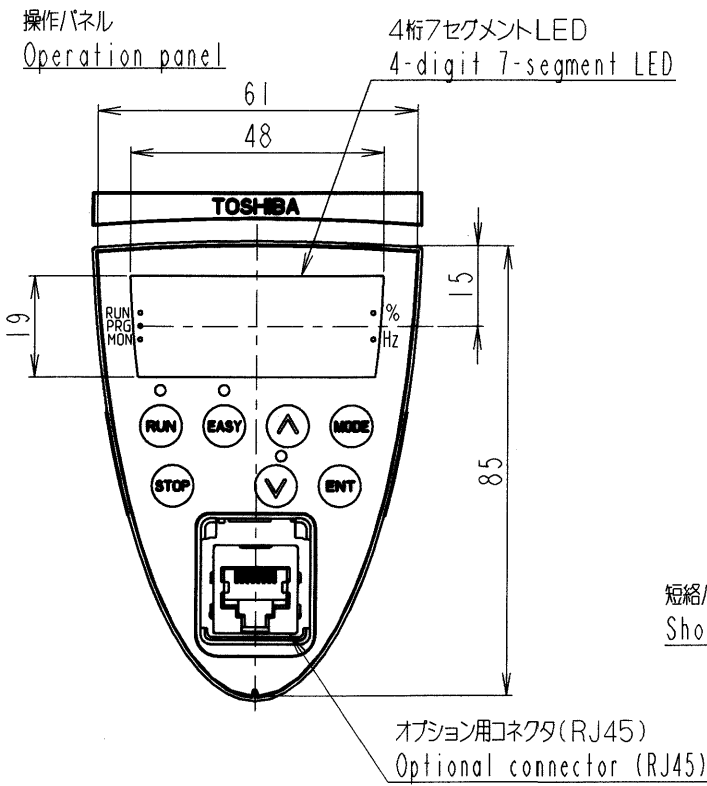
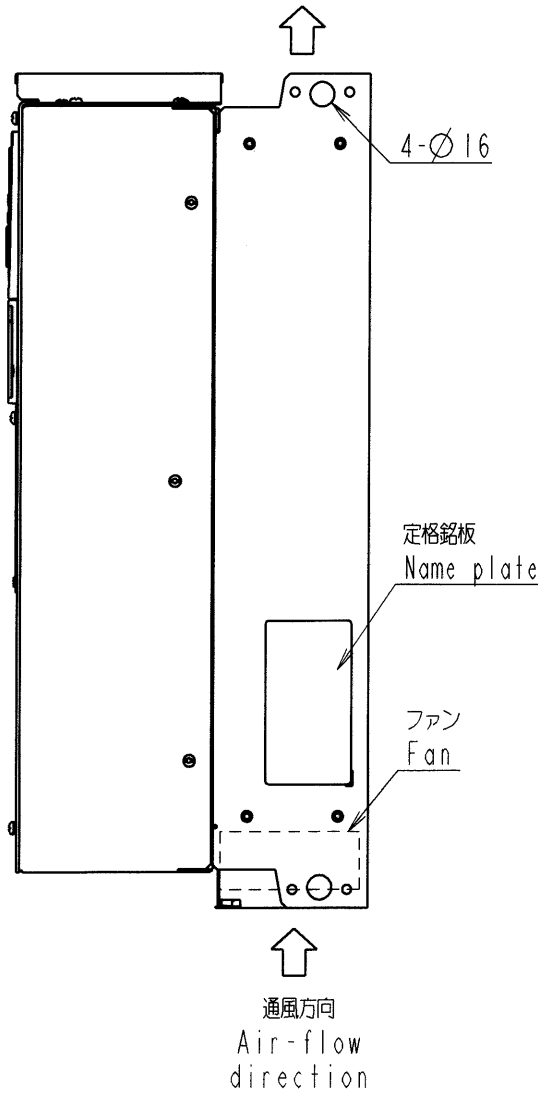
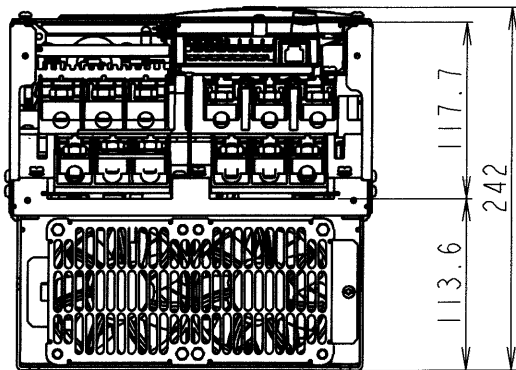
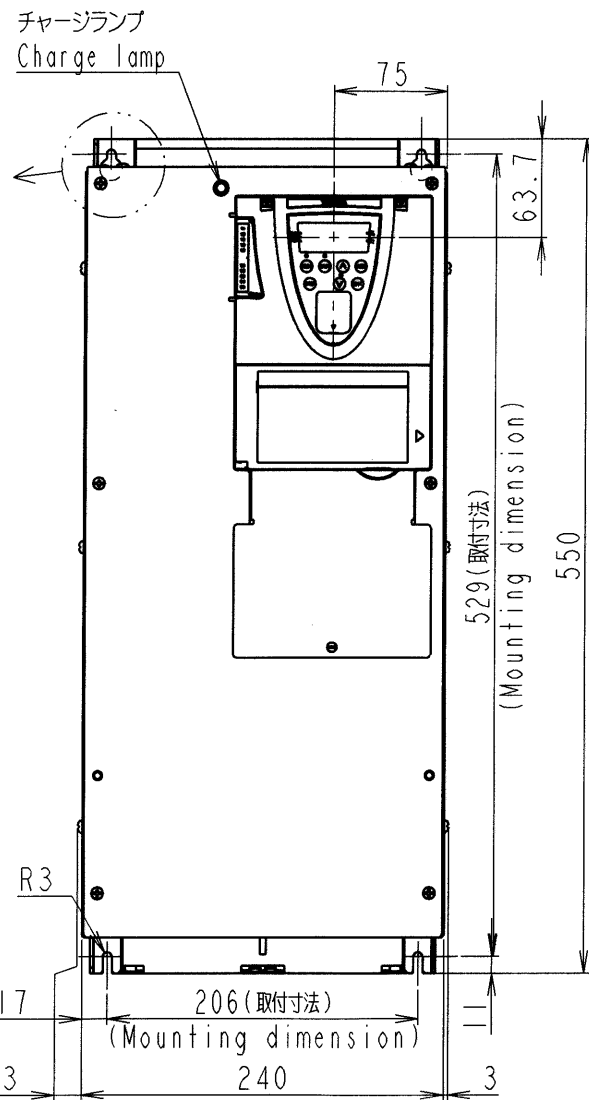

本体色:RAL7016(Dark grey)
JIS表示記号 10B 2.5/1
Box color:RAL7016(Dark grey)
JIS 10B 2.5/1

形式	概略質量(kg)
Inverter model	Approx. mass
VFASI-4300PL	29
VFASI-4370PL	29

INVERTER	VFASI	4300PL, 4370PL
器具名称	形	式
APPARATUS	TYPE	FORM
承認 APPROVED BY S. Shirai 13. May. '05	検図 CHECKED BY O. Yamamoto 13. May. '05	名称 TITLE
設計 DESIGNED BY M. Takeuchi 13. May. 2005	製図 DRAWN BY M. Takeuchi 13. May. 2005	インバータ外形図 OUTLINE OF INVERTER
TOSVERT VF-ASI SERIES		図面番号 DRAWING NO.
TOSHIBA 東芝シュネデール・インバータ株式会社 Toshiba Schneider Inverter Corporation		M6589845
保管 REGISTERED 05.5.16 *M		変更記号 REV. MARK 3

配布先 PRESENT TO ○○○○ 8