

図面番号 DRAWING NO.
M0720659

変更記号 REV. MARK

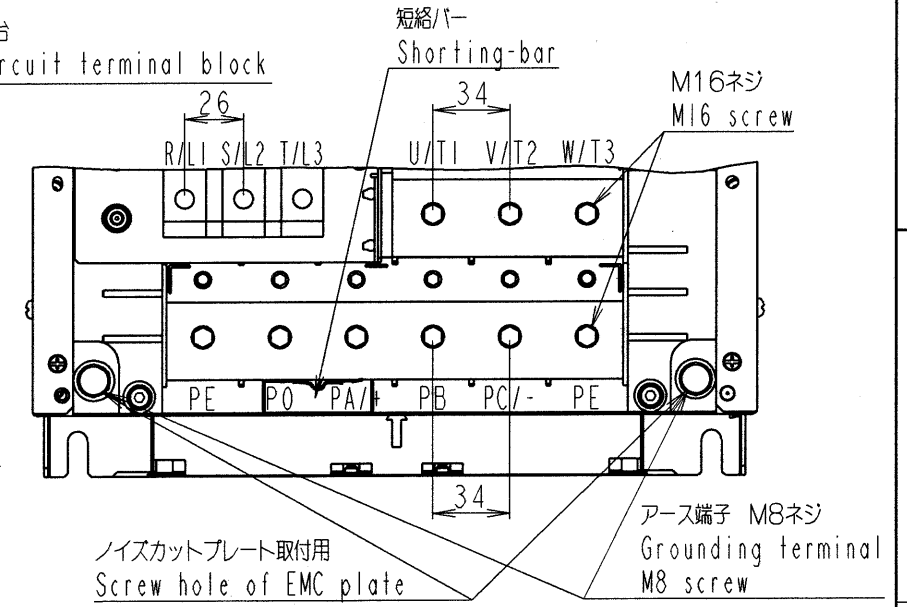
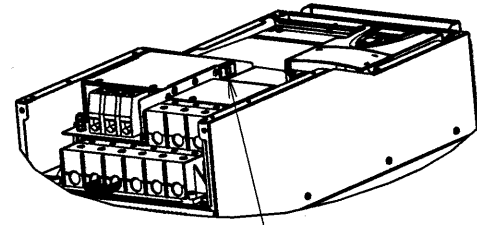
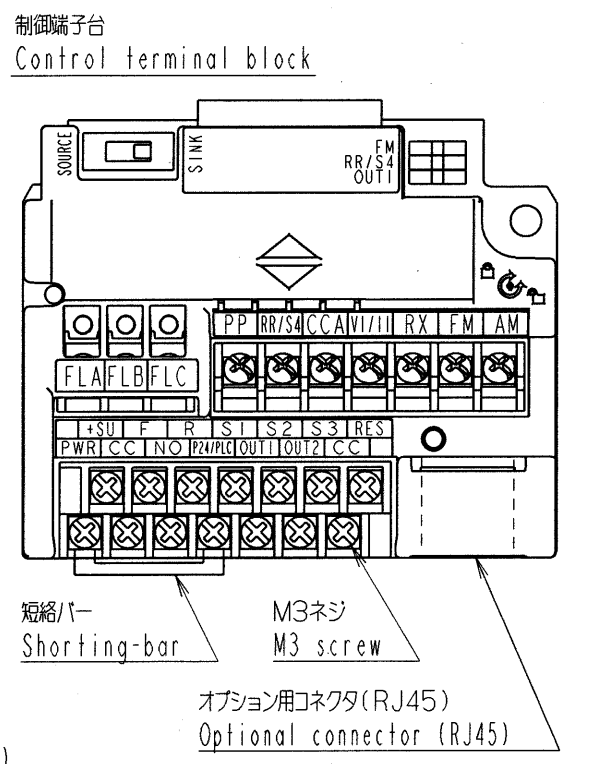
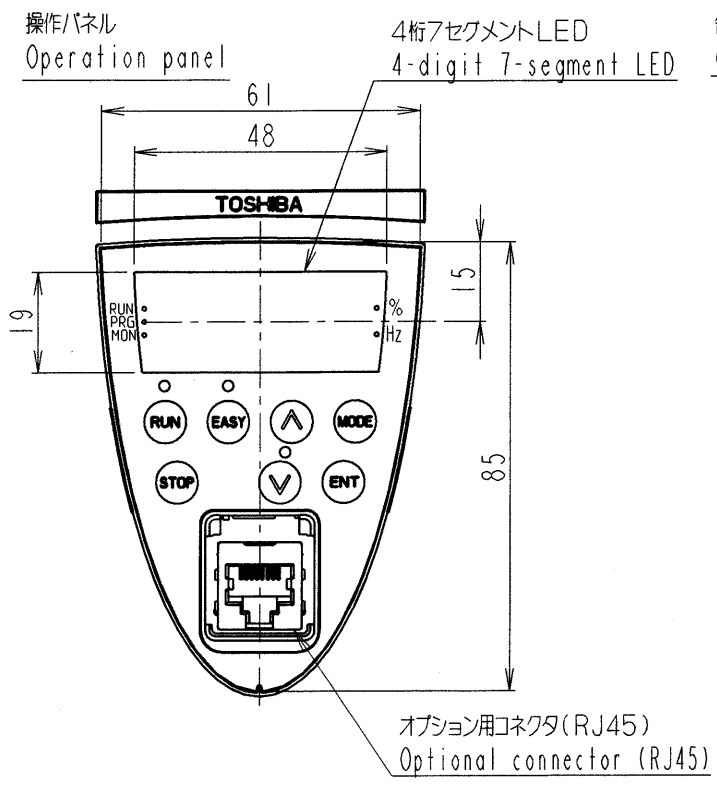
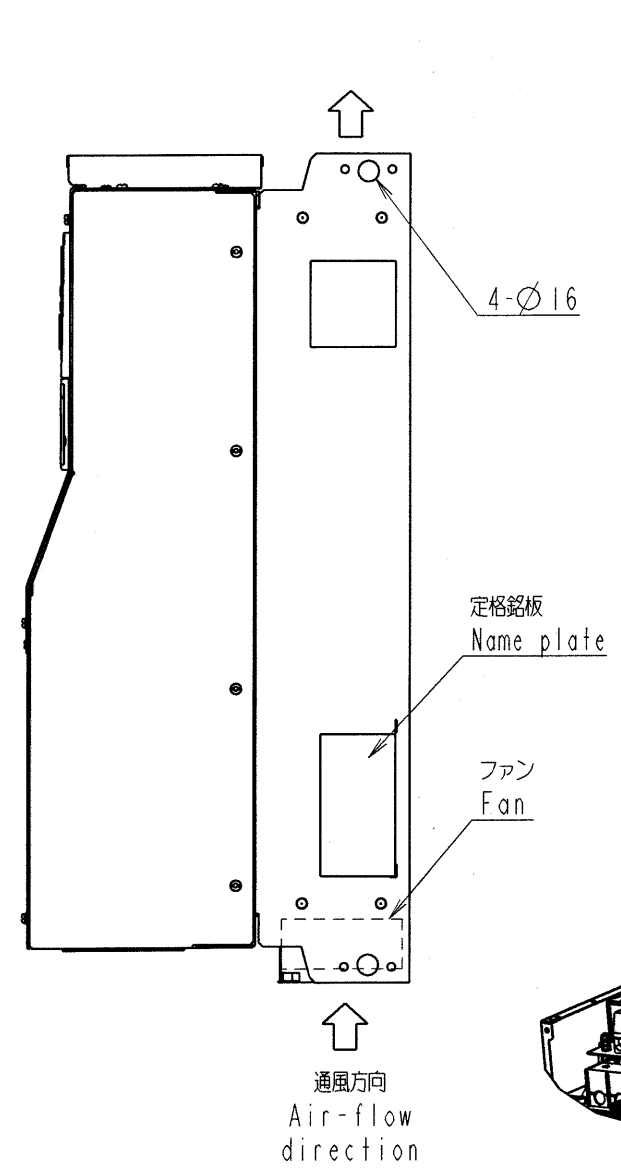
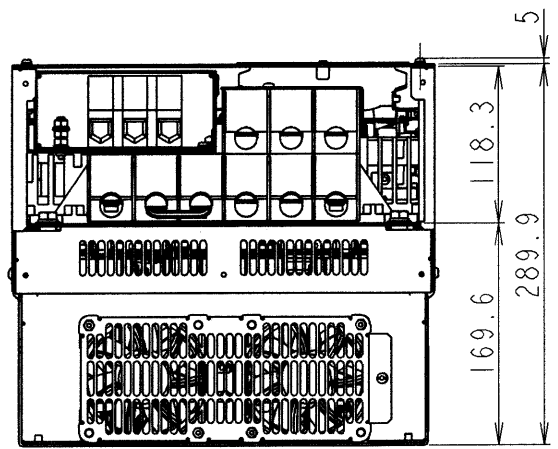
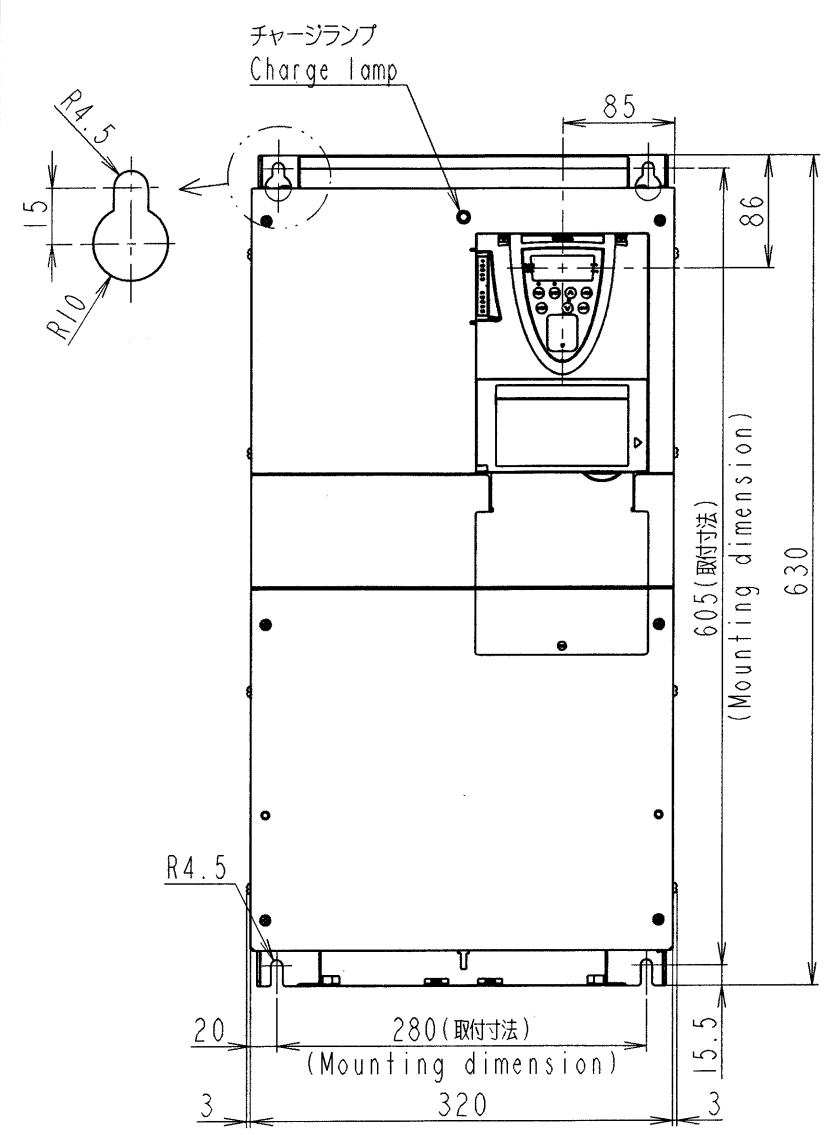
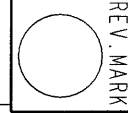

本体色:RAL7016(Dark grey)
JIS表示記号 10B 2.5/1
Box color:RAL7016(Dark grey)
JIS 10B 2.5/1

形式 Inverter model	概略質量(kg) Approx. mass
VFASI-6370PL	48
VFASI-6450PL	48
VFASI-6550PL	48
VFASI-6750PL	48
VFASI-6900PL	48

INVERTER	VFASI	6370PL, 6450PL, 6550PL, 6750PL, 6900PL
器具名称 APPARATUS	形 TYPE	式 FORM

記号 MARK	REVISIONS	承認 APPROVED BY <i>K. Furukashi</i> 15. Jul. 2008	検図 CHECKED BY <i>Y. Yamamoto</i> 15. Jul. '08	名称 TITLE インバータ外形図 OUTLINE OF INVERTER TOSVERT VF-ASI SERIES
年月日 DATE		設計 DESIGNED BY <i>M. Takeuchi</i> 14. Jul. '08	製図 DRAWN BY <i>Y. Ito</i> 3. Jul. '08	
承認 APPROVED BY		単位 UNITS mm		
変更者 REVISED BY		記事 CONTENTS		
保管 REGISTERED	変更 REGISTERED		図面番号 DRAWING NO. M0720659	

TOSHIBA 東芝シュネデール・インバータ株式会社
Toshiba Schneider Inverter Corporation

図面番号 DRAWING NO.
M0720659

変更記号 REV. MARK

保管 REGISTERED

配布先 PRESENT TO