

図面番号 DRAWING NO.
P6583029

REV. MARK

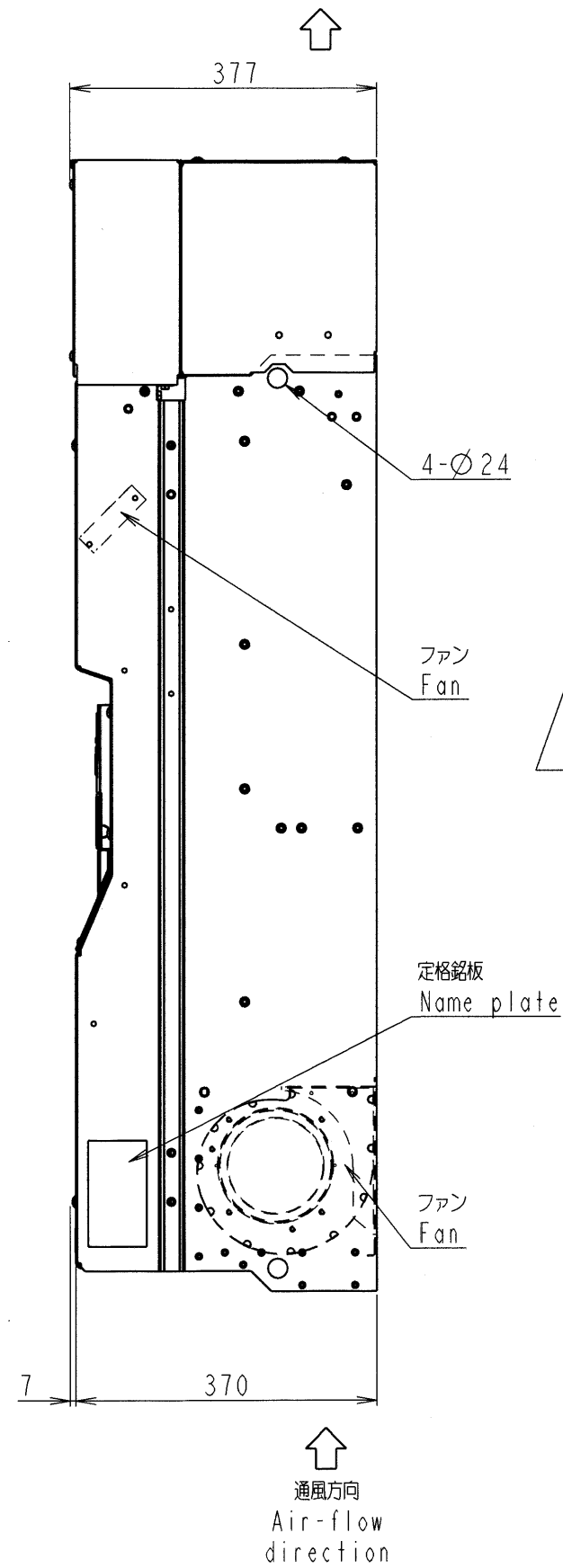

操作パネル
Operation panel

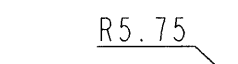
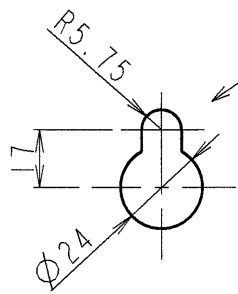
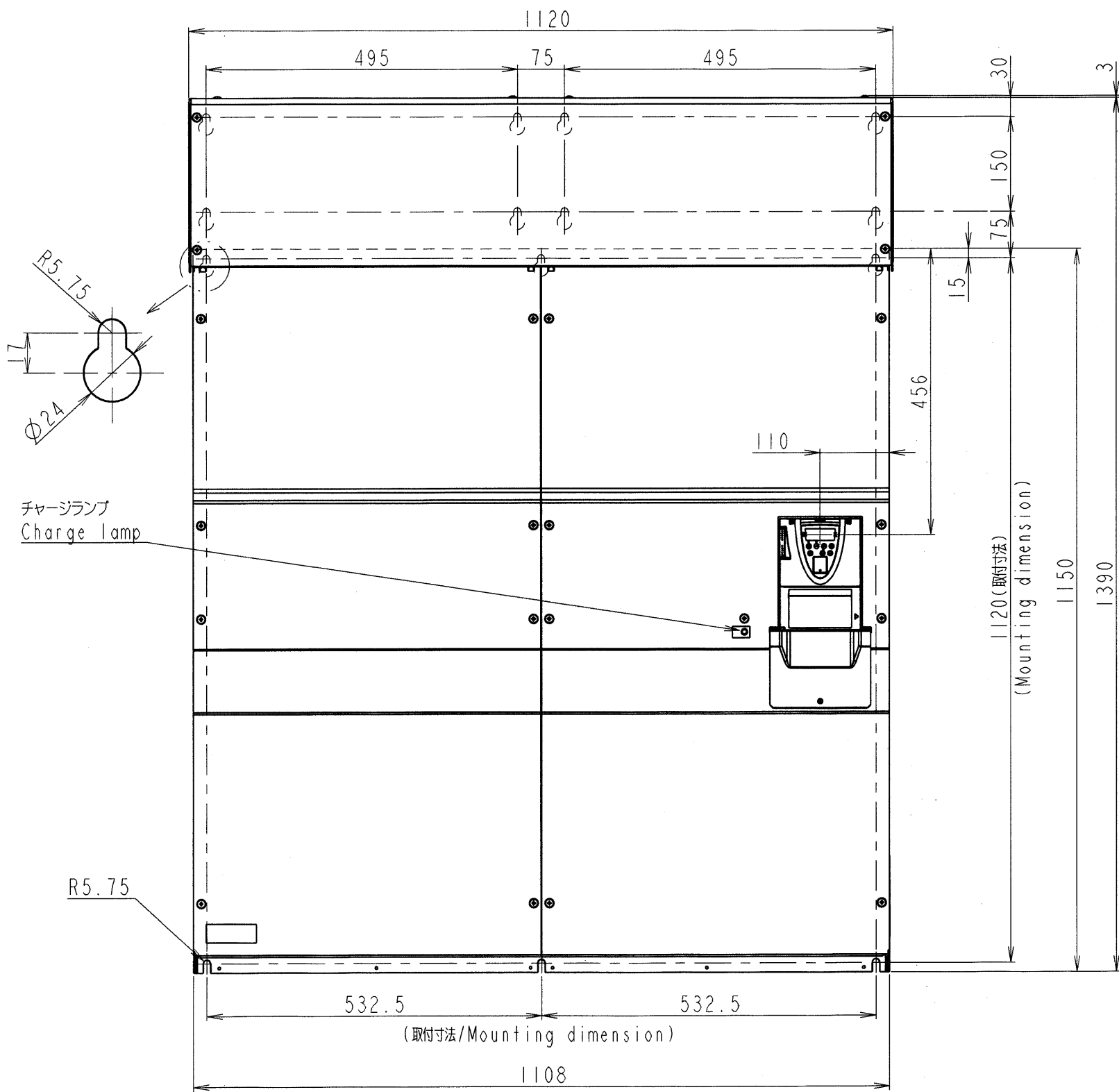
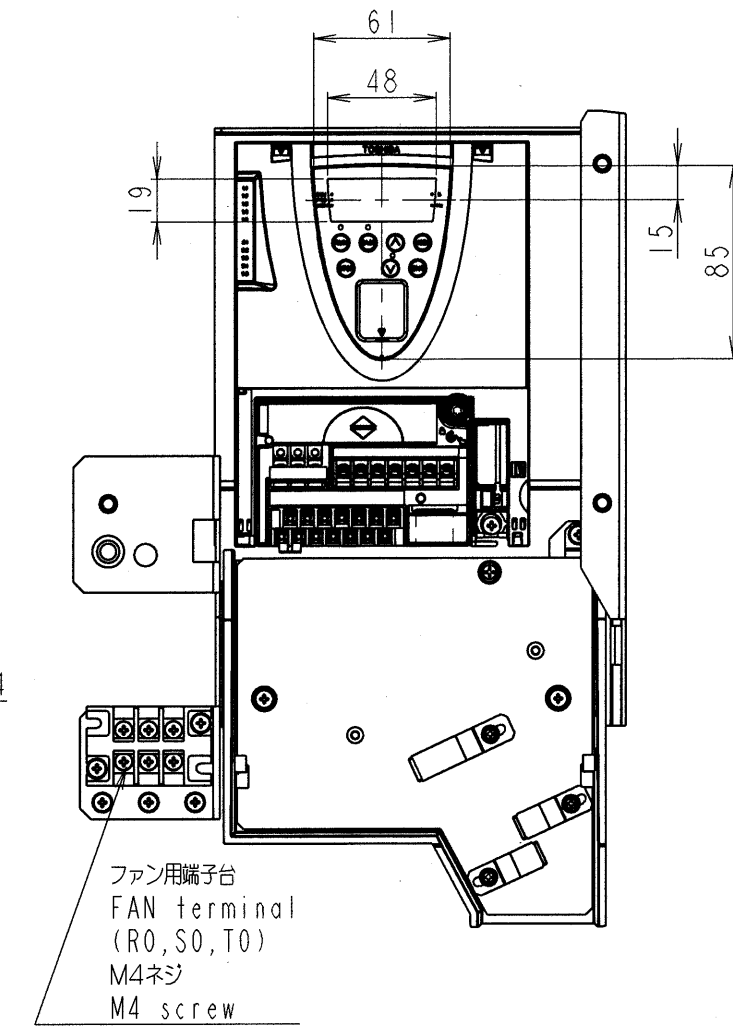

制御端子台
Control terminal block

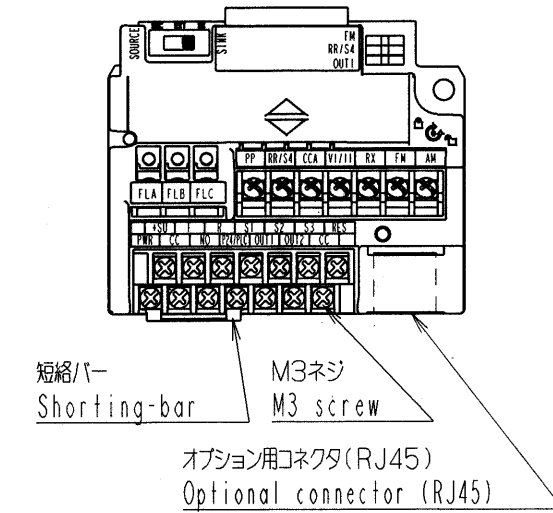

主回路端子台
Main circuit terminal block

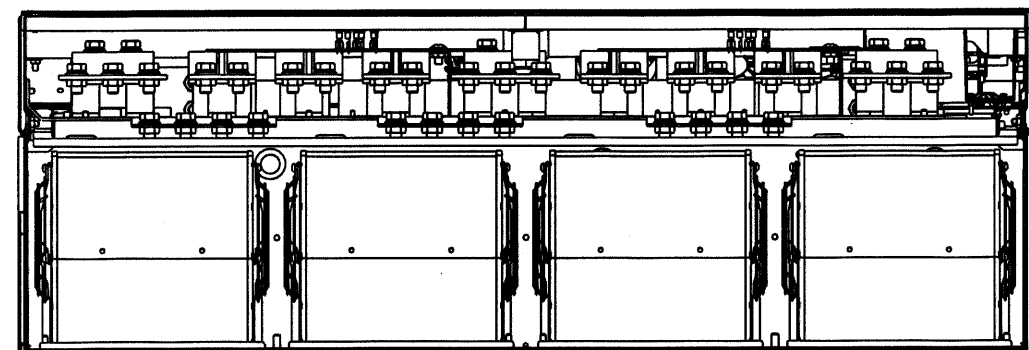
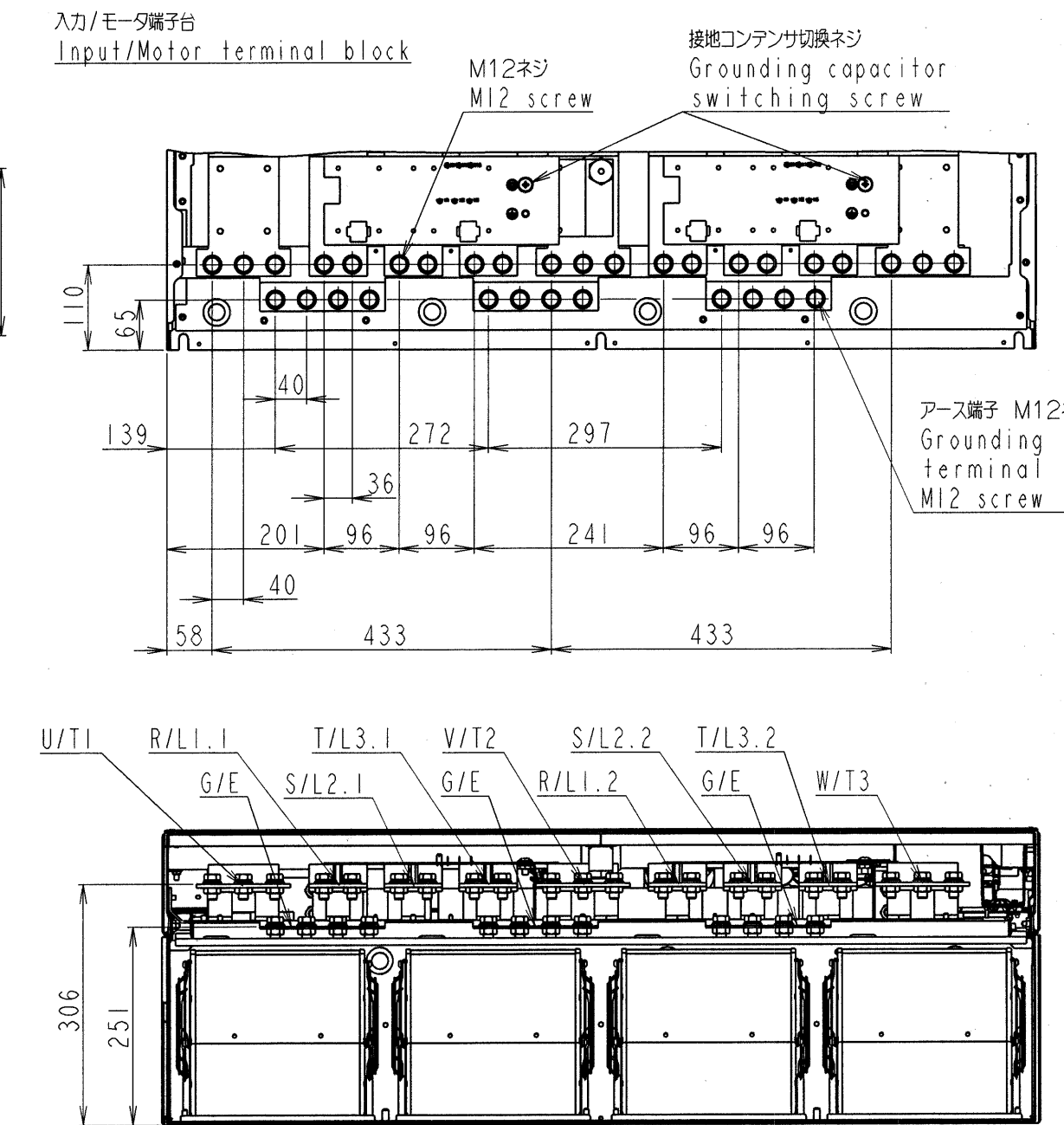

形式 TYPE-FORM	概略質量(kg) Approx. mass
VFASI-6400KPC	400
VFASI-6500KPC	400
VFASI-6630KPC	400

本体色:RAL7016(Dark gray)
JIS表示記号 10B 2.5/1
Box color:RAL7016(Dark gray)
JIS 10B 2.5/1

INVERTER	VFASI	6400KPC, 6500KPC, 6630KPC
----------	-------	---------------------------

器具名称 APPARATUS	形 TYPE	式 FORM
-------------------	-----------	-----------

承認 APPROVED BY <i>K. Furukashi</i> 13. Jul. 2008	検図 CHECKED BY <i>S. Yamamoto</i> 15. Jul. '08	名称 TITLE インバータ外形図 OUTLINE OF INVERTER TOSVERT VF-ASI SERIES
設計 DESIGNED BY <i>M. Takeuchi</i> 14. Jul. '08	製図 DRAWN BY <i>M. Takeuchi</i> 14. Jul. '08	

TOSHIBA

東芝シュネデールインバータ株式会社
Toshiba Schneider Inverter Corporation

図面番号 DRAWING NO.

P6583029

変更記号
REV. MARK

保管 REGISTERED

配布先

PRESENT TO