

TOSVERT VF-AS1

CC-Link Option Function Manual

CCL001Z

NOTICE

1. Make sure that this instruction manual is delivered to the end user of the CC-Link option for the VF-AS1.
2. Read this manual before installing or operating the CC-Link option for the VF-AS1. And keep it in a safe place for reference.

*The data given in this manual are subject to change without notice.

Introduction

Thank you for purchasing a "CC-Link Option (CCL001Z)" for TOSVERT VF-AS1 inverter.

This option can connect with open field network CC-Link and data communications with the CC-Link master through installing this option in the VF-AS1 and using it. Besides this instruction manual, the "CC-Link option Instruction Manual" is required to develop software communicating with VF-AS1. In such a case, please get in touch with our branch offices or sales offices. ("CC-Link Option Instruction Manual": E6581286).

This manual is also aimed at the operator using "VF-AS1 CC-Link option", so please use it for future maintenance and inspection.

- TOSVERT VF-AS1 Instruction Manual E6581301
- TOSVERT VF-AS1 CC-Link Option Instruction Manual E6581286

NOTICE

- ▼ See the instruction manual of "TOSVERT VF-AS1 CC-Link Option Instruction Manual" (E6581286) for cautions relating to the ambient environment, installation and wiring.
- ▼ Turn off the power supply when connecting or disconnecting a communication cable.
- ▼ When the control power is turn off by the instantaneous power failure, communication will be unavailable for a while.
- ▼ The Life of EEPROM is approximately ten thousand times. Avoid writing a command more than ten thousand times to the same parameter of the inverter.

— Table of contents —

1. Overview	3
2. Basic specifications	3
3. Name of functions of main parts	4
3.1. Set the station No. and baud rate	4
3.2. About indicator of LED	4
4. Functions	6
4.1. Initial setting	6
4.2. Inverter parameter (relate to the CC-Link)	7
4.3. Basic functions	8
4.3.1. Run and frequency operation command	8
4.3.2. Monitor	8
4.3.3. Writing and reading the parameter	8
4.4. Communication specification	9
4.4.1. Input/Output signal	10
4.4.2. Remote Register Assignment	13
4.4.3. Instruction Codes	15
4.4.4. The details of an error code	16
4.4.5. Description of reply code	17
4.4.6. Description of monitor code	18
4.4.7. Description of input terminal information	19
4.4.8. Description of output terminal information	19
5. Programming examples	20
5.1. Example of the inverter status reading	21
5.2. Example of the command mode setting	22
5.3. Example of the operation commands setting	23
5.4. Example of frequency command setting	23
5.5. Example of the output frequency monitoring	24
5.6. Example of the parameter writing	24
5.7. Example of the parameter reading	25
5.8. Example of the trip history reading	26
5.9. Example of the inverter resetting at inverter error	27
6. Unusual diagnosis	28
6.1. Option error	28
6.2. Disconnection error of network cable	28
6.3. How to check the error using the LEDs	29

1. Overview

This option allows the VF-AS1 inverter to be connected into a CC-Link network. CC-Link supports a maximum of 42 nodes, allowing for the Master unit and this option is based on CC-Link Ver.1.10.

The CCL001Z is able to operate RUN/STOP, monitor the status of the inverter, set the inverter's parameter and etc. by the CC-Link master through installing the VF-AS1. And it can use different applications.

2. Basic specifications

<Environmental specification>

Item	Specification
Operating environment	Indoors, an altitude of 3,000m or less, where the product will not be exposed to direct sunlight, corrosive or explosive gases, vapor, coarse particulates including dust, and where there is no grinding fluid or grinding oil nearby.
Ambient temperature	0 to +60°C
Storage temperature	-25 to +65°C
Related temperature	20 to 93% (no condensation and absence of vapor)
Vibration	5.9 m/s ² {0.6G} or less (10 – 55Hz)

<CC-Link communication specification>

Item	Specification
Number of units corrected	42 units max. (1 station occupied by 1 unit). May be used with other equipment. (*)
Baud rate	156k, 625k, 2.5M, 5M, 10Mbps
Power supply	5V DC supplied from the inverter
Station type	Remote device station
Number of stations occupied	One inverter occupies one station
Connect cable	CC-Link dedicated cable, CC-Link Ver1.10.compatible CC-Link dedicated cable
Maximum transmission distance	1200m (156kbps)

*Maximum number of units connected to one master station is 42 units (when only inverters are connected).

*If any other units are included, the number of occupied stations depends on the unit and therefore the following conditions must be satisfied:

$$1. \{(1 \times a) + (2 \times b) + (3 \times c) + (4 \times d)\} \leq 64$$

a : Number of units occupying 1 station c : Number of units occupying 3 stations

b : Number of units occupying 2 stations d : Number of units occupying 4 stations

$$2. \{(16 \times A) + (54 \times B) + (88 \times C)\} \leq 2304$$

A : Number of remote I/O stations ≤ 64

B : Number of remote device stations ≤ 42

C : Number of local, standby master
and intelligent device stations ≤ 26

3. Name of functions of main parts

■ Layout of LED

3.1. Set the station No. and baud rate

For the setting station number or communication speed to take effect, power needs to be turned off and then turned back on.

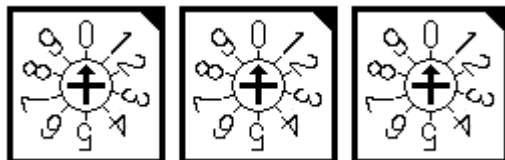

x10

x1

BAUD RATE

1. Set the Station No.

Set the inverter station number before switching on the inverter and do not change the setting while power is on.

The station number can be set between 1 and 64.

The switch x10 is set up the ten's place and x1 is set up the ones.

Set the arrow (↑) of the corresponding switch to the required numeral.

*The station number changed while powering on the inverter is not made valid.

*Set the station numbers consecutively in a connection sequence.

(The station numbers may be also set independently of the connection sequence.)

*Note that the same station number cannot be regarded.

(If the same station number is repeated, proper communication cannot be made.)

*Set each station number switch to the position of its numeral securely. If it set to any position between numerals, normal data communication cannot be made.

2. Setting the communication speed

SW	0	1	2	3	4
Baud rate	156kbps	625bps	2.5Mbps	5Mbps	10Mbps

*It causes an error when the switches are not set correct position (ex. set position between 0 and 1 switch label), or set over 5.

Set the communication baud rate switch same as the master unit.

3.2. About indicator of LED

The LED shows the present status of the network and error.

※Refer to this manual [6.3. How to check the error using the LEDs].

C C L i n k	POWER	Light on during power on.
	L.RUN	Light on during communication.
	SD	Light on during send the data of CC-Link.
	RD	Light on during receive the data of CC-Link.
	L.ERR	Light on during communication error.

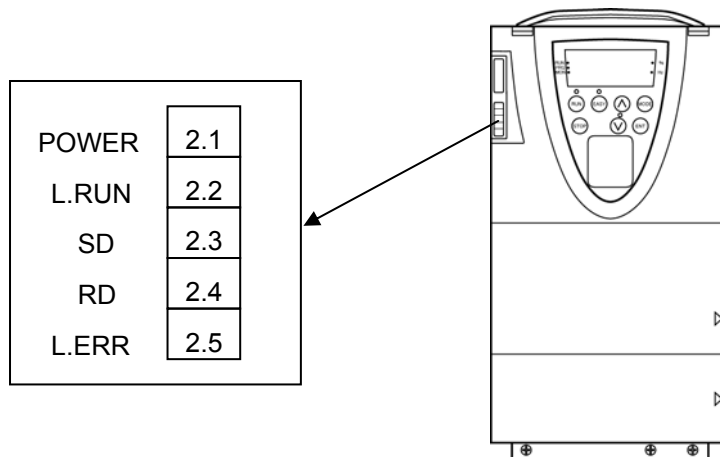

Behavior of LED

Status of LED				Cause
L.RUN	SD	RD	L.ERR	
●	◎	◎	◎	Normal communication is made but CRC error has occurred due to noise.
●	◎	◎	○	Normal communication
●	◎	○	◎	Hardware fault
●	◎	○	○	Hardware fault
●	○	◎	◎	Cannot answer due to CRC error of receive data.
●	○	◎	○	Data sent to the host station does not reach destination.
●	○	○	◎	Hardware fault
●	○	○	○	Hardware fault
○	◎	◎	◎	Polling response is made but refresh receive is in CRC error.
○	◎	◎	○	Hardware fault
○	◎	○	◎	Hardware fault
○	◎	○	○	Hardware fault
○	○	◎	◎	Data sent to the host station is in CRC error.
○	○	◎	○	There is no data sent to the host station, or data sent to the host station cannot be received due to noise.
○	○	○	◎	Hardware fault
○	○	○	○	Cannot receive data due to break in the cable, etc.
○	○	◎ or ○	●	Invalid baudrate or station number setting.
●	◎	◎	◎	Baud rate or station number is changed during operation.
○	○	○	○	WDT error occurrence (hardware fault), power off or supply failure.

● : On ○ : Off ◎ : Flicker

4. Functions

This option is a communication interface unit that allows the PLC program to operate, monitor and set the parameter of the inverter as a remote station of CC-Link. It is able to communicate with a maximum speed of 10Mbps not only transmitting bit data but also by word data.

4.1. Initial setting

Set the following parameters of the inverter.

Name of parameter	functions	Description	Factory setting	CC-Link setting
<i>F00d</i>	Command mode selection	<i>0</i> : Terminal input enabled <i>1</i> : Operation panel input enabled (including LED/LCD option unit) <i>2</i> : 2-wire RS485 communication input <i>3</i> : 4-wire RS485 communication input <i>4</i> : Communication option input	<i>0</i>	<i>4</i>
<i>F00d</i>	Frequency setting mode selection 1	<i>1</i> : VI/II (voltage/current input) <i>2</i> : RR/S4 (potentiometer/voltage input) <i>3</i> : RX (voltage input) <i>4</i> : Operation panel input enabled (including LED/LCD option input) <i>5</i> : 2-wire RS485 communication input <i>6</i> : 4-wire RS485 communication input <i>7</i> : Communication option input <i>8</i> : Optional AI1 (differential current input) <i>9</i> : Optional AI2 (voltage/current input) <i>10</i> : Up/Down frequency <i>11</i> : Optional RP pulse input <i>12</i> : Optional high-speed pulse input <i>13</i> : Optional binary/BCD input	<i>2</i>	<i>7</i>
<i>F420</i>	Torque command selection	<i>1</i> : VI/II (voltage/current input) <i>2</i> : RR/S4 (potentiometer/voltage input) <i>3</i> : RX (voltage input) <i>4</i> : Operation panel input enabled (including LED/LCD option input) <i>5</i> : 2-wire RS485 communication input <i>6</i> : 4-wire RS485 communication input <i>7</i> : Communications option input enabled <i>8</i> : Optional AI1 (differential current input)	<i>3</i>	*

*Change the setting of F420 if necessary.

4.2. Inverter parameter (relate to the CC-Link)

Title	Function	Description
<i>F850</i>	Disconnection detection extended time	<i>0.0</i> to <i>100.0</i> sec.
<i>F851</i>	Inverter operation at disconnection	<i>0</i> : Stop and Communication release (by <i>CNOd</i> , <i>FNOd</i>) <i>1</i> : None (continued operation) <i>2</i> : Deceleration stop <i>3</i> : Coast stop <i>4</i> : Network error(<i>ErrB</i> trip) <i>5</i> : Preset speed operation (by <i>F852</i> setting)
<i>F852</i>	Preset speed operation selection	<i>0</i> : None <i>1</i> to <i>15</i> : Preset speed operation (by parameter setting)
<i>F853</i>	Communication option station address monitor (Read only)	Station No. <i>1</i> to <i>64</i> (case by CC-Link option)
<i>F854</i>	Communication option speed switch monitor (Read only)	<i>0</i> : 156kbps <i>1</i> : 625kbps <i>2</i> : 2.5Mbps <i>3</i> : 5Mbps <i>4</i> : 10Mbps
<i>F899</i>	Network option reset setting	<i>0</i> : None <i>1</i> : Reset option circuit board and inverter

■Version check of option card CPU

The version of the option with it has equipped can be checked by using the function of *F710* to *F718* (standard monitor display selection).

*For details, refer to Instruction Manual E6581301.

Title	Function	Setting	Description
<i>F710</i>	Standard display monitor	<i>32</i>	Add-on option 1 CPU version (Under side option)
<i>F718</i>		<i>33</i>	Add-on option 2 CPU version (Panel side)

For example, a panel display shown 1.02, when a CPU version is 1 (01H) and revision is 2 (02H).

4.3. Basic functions

This clause shows the basic function of this CC-Link option using by CC-Link communication.

4.3.1. Run and frequency operation command

The PLC program can operate the inverter to run, stop, set the operation frequency and change the parameters.

If the PLC control these operations, select the command mode and the frequency setting mode. (Change the setting of the torque command selection if necessary.)

The parameter setting of the inverter

Command mode selection

C70d : 4[Communication option input] (Factory setting: 0)

Frequency setting mode selection

F70d : 7[Communication option input] (Factory setting: 2)

Torque command selection

F420 : 7[Communication option input] (Factory setting: 3)

*The frequency setting and command can be made CC-Link priority by RYnA and RYnB.

*"n" is depend on the station number.

4.3.2. Monitor

It is able to monitor the status of the inverter.

Set a monitor code to RWwn and turn RYnC on. The data is stored in the buffer memory of the PLC.

*"n" is depend on the station number.

- Refer to "Section 4.4.6. Description of monitor code" about the monitor code and unit.

4.3.3. Writing and reading the parameter

The PLC can read, write the inverter parameters and reset the inverter.

Set the command code to RWw(n+2) (set the write data to RWw(n+3) if necessary) and turn RYnF (instruction code execution request) on. The inverter performs processing corresponding to the command code, return the response data, read out data and RXnF (instruction code execution completion).

- Refer to "Section 4.4. Communication specification" about the command code, the unit of the data, and the setting range.

4.4. Communication specification

This option occupies one station area of the buffer memory of the PLC.

There are remote I/O (RX, RY both 32 bits) and the remote register (RWw, RWr both 4 word) in the communication data for one station area.

List of remote I/O

Inverter (Slave) → PLC (Master)		PLC (Master) → Inverter (Slave)	
Device No.	Signal	Device No.	Signal
RXn0	Forward running	RYn0	Forward rotation command
RXn1	Reverse running	RYn1	Reverse rotation command
RXn2	Output terminal 1 (OUT1)	RYn2	Input terminal 5 (S1)
RXn3	Output terminal 2 (OUT2)	RYn3	Input terminal 6 (S2)
RXn4	Output terminal 3 (FL)	RYn4	Input terminal 7 (S3)
RXn5	Output terminal 4 (OUT3)	RYn5	Input terminal 8 (S4)
RXn6	Output terminal 5 (OUT4)	RYn6	Input terminal 9 (L1)
RXn7	Output terminal 6 (R1)	RYn7	Input terminal 10 (L2)
RXn8	Output terminal 7 (OUT5)	RYn8	Input terminal 11 (L3)
RXn9	Output terminal 8 (OUT6)	RYn9	Intercept output to inverter (Coast stop)
RXnA	Output terminal 9 (R2)	RYnA	Frequency priority CC-Link
RXnB	Reserved	RYnB	Command priority CC-Link
RXnC	Monitoring	RYnC	Monitor command
RXnD	Frequency setting completion (RAM)	RYnD	Frequency setting command (RAM)
RXnE	Torque setting completion (RAM)	RYnE	Torque setting command (RAM)
RXnF	Instruction code execution completion	RYnF	Instruction code execution request
RX(n+1)0	Reserved	RY(n+1)0	Reserved
RX(n+1)1		RY(n+1)1	
RX(n+1)2		RY(n+1)2	
RX(n+1)3		RY(n+1)3	
RX(n+1)4		RY(n+1)4	
RX(n+1)5		RY(n+1)5	
RX(n+1)6		RY(n+1)6	
RX(n+1)7		RY(n+1)7	
RX(n+1)8	Reserved	RY(n+1)8	Reserved
RX(n+1)9	Reserved	RY(n+1)9	Reserved
RX(n+1)A	Error status flag	RY(n+1)A	Error reset request flag (A reset request is during switched ON)
RX(n+1)B	Remote station ready	RY(n+1)B	Reserved
RX(n+1)C	Reserved	RY(n+1)C	Reserved
RX(n+1)D		RY(n+1)D	
RX(n+1)E		RY(n+1)E	
RX(n+1)F		RY(n+1)F	

"n" is depend on the station number.

The reserved input signal should be set OFF ("0").

RWr, RWw (Default value = 0)

Inverter → PLC		PLC → Inverter	
RWr	Contents	RWw	Contents
RWr n	First monitor value	RWw n	Monitor code (first and second)
RWr n+1	Second monitor value (output frequency)	RWw n+1	Set frequency/ torque
RWr n+2	Reply code	RWw n+2	Instruction code
RWr n+3	Read data	RWw n+3	Write data

"n" is depend on the station number.

4.4.1. Input/Output signal

*The default value is 0(zero) of RY and RX.

(1) Output signal Master unit -> Inverter

The output signal from the master unit is shown. (The input signal to the inverter.)

Device No.	Signal	Description	
RYn0	Forward run command	OFF: Stop command	ON: Forward run command
RYn1	Reverse run command	OFF: Stop command	ON: Reverse run command
RYn2	Input terminal selection5(S1)	The function depends on input terminal selection 5(F 115). *2	
RYn3	Input terminal selection6(S2)	The function depends on input terminal selection 6(F 116). *2	
RYn4	Input terminal selection7(S3)	The function depends on input terminal selection 7(F 117). *2	
RYn5	Input terminal selection8(S4)	The function depends on input terminal selection 8(F 118). *2	
RYn6	Input terminal selection9(L1)	The function depends on input terminal selection 9(F 119). *2	
RYn7	Input terminal selection10(L2)	The function depends on input terminal selection 10(F 120). *2	
RYn8	Input terminal selection11(L3)	The function depends on input terminal selection 11(F 121). *2	
RYn9	Intercept output to inverter (Coast stop)	Stop the output of the inverter when turned on this signal. (Stop the output in the secondary circuit)	
RYnA	Frequency priority CC-Link	Signals from the CC-Link are used to start and stop operation.	
RYnB	Command priority CC-Link	Speed commands are entered from the CC-Link.	
RYnC	Monitor command	When the monitor command (RYnC) is switched on, the monitored value is set to remote register RWrn and monitoring (RXnC) switches on. While the monitor command (RYnC) is on, the monitored value is always update.	
RYnD	Frequency setting command (RAM)	When the frequency setting command (RYnD) is switched on, the set frequency RWwn+1 is written to the inverter. On completion of write, frequency setting completion (RXnD) switches on.	
RYnE	Torque setting command (RAM)	When the torque setting command (RYnE) is switched on, the set torque RWwn+1 is written to the inverter. On completion of write, torque setting completion (RXnE) switches on.	
RYnF	Instruction code execution request	When the instruction code execution request (RYnF) is switched on, processing corresponding to the instruction code set to RWwn+2 is executed. After completion of instruction code execution, instruction code execution completion (RYnF) switches on. When an instruction code execution error occurs, a value other than 0 is set to the reply code (RWrn+2).	
RY(n+1)0 :	Reserved	Reserved for the system. *3	
RY(n+1)7			
RY(n+1)8			
RY(n+1)9	Reserved	Reserved for the system. *3	
RY(n+1)A	Error reset request flag *2	If the error reset request flag (RY(n+1)A) is switched on only when an inverter fault occurs, the inverter is reset and the error status flag (RX(n+1)A) switches off. A reset request is during switched ON.	
RY(n+1)B	Reserved	Reserved for the system. *3	
RY(n+1)C :	Reserved	Reserved for the system. *3	
RY(n+1)F			

"n" is depend on the station number.

*1: When RYn0 and RYn1 are ON simultaneously the rotation is followed a parameter F 105 (default = stop).

*2: By the input terminal function selections(F 115 to F 121), change of the function of the input signal is possible.

(But there are functional restrictions. Refer to the following page.)

*3: The reserved input signal should be set OFF ("0").

■ Input function selection from the CC-Link.

The function numbers selection of the RYn2 - RYn8 function valid from the command of the CC-Link are following boldface numbers.

Positive logic	Negative logic	Function	Speed control	Torque control	PM control	V/f
0	1	No function is assigned	●/●	●/●	●	●
2	3	F: Forward run command *4	●/●	●/●	●	●
4	5	R: Reverse run command *4	●/●	●/●	●	●
6	7	ST: Standby *1, 3, 4	●/●	●/●	●	●
8	9	RES: Reset *2, 4	●/●	●/●	●	●
10	11	S1: Preset speed 1	●/●	—	●	●
12	13	S2: Preset speed 2	●/●	—	●	●
14	15	S3: Preset speed 3	●/●	—	●	●
16	17	S4: Preset speed 4	●/●	—	●	●
18	19	Jog run	●/●	—	●	●
20	21	Emergency stop *2	●/●	●/●	●	●
22	23	DC braking	●/●	—	●	●
24	25	Acceleration/deceleration switching 1	●/●	—	●	●
26	27	Acceleration/deceleration switching 2	●/●	—	●	●
28	29	V/f switching signal 1	●/●	—	●	●
30	31	V/f switching signal 2	●/●	—	●	●
32	33	Torque limit switching 1	●/●	●/●	●	●
34	35	Torque limit switching 2	●/●	●/●	●	●
36	37	PID control OFF selection	●/●	—	●	●
38	39	Pattern operation selection 1	●/●	—	●	●
40	41	Pattern operation selection 2	●/●	—	●	●
42	43	Pattern operation continuation signal	●/●	—	●	●
44	45	Pattern operation trigger signal	●/●	—	●	●
46	47	External thermal error	●/●	—	●	●
48	49	Forced switching from communication to local	●/●	—	●	●
50	51	Holding of HD operation (stop the three-wire operation)	●/●	—	●	●
52	53	PID differentiation/integration reset	●/●	—	●	●
54	55	PID forward/reverse switching	●/●	—	●	●
56	57	Forced continuous operation	●/●	—	●	●
58	59	Specified speed operation	●/●	—	●	●
60	61	Acceleration/deceleration suspend signal	●/●	—	●	●
62	63	Power failure synchronized signal	●/●	—	●	●
64	65	My function RUN signal	●/●	●/●	●	●
66	67	Auto-tuning signal	●/●	—	●	●
68	69	Speed gain switching	●/●	—	●	●
70	71	Servo lock signal	●/●	—	●	●
72	73	Simple positioning (positioning loop)	●/●	—	●	●
74	75	Integrating wattmeter display clear	●/●	—	●	●
76	77	Trace back trigger signal	●/●	—	●	●
78	79	Light-load high-speed operation prohibitive signal	●/●	—	●	●
86	87	Binary data write	●/●	●/●	●	●
88	89	Up/Down frequency (up) *1	●/●	—	●	●
90	91	Up/Down frequency (down) *1	●/●	—	●	●
92	93	Up/Down frequency (clear)	●/●	—	●	●
98	99	Forward/reverse selection	●/●	●/●	●	●
100	101	Run/Stop command	●/●	●/●	●	●
102	103	Commercial power/INV switching	●/●	—	●	●
104	105	Frequency reference priority switching *3, 4	●/●	—	●	●
106	107	VI/II terminal priority	●/●	—	●	●
108	109	Command terminal board priority *4	●/●	●/●	●	●
111	111	Parameter editing enabling	●/●	●/●	●	●
112	113	Control switching (torque /position)	●/●	●/●	—	—
122	123	Rapidest deceleration command	●/●	—	●	●
124	125	Preliminary excitation	●/●	●/●	●	●
126	127	Braking request	●/●	—	●	●
130	131	Brake answer back input	●/●	—	●	●
134	135	Traverse permission signal	●/●	—	●	●

*1: Valid any time

*2: Independent of ϵ and d , and all command are valid.

*3: Meaning differ from CC-Link. (ST is free run, frequency reference priority switching. is frequency priority)

*4: This function is assigned by the output signal, the instruction code, etc. by fixation.

(2) Input signal Inverter -> Master unit

The following shows input signals to the master unit. (The output signals for the inverter.)

Device No.	Signal name	Description
RXn0	Forward running	OFF: Other than forward running (during stop or reverse rotation) ON : Forward running
RXn1	Reverse running	OFF: Other than reverse running (during stop pr forward rotation) ON : Reverse running
RXn2	Output terminal selection 1 (OUT1)	The function depends on output terminal function selection 1 (F 130).
RXn3	Output terminal selection 2 (OUT2)	The function depends on output terminal function selection 2 (F 131).
RXn4	Output terminal selection 3 (FL)	The function depends on output terminal function selection 3 (F 132).
RXn5	Output terminal selection 4 (OUT3)	The function depends on output terminal function selection 4 (F 133).
RXn6	Output terminal selection 5 (OUT4)	The function depends on output terminal function selection 5 (F 134).
RXn7	Output terminal selection 6 (R1)	The function depends on output terminal function selection 6 (F 135).
RXn8	Output terminal selection 7 (OUT5)	The function depends on output terminal function selection 7 (F 136).
RXn9	Output terminal selection 8 (OUT6)	The function depends on output terminal function selection 8 (F 137).
RXnA	Output terminal selection 9 (R2)	The function depends on output terminal function selection 9 (F 138).
RXnB	Reserved	Reserved for the system.
RXnC	Monitoring	Switched on when the monitored value is set to RWrn by the monitor command (RYnC) switching on. Switched off when the monitor command (RYnC) is switched off.
RXnD	Frequency setting completion (RAM)	Switched on when the set frequency is written to the inverter by the frequency setting command (RYnD) switching on. Switched off when the frequency setting command (RYnD) is switched off.
RXnE	Torque setting completion (RAM)	Switched on when the set torque is written to the inverter by the torque setting command (RYnE) switching on. Switched off when the torque setting command (RYnE) is switched off.
RXnF	Instruction code execution completion	Switched on on completion of the processing corresponding to the instruction code (RWw+2) which is executed when the instruction code execution request (RYnF) switches on. Switched off when the instruction code execution completion (RXnF) is switched off.
RX(n+1)0 : RX(n+1)7	Reserved	Reserved for the system.
RX(n+1)8	Reserved	Reserved for the system.
RX(n+1)9	Reserved	Reserved for the system.
RX(n+1)A	Error status flag	Switched on when occurred an inverter error or option error (watchdog error, CPU error, ROM error, RAM error). It is not switched on besides that.
RX(n+1)B	Remote station ready	Switched on when the inverter goes into the ready status on completion of initial setting after power-on or hardware reset. (Used as an interlock for read/write from/to the master unit.) Switched off when an inverter error occurs (protective function is activated).
RX(n+1)C : RX(n+1)F	Reserved	Reserved

"n" is depend on the station number.

4.4.2. Remote Register Assignment

Divide the monitor code (RWw n) into half and select the first monitor description (RWr n) from the lower 8 bits and the second monitor description (RWr n) from the higher 8 bits.

(Example) When output voltage is selected for the first monitor and output torque is selected for the second monitor. -> The monitor code is 0703H.

* The hexadecimal value attaches and expresses "H" to the end of a number.

(1) Remote register (Master -> inverter)

RWw signal

Address	Signal name	Description
RWw n	Monitor code	Sets the monitor code to be referenced. By switching on the (RYnC) signal after setting, the specified monitored data is set to (RWrn). The first monitor (RWr n) : RWw n Setting of the lower 8 bits of monitor code. The second monitor (RWr n+1) : RWw n Setting of the higher 8 bits of monitor code.
RWw (n+1)	Set frequency	Specifies the set frequency. After setting the register, a frequency is written after turning on the RYnD. When the writing of the frequency is completed, RXnD turns on, depending on the input command.
	Set torque	Specifies the set torque. After setting the register, a torque is written after turning on the RYnE. When the writing of the torque is completed, RXnE turns on, depending on the input command.
RWw (n+2)	Command code	Sets the command code for actions such as operation mode switching, parameter read, write, error reference, error clear, etc. The command will be executed by turning RYnF on after the register setting is completed. When the command execution is completed, RXnF turns on.
RWw (n+3)	Write data	Sets data specified by the above-mentioned command code (if necessary). If no data needs to be written, the value shall be zero. RYnF is turned on after setting the above-mentioned command code and this register.

"n" is depend on the station number.



Address	Remote register	Address	Remote register	Address	Remote register	Address	Remote register
No.1 { 1E0H 1E1H 1E2H 1E3H	RWw0 RWw1 RWw2 RWw3	No.3 { 1E8H 1E9H 1EAH 1EBH	RWw8 RWw9 RWwA RWwB	No.5 { 1F0H 1F1H 1F2H 1F3H	RWw10 RWw11 RWw12 RWw13	}	}
No.2 { 1E4H 1E5H 1E6H 1E7H	RWw4 RWw5 RWw6 RWw7	No.4 { 1ECH 1EDH 1EEH 1EFH	RWwC RWwD RWwE RWwF	No.6 { 1F4H 1F5H 1F6H 1F7H	RWw14 RWw15 RWw16 RWw17		

(2) Remote register (Inverter -> Master)

RWr signal

Address	Signal name	Description
RWr n	First monitor	When RYnC is on, the monitored value specified to the lower 8 bits of the monitor code (RWwn) is set.
RWr(n+1)	Second monitor (output frequency)	When "0" is set to the higher 8 bits of the monitor code (RWwn), the current output frequency is always set. When other than "0" is set to the higher 8 bits of the monitor code (RWwn) and RYnC is on, the monitored value specified to the higher 8 bits of the monitor code (RWwn) is set.
RWr(n+2)	Response code	When turn on RYnF, the response code correspond to the instruction code of RWw(n+2) is set. When turn on RYnD or RYnE, the response code correspond to the instruction code of RWw(n+2) is set. The value "0" is set for a normal reply and other than "0" is set for data fault, mode error, etc.
RWr(n+3)	Read data	For a normal reply, the reply data to the instruction specified by the instruction code is set.

"n" is depend on the station number.

Address	Remote register	Address	Remote register	Address	Remote register	Address	Remote register
No.1 { 2E0H 2E1H 2E2H 2E3H	RWr0 RWr1 RWr2 RWr3	No.3 { 2E8H 2E9H 2EAH 2EBH	RWr8 RWr9 RWrA RWrB	No.5 { 2F0H 2F1H 2F2H 2F3H	RWr10 RWr11 RWr12 RWr13		
No.2 { 2E4H 2E5H 2E6H 2E7H	RWr4 RWr5 RWr6 RWr7	No.4 { 2ECH 2EDH 2EEH 2EFH	RWrC RWrD RWrE RWrF	No.6 { 2F4H 2F5H 2F6H 2F7H	RWr14 RWr15 RWr16 RWr17	No.64 { 3DCH 3DDH 3DEH 3DFH	RWrFC RWrFD RWrFE RWrFF

4.4.3. Instruction Codes

Code No.	Item		Description
1003H	Command mode selection read		0: Terminal input enabled
2003H	Command mode selection write		1: Operation panel input enabled (including LED/LCD option input) 2: 2-wire RS485 communication input 3: 4-wire RS485 communication input 4: Communication option input
1004H	Frequency setting mode selection read		1: VI/II (voltage/current input) 2: RR/S4 (potentiometer/voltage input) 3: RX (voltage input) 4: Operation panel input enabled (including LED/LCD option unit) 5: 2-wire RS485 communication input
2004H	Frequency setting mode selection write		6: 4-wire RS485 communication input 7: Communication input 8: Optional AI1 (differential current input) 9: Optional AI2 (voltage/current input) 10: UP/DOWN frequency 11: Optional RP pulse input 12: Optional high-speed pulse input 13: Optional binary/BCD input
0072H	Special monitor		0000H to FFFFH : Monitor value selected after choosing instruction code 00F3H.
0073H	Read	Special monitor code read	Read the content that was monitored by special monitor.
00F3H	Write	Special monitor selection	Select the monitor code of special monitor.
0074H	Trip history No.1, No.2 read		Read the No.1 (latest) to No.4 (oldest) trip records. *1
0075H	Trip history No.3, No.4 read		
006DH	Frequency command value (RAM) read		Read the frequency command value (RAM).
006EH	Torque command value (RAM) read		Read the torque command value (RAM).
00EDH	Option frequency command value (EEPROM&RAM) write *2		Write the option frequency command value (EEPROM &RAM).
00EEH	Option torque command value (EEPROM&RAM) write *2		Write the option torque command value (EEPROM&RAM).
00F4H	Trip history clear		9696H : Clear all trip history.
00FCH	Parameter all clear		9696H : Clear all parameters. (Parameters other than proofreading values are made into factory default settings.)
00FDH	Inverter reset		9696H : Reset the inverter.
1000H to 1999H (1000H to 1F99H)	Read parameters (RAM)		To read parameters F000 to F984, add the triple figures that follow Fxxx to 1000H. (Ex: F984 -> 984 + 1000 = 1984) No error occurs when you select 1A00 to 1F99. Because these parameters are for maintenance.
2000H to 2999H	Write parameters (EEPROM&RAM) *2		To write parameters F000 to F984, add the triple figures that follow Fxxx to 2000H.

*1 : The details of an error code are indicated to the following page.

*2 : The Life of EEPROM is approximately ten thousand times.

4.4.4. The details of an error code

The following data are stored as trip history data when the inverter trip occurred.

Error code		Description	Trip display
Decimal No.	Hexadecimal No.		
0	00H	No error	<i>nErr</i>
1	01H	Overcurrent during acceleration	<i>OC1</i>
2	02H	Overcurrent during deceleration	<i>OC2</i>
3	03H	Overcurrent during fixed speed operation	<i>OC3</i>
4	04H	Dynamic braking element overcurrent	<i>OC4</i>
5	05H	U-phase arm overcurrent	<i>OCRA1</i>
6	06H	V-phase arm overcurrent	<i>OCRA2</i>
7	07H	W-phase arm overcurrent	<i>OCRA3</i>
8	08H	Input phase failure	<i>EPH1</i>
9	09H	Output phase failure	<i>EPHO</i>
10	0AH	Overvoltage during acceleration	<i>OP1</i>
11	0BH	Overvoltage during deceleration	<i>OP2</i>
12	0CH	Overvoltage during fixed speed operation	<i>OP3</i>
13	0DH	Inverter overload	<i>OL1</i>
14	0EH	Motor overload	<i>OL2</i>
15	0FH	Dynamic braking resistor overload	<i>OLr</i>
16	10H	Overheating	<i>OH</i>
17	11H	Emergency stop	<i>E</i>
18	12H	EEPROM fault (writing error)	<i>EEP1</i>
19	13H	Initial read error (parameter initialization)	<i>EEP2</i>
20	14H	Initial read error (parameter initialization)	<i>EEP3</i>
21	15H	Inverter RAM fault	<i>Err2</i>
22	16H	Inverter ROM fault	<i>Err3</i>
23	17H	CPU fault	<i>Err4</i>
24	18H	Communication error interruption	<i>Err5</i>
25	19H	Gate array fault	<i>Err6</i>
26	1AH	Output current detector error	<i>Err7</i>
27	1BH	Communication error (<i>FBS1</i> set to 4.)	<i>Err8</i>
29	1DH	Low current operation	<i>UC</i>
30	1EH	Undervoltage (main circuit power supply)	<i>UP1</i>
32	20H	Overtorque	<i>Ot</i>
33	21H	Ground fault	<i>EF1</i>
34	22H		<i>EF2</i>
36	24H	Dynamic braking abnormal element (200V-55kW or larger, 400V-90kW or larger)	<i>OCr</i>

(It continues to the next.)

(Continuation)

Error code		Description	Trip display
Decimal No.	Hexadecimal No.		
37	25H	Overcurrent flowing in element during acceleration (Overheat)	<i>OC 1P</i>
38	26H	Overcurrent flowing in element during deceleration (Overheat)	<i>OC 2P</i>
39	27H	Overcurrent flowing in element during fixed speed (Overheat)	<i>OC 3P</i>
40	28H	Tuning error except <i>E t n 1 to 3</i>	<i>E t n</i>
41	29H	Inverter type error	<i>E t 4P</i>
42	2AH	Analog input terminal overvoltage	<i>E - 10</i>
43	2BH	Abnormal brake sequence	<i>E - 11</i>
44	2CH	Disconnection of encoder	<i>E - 12</i>
45	2DH	Speed error (Over speed)	<i>E - 13</i>
46	2EH	Thermal trip stop command from external device	<i>OH 2</i>
47	2FH	Step-out (for PM motors only)	<i>SOUL</i>
50	32H	Analog input disconnection	<i>E - 18</i>
51	33H	Abnormal CPU2 communication	<i>E - 19</i>
52	34H	V/f control error	<i>E - 20</i>
53	35H	CPU1 fault	<i>E - 21</i>
54	36H	Abnormal logic input voltage	<i>E - 22</i>
55	37H	Add-on option 1 error	<i>E - 23</i>
56	38H	Add-on option 2 error	<i>E - 24</i>
57	39H	Stop position retaining error	<i>E - 25</i>
58	3AH	CPU2 fault	<i>E - 26</i>
84	54H	<i>F 4 10</i> tuning error	<i>E t n 1</i>
85	55H	<i>F 4 12</i> tuning error	<i>E t n 2</i>
86	56H	<i>uL, uLu, F 405 to 407</i> setting error	<i>E t n 3</i>

4.4.5. Description of reply code

When executing the frequency setting (RYnD) and torque setting (RYnE) or instruction code execution (RYnF), check the reply code (RW_r (n+2)) in the remote register after execution.

Reply code

Data (Hexadecimal No.)	Item	Description
0000H	Normal (No error)	Normal completion of instruction code execution.
0001H	Write mode error	Parameter write was attempted during operation other than a stop.
0002H	Parameter selection error	Unregistered code number was set.
0003H	Setting range error	Set data is outside the setting data range.

4.4.6. Description of monitor code

Divide the monitor code (RWw n) into half and select the first monitor data (RWr n) from the lower 8 bits and the second monitor data (RWr n) from the higher 8 bits.

(Example) When output voltage is selected for the first monitor and output torque is selected for the second monitor. -> The monitor code is 0703H.

RWw n	Monitor code
the higher 8 bits	the lower 8 bits
Second monitor description	First monitor description

Monitor code (When an invalid monitor code is set up, monitor value fixes to 0.)

Code Number	Second Monitor Description (the higher 8 bits)	First Monitor Description (the lower 8 bits)	Unit
00H	Output frequency	None monitor (Monitor value is 0)	0.01Hz
01H	Output frequency	Output frequency	0.01Hz
02H *1	Output current	Output current	0.01A
03H	Output voltage	Output voltage	0.1V
04H	None monitor (Monitor value is 0)	None monitor (Monitor value is 0)	—
05H	Frequency command value	Frequency command value	0.01Hz
06H	None monitor (Monitor value is 0)	None monitor (Monitor value is 0)	—
07H	Output torque	Output torque	0.1%
08H	DC voltage	DC voltage	0.1V
09H	PBR load factor	PBR load factor	0.1%
0AH	Motor overload factor (OL2 data)	Motor overload factor (OL2 data)	0.1%
0BH, 0CH	None monitor (Monitor value is 0)	None monitor (Monitor value is 0)	—
0DH	Input power	Input power	0.01kW
0EH	Output power	Output power	0.01kW
0FH	Input terminal information	Input terminal information	—
10H	Output terminal information	Output terminal information	—
11H	Output current (% monitor)	Output current (% monitor)	0.1%
12H	Exciting current	Exciting current	0.01A
13H	None monitor (Monitor value is 0)	None monitor (Monitor value is 0)	—
14H	Cumulative operation time	Cumulative operation time	1h
15H, 16H	None monitor (Monitor value is 0)	None monitor (Monitor value is 0)	—
17H	Accumulation power supply ON time	Accumulation power supply ON time	1h
18H	Motor overload factor	Motor overload factor	0.1%
19H	Integral input power	Integral input power	1kWh
1AH	Integral output power	Integral output power	1kWh
1BH	RR/S4 input	RR/S4 input	—
1CH	VI/II input	VI/II input	—
1DH	RX input	RX input	—
1EH, 1FH	None monitor (Monitor value is 0)	None monitor (Monitor value is 0)	—
20H	Torque command	Torque command	0.1%
21H	Torque current	Torque current	0.1%
22H, 23H	None monitor (Monitor value is 0)	None monitor (Monitor value is 0)	—
24H	PID feedback value	PID feedback value	0.01Hz
25H to 2FH	None monitor (Monitor value is 0)	None monitor (Monitor value is 0)	—

*1: The monitor code "02H" will be overflow when its value more than 327.67A. If that monitor overflowed, use the monitor code "11H".

4.4.7. Description of input terminal information

Data composition of input terminal information (Code No. = 0FH).

Bit	Terminal name	Function (parameter name)	0	1
0	F	Input terminal function selection 1(F 111)	OFF	ON
1	R	Input terminal function selection 2(F 112)		
2	ST	Input terminal function selection 3(F 113)		
3	RES	Input terminal function selection 4(F 114)		
4	S1	Input terminal function selection 5(F 115)		
5	S2	Input terminal function selection 6(F 116)		
6	S3	Input terminal function selection 7(F 117)		
7	S4	Input terminal function selection 8(F 118)		
8	L1	Input terminal function selection 9(F 119)		
9	L2	Input terminal function selection 10(F 120)		
10	L3	Input terminal function selection 11(F 121)		
11	L4	Input terminal function selection 12(F 122)		
12	L5	Input terminal function selection 13(F 123)		
13	L6	Input terminal function selection 14(F 124)		
14	L7	Input terminal function selection 15(F 125)		
15	L8	Input terminal function selection 16(F 126)		

4.4.8. Description of output terminal information

Data composition of input terminal information (Code No. = 10H).

Bit	Terminal name	Function (parameter name)	0	1
0	OUT1	Output terminal function selection 1(F 130)	OFF	ON
1	OUT2	Output terminal function selection 2(F 131)		
2	FL	Output terminal function selection 3(F 132)		
3	OUT3	Output terminal function selection 4(F 133)		
4	OUT4	Output terminal function selection 5(F 134)		
5	R1	Output terminal function selection 6(F 135)		
6	OUT5	Output terminal function selection 7(F 136)		
7	OUT6	Output terminal function selection 8(F 137)		
8	R2	Output terminal function selection 9(F 138)		
9	R3	Output terminal function selection 10(F 168)		
10	R4	Output terminal function selection 11(F 169)		
11 to 15	—	—	—	—

5. Programming examples

This chapter provides programming examples which control the inverter with the PLC.

	Item	Programming Example	Refer to Page
5.1	Reading the inverter status	Reading the inverter status from the buffer memory of the master station.	21
5.2	Setting the command mode	Command mode from CC-Link is confirmed.	22
5.3	Setting the operation commands	Commanding the forward rotation.	23
5.4	Setting the reference frequency	Setting to 50.00Hz.	23
5.5	Setting the monitoring function	Monitoring the output frequency.	24
5.6	Writing a parameter value	Setting the $F \ 3 \ 1 \ 1$ [Reverse-run prohibition selection] to $[\ 1 \ : \ Prohibit \ reverse \ run]$.	24
5.7	Reading a parameter value	Read the parameter $F \ 3 \ 1 \ 1$.	25
5.8	Reading the alarm definitions	Reading the inverter alarms	26
5.9	Inverter reset	Resetting the inverter.	27

System configuration for programming example

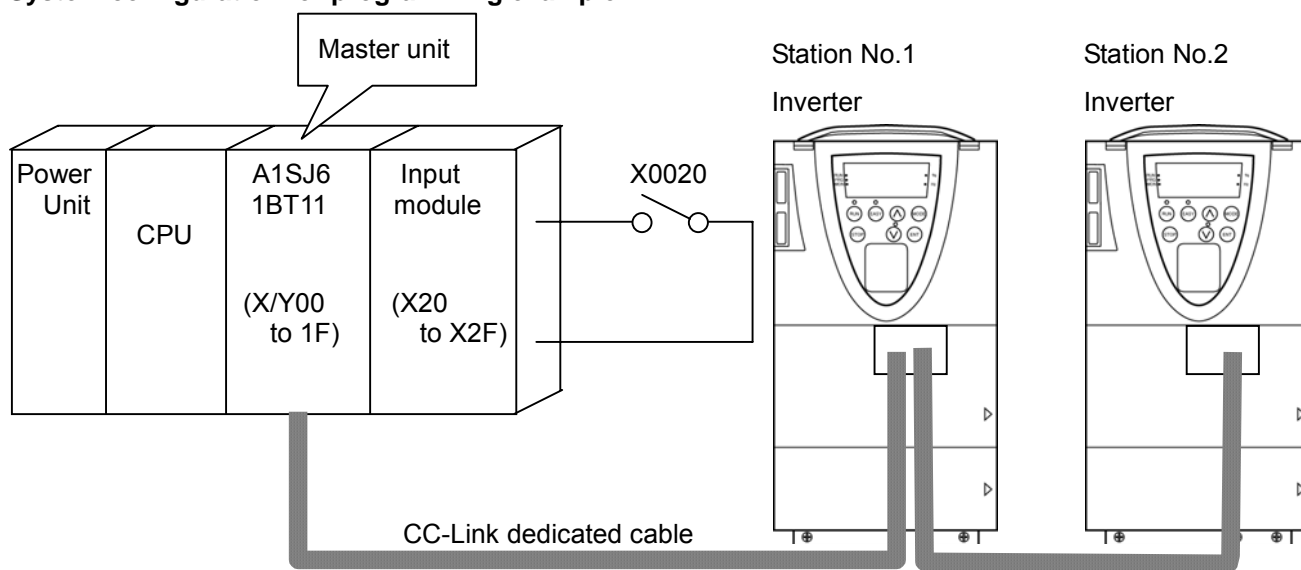

※As for master station, when use the Mitsubishi Electric An series, the recommended version is "LS" or later.

The example of CC-Link communication network composition

• CPU	Mitsubishi Electric Corp.	A1SJHCPU
• Master unit	Mitsubishi Electric Corp.	A1SJ61BT11
• Input module	Mitsubishi Electric Corp.	A1SX40
• CC-Link dedicated cable	Kuramo Electric Corp.	FANC-110SBH
• Inverter	TOSHIBA	TOSVERT VF-AS1 (2 units)
• CC-Link option	TOSHIBA	CCL001Z (2 units)

5.1. Example of the inverter status reading

The following explains a program to read the inverter status from master unit buffer memory.

The following program reads the inverter status of station 2 to M0 – M7 register.

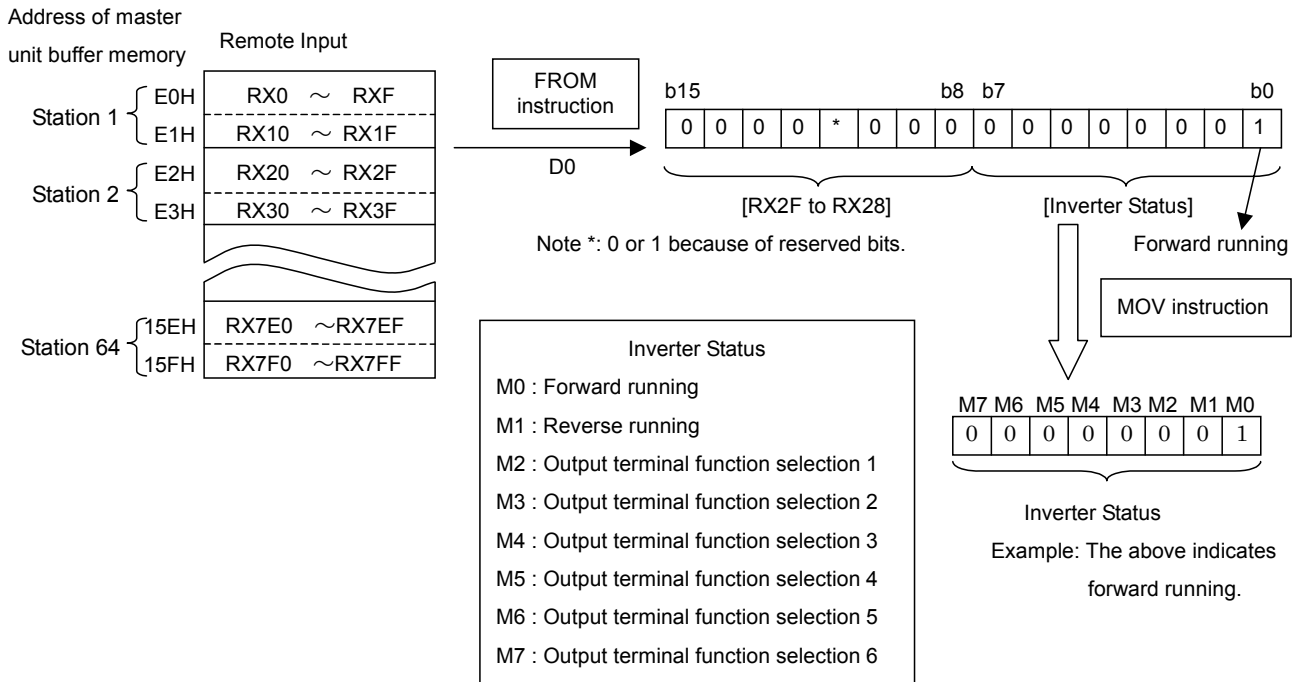
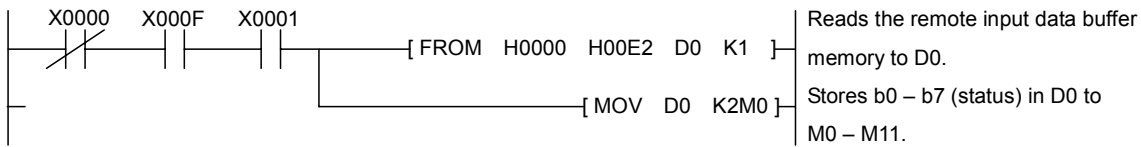

5.2. Example of the command mode setting

The following explains a program to write various data to the inverter.

The following program changes the operation mode of station 1 inverter to CC-Link operation.

Operation mode writing code number : 2003H (Hexadecimal number)

CC-Link operation set data : 0000H (Hexadecimal number)

The reply code at the time of instruction code execution is set to D2.

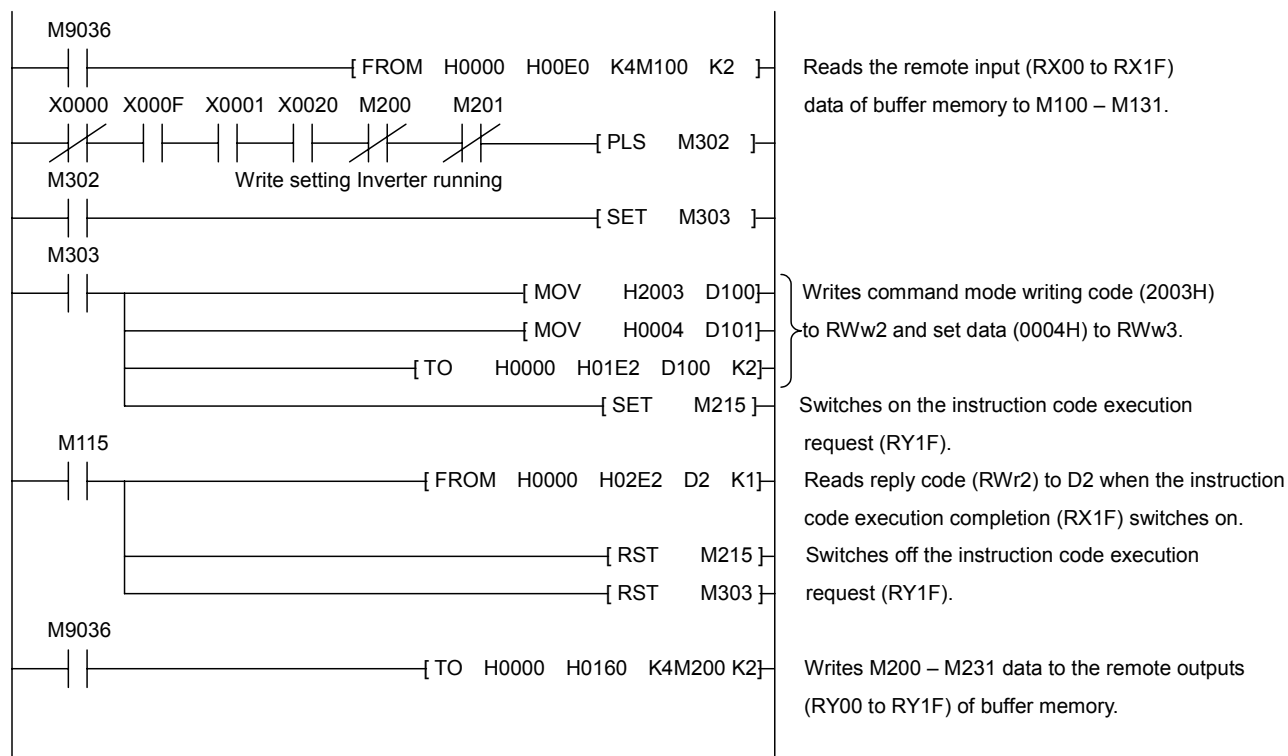

Stores reply code to D2 when the instruction code execution completion.

D2 = 0000H	Normal	Normal completion of instruction code execution.
0001H	Write mode error	Execution improper error. (Write protected during operation)
0002H	Parameter selection error	Unregistered code number was set.
0003H	Setting range error	Set data is outside the permissible data range.

Command mode setting

Code number : 2003H

- Setting data
- 0000H : Terminal input enabled
 - 0001H : Operation panel input enabled
(including LED/LCD option unit)
 - 0002H : 2-wire RS485 communication input
 - 0003H : 4-wire RS485 communication input
 - 0004H : Communication option input

5.3. Example of the operation commands setting

The following explains a program to write a running command for inverter operation to the buffer memory of the master.

The inverter is operated in accordance with the operation commands written to the remote outputs (addresses 160H to 1DFH).

The following program outputs the command of forward rotation signal to station 1 inverter.

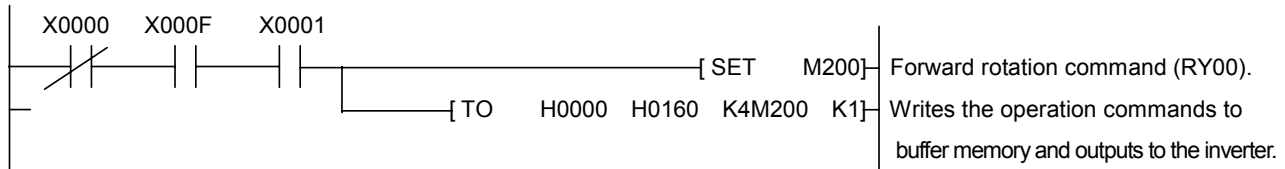

5.4. Example of frequency command setting

The following program changes the running frequency of station 1 inverter to 50.00Hz.

Set frequency : K5000 (Decimal number)

The reply code at the time of instruction code execution is set to D2.

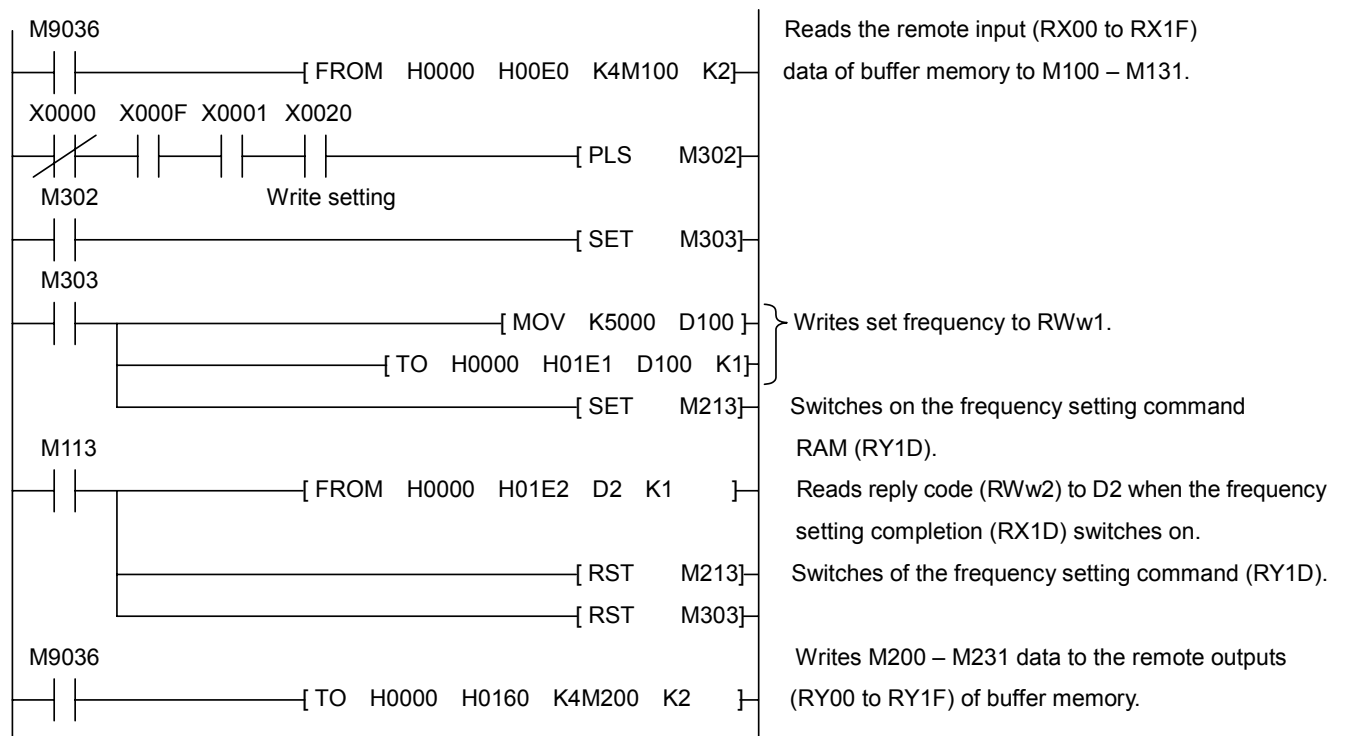

*To continuously change the running frequency from the PLC

When the frequency setting completion (ex.: RX1D) switches on, make sure of that the reply code in the remote register is 0000H and change the set data (ex.: RWw1) continuously.

5.5. Example of the output frequency monitoring

The following explains a program to read monitor functions of the inverter.

The following program reads the output frequency of station 1 inverter to D1.

Example : The output frequency of 50Hz is indicated 1388H (0.01Hz unit).

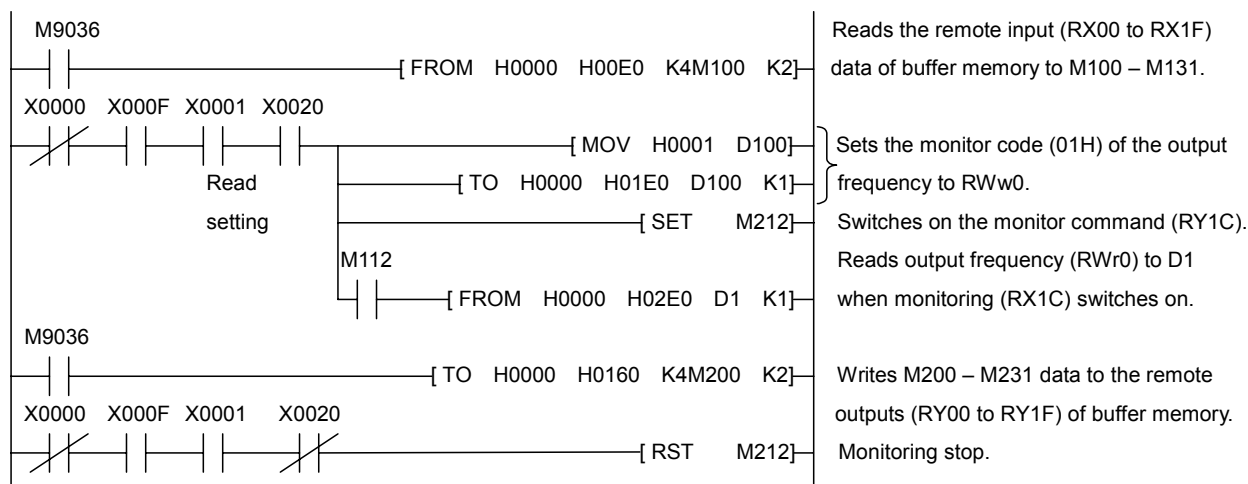

Please refer to "Section 4.4.6. Description of monitor code" about the details of a monitor code.

*When you refer to data by the monitor, be careful of a unit.

5.6. Example of the parameter writing

The following example program changes the $F\bar{3}\bar{1}\bar{1}$ "Reverse-run prohibition selection" setting of station 2 inverter to " $\bar{1}$: Prohibit reverse run".

Reverse-run prohibition selection write code number : 2311H (Hexadecimal number)

Reverse-run prohibition set data : 1 (Decimal number)

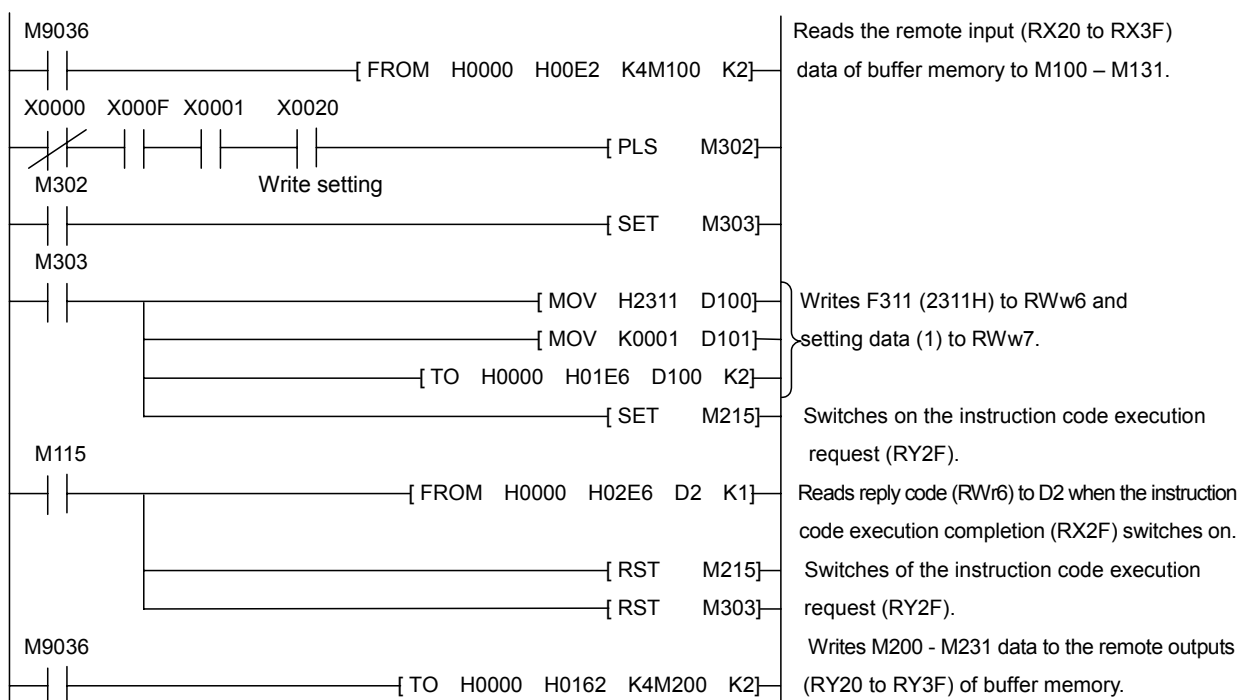

*To write parameters, add the triple figures that follow Fxxx to 2000H.

Example: $F\bar{3}\bar{1}\bar{1}$ -> 2311H

5.7. Example of the parameter reading

The following program reads $F311$ "Reverse-run prohibition selection" of station 2 inverter to D2.

The code of reading "Reverse-run prohibition selection" : 1311H (Hexadecimal number)

The reply code at the time of instruction code execution is set to D1.

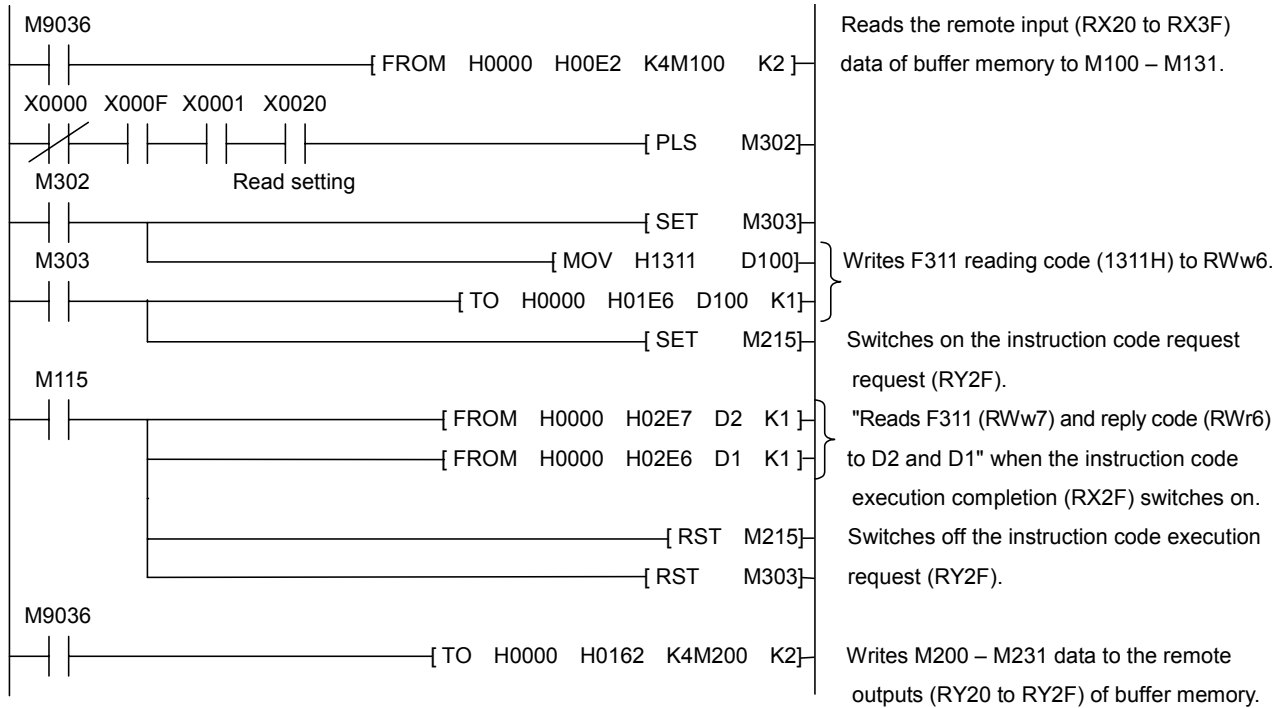

*To read parameters, add the triple figures that follow Fxxx to 1000H.

Example $F311 \rightarrow 1311H$

5.8. Example of the trip history reading

The following program reads the trip history of station 2 inverter to D1.

Trip history No.1, No.2 reading code number :74H (Hexadecimal number)

To reply code at the time of instruction code execution is set to D2.

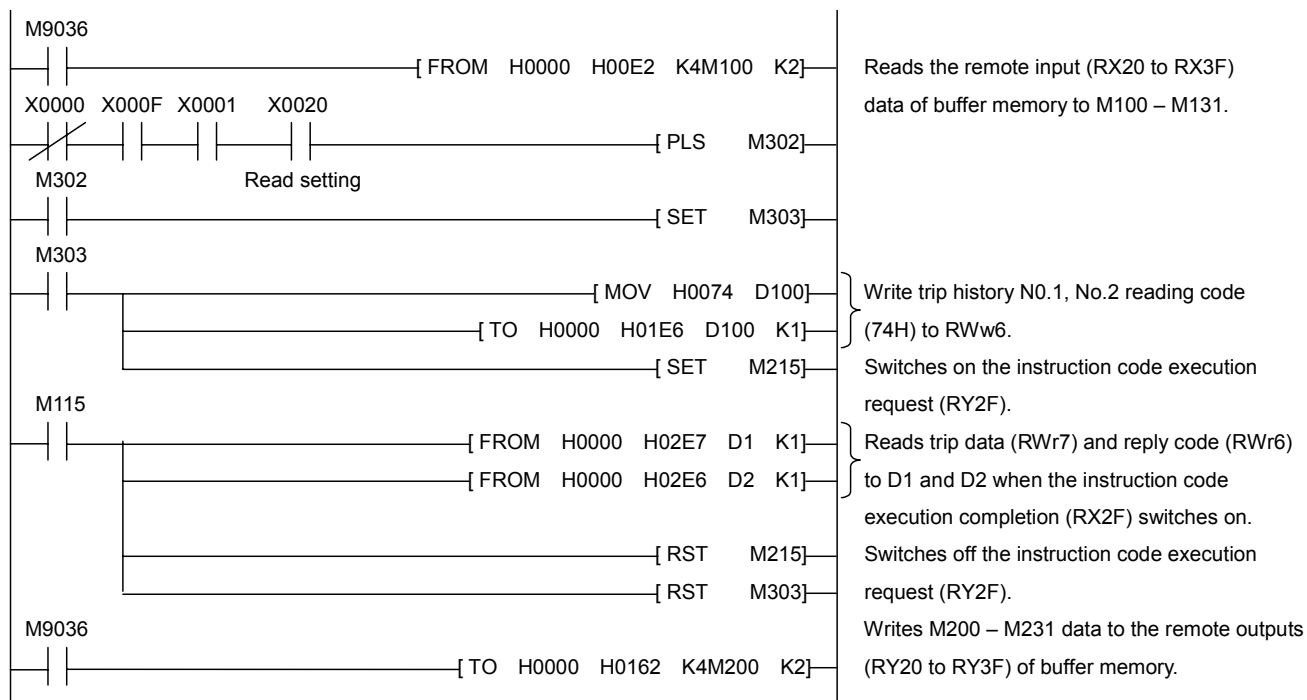

Sample of the display of trip history

Read data.....Case of 2D0EH.

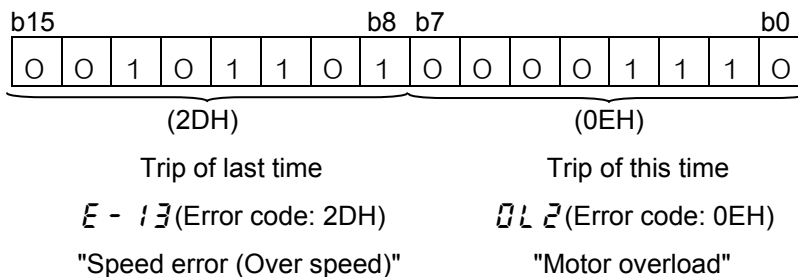

*For details of error code, refer to "Section 4.4.4. The details of an error code".

5.9. Example of the inverter resetting at inverter error

The following program resets the station 1 inverter.

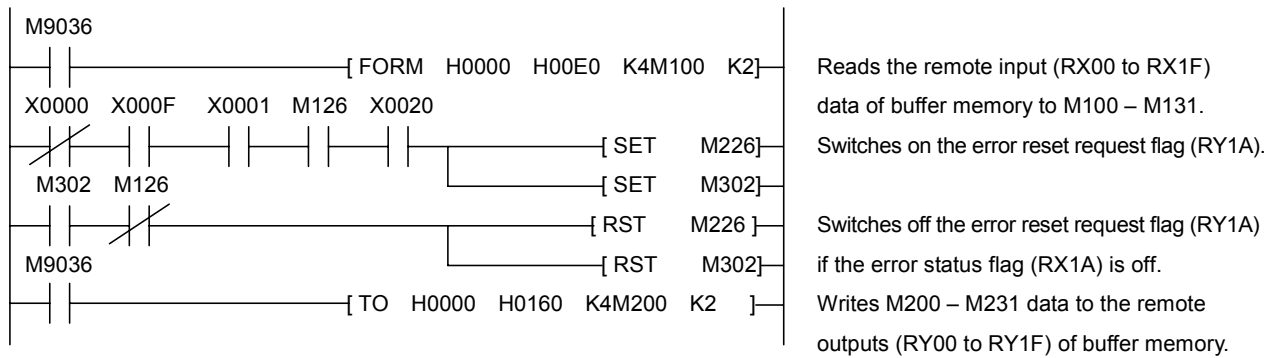

*The above inverter reset using RY1A may be made only when an inverter fault occurs.

Also, inverter reset can be made independently of the operation mode.

*Change the command mode to the network operation mode.

6. Unusual diagnosis

6.1. Option error

The error message is displayed when there is hardware error, software error or lose of connection of wire.

■Display of trip information

$E-23$ (Error code : 55) : Add-on option 1 error

(This error is displayed at the time the bottom side option has an error or only one option is installed and has an error.)

$E-24$ (Error code : 56) : Add-on option 2 error

(This error is displayed at the time the two-units are installed and the upper side option has an error.)

6.2. Disconnection error of network cable

■Display of trip information

$E-r-B$ (Error code : 27) : Communication error

■Related parameter

『 $F850$ Disconnection detection extended time』

The range : 0.0 to 100.0 sec.

The waiting time from when a network error occurs to when a communication error " $E-r-B$ " is displayed can be adjusted. If a network error continues past the time set in $F850$, it is recognized as a communication error and " $E-r-B$ " is displayed.

When normal communication returns during the set time, a communication error is not displayed and operation is continued.

『 $F851$ Inverter operation at disconnection』

The range 0 : Stop and Communication release
(CMOD, FMOD)

1 : None (continued operation)

2 : Deceleration stop

3 : Coast stop

4 : Network error ($E-r-B$ trip)

5 : Preset speed operation (by $F852$ setting)

The action of the inverter when the communication error occurred can be specified.

『 $F852$ Preset speed operation selection』

Setting range 0 : None

1 to 15 : Preset speed operation (by parameter setting)

6.3. How to check the error using the LEDs

The following example explains the causes of fault which may be judged from the LED status of the CC-Link unit (CCL001Z) of the inverter.

(1) When two or more inverters are connected

The following example explains the causes and corrective actions for fault which may be judged from the LED status of the CC-Link units (CCL001Z) of the inverters under the condition that the SW, M/S and PRM LEDs of the master unit are off (the master unit setting is proper) in the system configuration shown below:

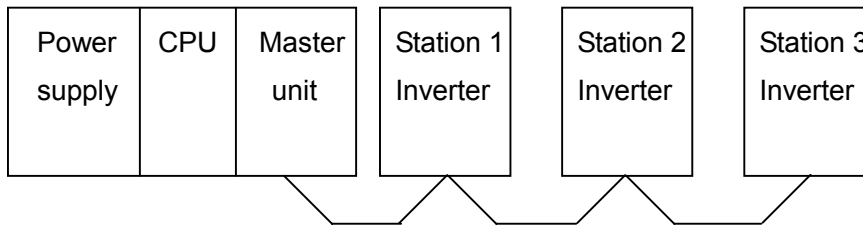

LED Status				Cause	Corrective Action	
Master unit	CCL001Z					
	Station 1	Station 2	Station 3			
TIME○ LINE○ or TIME● LINE○	L.RUN ●	L.RUN ●	L.RUN ●	Normal	—	
	SD ●	SD ●	SD ●			
	RD ●	RD ●	RD ●			
	L.ERR ○	L.ERR ○	L.ERR ○			
TIME○ LINE○	L.RUN ○	L.RUN ●	L.RUN ●	Poor contact of the CCL001Z with the inverter.	Plug the CCL001Z securely. Check the connector.	
	SD ○	SD ●	SD ●			
	RD ○	RD ●	RD ●			
	L.ERR ○	L.ERR ○	L.ERR ○			
TIME● LINE● or TIME○ LINE●	L.RUN ●	L.RUN ○	L.RUN ○	Since the L.RUN LEDs of the CCL001Z on station 2 and later are off, the communication cable between the unit 1 and 2 is open or disconnected from the terminal block.	Referring to the LED "on" condition, search for an open point and repair.	
	SD ●	SD *	SD *			
	RD ●	RD *	RD *			
	L.ERR ○	L.ERR ○	L.ERR ○			
	TIME○ LINE●	L.RUN ○	L.RUN ○	L.RUN ○	The communication cable is shorted.	Among the three wires of the communication cable, search for shorted wire and repair.
		SD *	SD *	SD *		
		RD *	RD *	RD *		
		L.ERR ○	L.ERR ○	L.ERR ○		
	TIME○ LINE●	L.RUN ○	L.RUN ○	L.RUN ○	The communication cable is wired improperly.	Check the wiring on the inverter terminal block and correct the improper wiring point.
		SD *	SD *	SD *		
		RD *	RD *	RD *		
		L.ERR *	L.ERR *	L.ERR *		

●: On, ○: OFF, ◎: Flicker, *: Any of on, flicker or off.

(2) Communication stops during operation

- Check that the CC-Link units and the CC-Link dedicated cable are connected properly.
(Check for contact fault, break in the cable, etc.)
- Check that the PLC program is executed properly.
- Check that data communication has not stopped due to an instantaneous power failure, etc.

Master unit	LED Status			Cause	Corrective Action
	CCL001Z				
	Station 1	Station 2	Station 3		
TIME○ LINE○ or TIME● LINE○	L.RUN ○ SD * RD ● L.ERR ○	L.RUN ● SD ● RD ● L.ERR ○	L.RUN ○ SD * RD ● L.ERR ○	Since the L.RUN LEDs of station 1 and station 3 are off, the station numbers of stations 1 and 3 are duplicated.	After correcting the re-peated station numbers of the inverters, switch power on again.
	L.RUN ● SD ● RD ● L.ERR ○	L.RUN ○ SD ○ RD ● L.ERR ○	L.RUN ● SD ● RD ● L.ERR ◎	Since the L.RUN and SD LEDs of station 2 is off, the communi-cation speed setting of station 2 is wrong within the setting range (0 to 4).	After correcting the communication speed setting, switch power on again.
	L.RUN ● SD ● RD ● L.ERR ○	L.RUN ● SD ● RD ● L.ERR ○	L.RUN ● SD ● RD ● L.ERR ◎	Since the L.ERR LED of station 3 flickers, the setting switch of station 3 was moved during normal operation.	After returning the setting switch to the correct position, power on the inverter again.
	L.RUN ○ SD ○ RD ● L.ERR ●	L.RUN ● SD ● RD ● L.ERR ○	L.RUN ● SD ● RD ● L.ERR ○	The setting switch of station 1 is outside the range (communi-cation speed: 5 to 9, station number: 65 or more).	After correcting the setting switch position of the CCL001Z, power on again.
TIME● LINE● or TIME○ LINE●	L.RUN ● SD ● RD ● L.ERR ○	L.RUN ● SD ● RD ● L.ERR ●	L.RUN ● SD ● RD ● L.ERR ○	Since the L.ERR LED of station 2 is on, it self on station 2 is affected by noise. (L.RUN may go off.)	Securely connection FG of each inverter and master unit to ground.
	L.RUN ● SD ● RD ● L.ERR ○	L.RUN ● SD ● RD ● L.ERR ●	L.RUN ● SD ● RD ● L.ERR ●	Since the L.ERR LEDs of on station 2 and later are on, the communication cable between the inverters of stations 2 and 3 are affected by noise. (L.RUN may go off.)	Check that the communication cable is connected to SLD. Also run it as far away as possible from the power lines.(100mm or more)
	L.RUN ● SD ● RD ● L.ERR ○	L.RUN ● SD ● RD ● L.ERR ○	L.RUN ● SD ● RD ● L.ERR ●	Terminal resistors are left un-connected. (L.RUN may go off.)	Check that the terminal resistors are connected.

●: On, ○: OFF, ◎: Flicker, *: Any of on, flicker or off.