

TOSVERT VF-MB1

PROFIBUS-DP Option Function Manual

PDP003Z

NOTICE

1. Make sure that this function manual is delivered to the end user of VF-MB1 drive.
2. Read this manual before communicating PROFIBUS. Keep it in a safe place for reference.
3. All information contained in this manual are subject to change without notice.
Please confirm the latest information on our web site "www.inverter.co.jp".

Contents

1. Introduction	2
2. Connection Information.....	3
2.1. Exterior features.....	3
2.2. Status indicator	4
2.3. VF-MB1 Communication parameters	5
3. Profile.....	6
3.1. Telegram	6
3.2. STW Control Word Data	7
3.3. ZSW Status Word Data.....	8
3.4. State Machine	10
3.5. Access to the PROFIBUS parameter	12
3.6. PROFIBUS parameter (PNU)	13
3.7. Access to VF-MB1 parameter.....	15
4. Vendor Spec. Profile.....	17
4.1. How to use	18
4.2. The overview of the VF-MB1 parameter.....	19
5. Diagnostic	25
6. DP-V1 function.....	26
6.1. Example 1. Read the PROFIdrive parameter	27
6.2. Example 2. Change the PROFIdrive parameter	28
6.3. Example 3. Read the VF-MB1 parameter.....	29
6.4. Example 4. Change the VF-MB1 parameter.....	30
PROFIBUS Local/Remote Operation	31
7. GSD file.....	31
8. Appendix.....	32

1. Introduction



Thank you for purchasing the PROFIBUS-DP option “PDP003Z” for the VF-MB1. Before using the PROFIBUS-DP option, please familiarize yourself with the product and be sure to thoroughly read the instructions and precautions contained in this manual. In addition, please make sure that this manual and “Installation Manual” is delivered to the end user, and keep this function manual in a safe place for future reference or drive/interface inspection.

This manual describes the supported functions for the “PDP003Z”.



In conjunction with this manual, the following manuals are supplied by Toshiba, and they are essential both for ensuring a safe, reliable system installation as well as for realizing the full potential of the “PDP003Z”:



- TOSVERT VF-MB1 Instruction Manual.....E6581697
- VF-MB1 Option Installation Manual.....E6581739

■ Handling in general

 Danger	
 Mandatory	<ul style="list-style-type: none"> ▼ Do not connect or disconnect a network cable while the drive power is on. It may lead to electric shocks or fire. ▼ See Installation manual attached with the option unit for cautions the handling. Otherwise, it may lead to electric shocks, fire, injuries or damage to product.

■ Network control

 Danger	
 Prohibited	<ul style="list-style-type: none"> ▼ Do not send the value out of the valid range to network variables. Otherwise, the motor may suddenly start/stop and that may result in injuries.
 Mandatory	<ul style="list-style-type: none"> ▼ Use an additional safety device with your system to prevent a serious accident due to the network malfunctions. Usage without an additional safety device may cause an accident.

 Warning	
 Mandatory	<ul style="list-style-type: none"> ▼ Set up “Communication error trip function (see below)” to stop Drive when the network is deactivated by an unusual event such as tripping, an operating error, power outage, failure, etc. <ul style="list-style-type: none"> - PROFIBUS communication timeout (C 100) - Drive operation at the communications loss action (C 101) - Preset speed operation selection (C 102) - Communication time-out condition selection (C 103) Deactivated Drive may cause an accident, if the “Communication error trip function” is not properly set up. ▼ Make sure that the operation signals are STOP before resetting Drive’s fault. The motor may suddenly start and that may result in injuries.

■ Notes on operation

Notes	
	<ul style="list-style-type: none"> ▼ When the control power is shut off by the instantaneous power failure, communication will be unavailable for a while. ▼ The Life of EEPROM is approximately 100,000 times. Avoid writing a command more than 100,000 times to the same parameter of the drive and the communication board.

2. Connection Information

This option allows the VF-MB1 drive to be communicated with the cyclic command transmission and monitoring of the original profile ("Vendor spec.", refer to Section 4) of our company other than application profile "Profile for Variable Speed Drives PROFIdrive (3.072), refer to Section 3" which PROFIBUS defines.

2.1. Exterior features

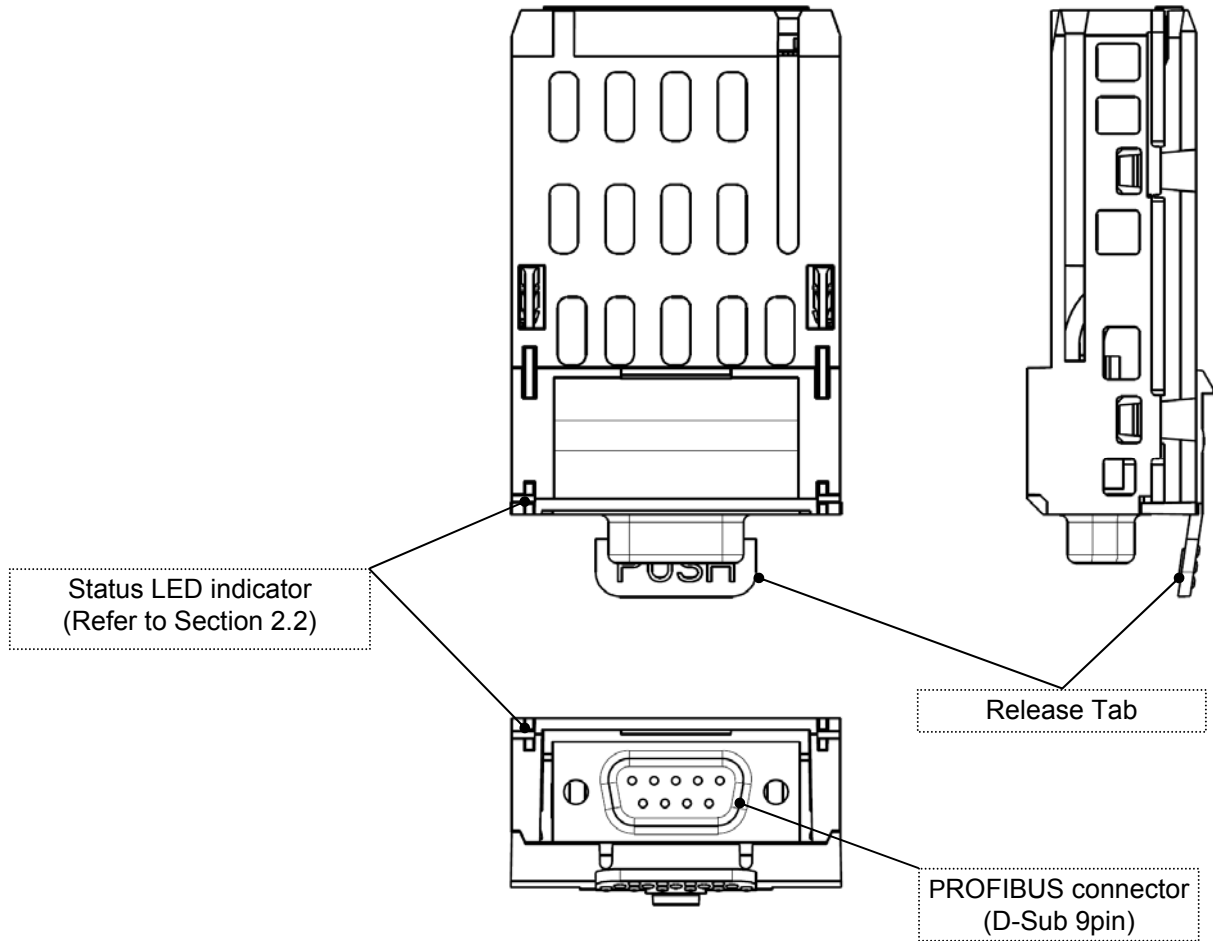

To align VF-MB1 side-by-side horizontally, "Vertical" type PROFIBUS connector is necessary.

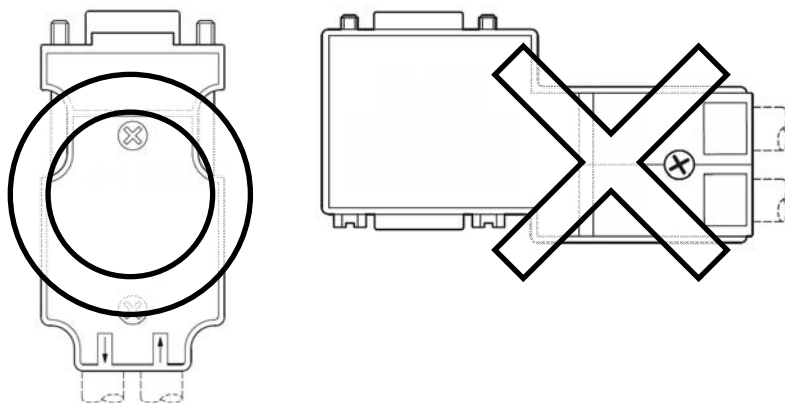

2.2. Status indicator

The PDP003Z has two LEDs, ST (status) and DX (data exchange) to indicate the statuses of PROFIBUS-DP and the PDP003Z itself.

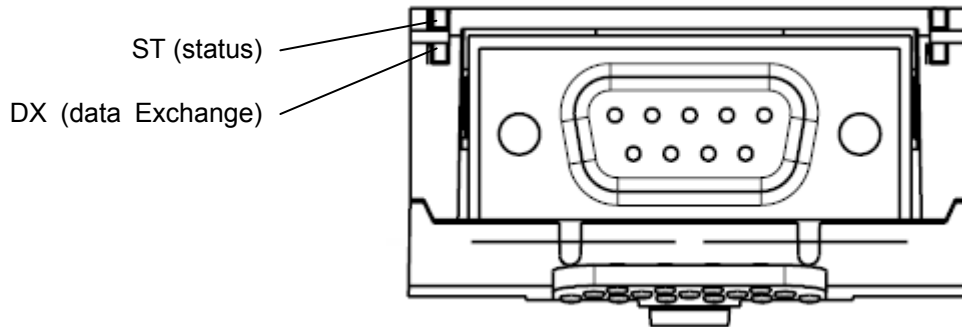

ST (Status): Red LED

LED	Meanings
Off	No diagnostics present
Flashes	8 Hz (Blinking 4 times/1sec.): Waiting for parameterization or configuration
	2 Hz (Blinking 1 times/1sec.): PDP003Z station address is "126". (Refer to section .)
Lights	DP status error * For example, a station address is not setcorrectly.

DX (Data exchange): Green LED.

Indicates the status of the PROFIBUS network.

It lights when the PDP003Z is on-line and data exchange is possible.

2.3. VF-MB1 Communication parameters

In a network, VF-MB1 (PDP003Z) serves as a DeviceNet slave device. PDP003Z configuration is set by the following parameters.

Parameter	Function	Adjustment range	Default setting
<i>Ⓒ 150</i>	PDP003Z Station address	2 to 126	126
<i>Ⓒ 151</i>	PDP003Z Baud rate Monitor	0: 12 Mbit/s 1: 6 Mbit/s 2: 3 Mbit/s 3: 1.5 Mbit/s 4: 500 kbit/s 5: 187.5 kbit/s 6: 93.75 kbit/s 7: 19.2 kbit/s 8: 9.6 kbit/s	-
<i>Ⓒ 152</i>	PDP003Z Profile Monitor	0 : Telegram 1 (PROFIdrive) 1 : Telegram 100 (Vender Spec. 1) 2 : Telegram 101 (Vender Spec. 2) 3 : Telegram 102 (Vender Spec. 3)	-
<i>Ⓒ 154</i>	JOG1 Frequency (STW.8)	0.0 to 20.0Hz	5.0Hz
<i>Ⓒ 155</i>	JOG2 Frequency (STW.9)	0.0 to 20.0Hz	5.0Hz
<i>Ⓒ 156</i>	Tmax (ZSW.8)	0.1 to 60.0s	10.0s
<i>Ⓒ 157</i>	Tolerance (ZSW.8)	0.1 to 99.0%	50.0%
<i>Ⓒ 100</i>	PDP003Z Communication time-out	0.0 to 100.0 sec	0.0
<i>Ⓒ 101</i>	Drive operation at the communications loss action (Network wire breaks)	0: Stop and Communication release * (follows <i>Ⓒ 100d</i> and <i>F 100d</i> setting) 1: None 2: Deceleration stop 3: Coast stop 4: Emergency stop 5: Preset speed operation command (Operating at the preset speed operation frequency set with <i>Ⓒ 102</i>)	4
<i>Ⓒ 102</i>	Preset speed operation selection	0: None 1 to 15: Preset speed (<i>Sr 1 - Sr 7, F 287 - F 295</i>)	0
<i>Ⓒ 103**</i>	Communication time-out condition selection	0: Disconnection detection 1: When communication mode enable (Both <i>Ⓒ 100d</i> and <i>F 100d</i> are set CANopen or COM option) 2: 1+Driving operation	1
<i>F 899</i>	Network option reset setting	0: None 1: Resetting the PDP003Z and the drive	0
<i>F d57</i>	PDP003Z version	PDP003Z firmware version (ex. 0x1101 means "V1.01")	-

* Do not set at VF-MB1 **V1.00**.

** It is necessary to enable "Watchdog" function with the configurator.

*** When the parameters are changed, the power must be cycled (or set *F 899* to 1) to the VF-MB1 for the changes to take effect.

**** When *F 100d* or *Ⓒ 100d* is set to "Communication option", VF-MB1 drives without Net Reference (STW Bit 13) or Net Control (STW Bit 12) at PROFIdrive.

3. Profile

3.1. Telegram

Telegram of PDP003Z is set up by the configurator.
 The figures below show the Telegrams and configurations that the PDP003Z supports.

PKW			PZD					
PKE	IND	PWE	PZD1 STW ZSW	PZD2 HSW HIW	PZD3	PZD4	PZD5	PZD6

Telegram 1: PROFIdrive (PPO TYPE 3, 2PZD)



Telegram 100: Vendor Spec. (PPO TYPE 1, 4PKW / 2PZD)



Telegram 101: Vendor Spec. (PPO TYPE 2, 4PKW / 6PZD)



Telegram 102: Vendor Spec. (PPO TYPE 4, 6 PZD)



- PKW: Parameter ID/value
- PZD: Process Data, cyclically transferred

- PKE: Parameter ID (1st and 2nd octet)
- IND: Sub-index (3rd octet), 4th octet is reserved
- PWE: Parameter value (5th until 8th octet)

- STW: Control word
- HSW: Main setpoint

- ZSW: Status word
- HIW: Main actual value

* There are some by which a high byte / low byte is conversely treated depending on a master.

3.2. STW Control Word Data

PDP003Z supports only speed control mode.

Bit	Value	Name	Note
0	1	ON	"Switched on" condition
	0	OFF	Normal stop.
1	1	No Coast Stop	All "Coast Stop (OFF2)" commands are withdrawn
	0	Coast Stop (OFF 2)	Coast stop.
2	1	No Quick Stop	All "Quick Stop (OFF3)" commands are withdrawn.
	0	Quick Stop (OFF 3)	Emergency Stop.
3	1	Enable Operation	The drive then runs-up to the setpoint.
	0	Disable Operation	Normal stop.
4	1	Enable Ramp Generator	-
	0	Reset Ramp Generator	Output of the RFG is set to 0.
5	1	Unfreeze Ramp Generator	-
	0	Freeze Ramp Generator	Freeze the actual setpoint entered by the RFG *.
6	1	Enable Setpoint	The value selected at the input of the RFG is switched-in.
	0	Disable Setpoint	The value selected at the input of the RFG is set to 0.
7	1	Fault Acknowledge	Fault reset (0 -> 1)
	0	No meaning	-
8	1	JOG 1 ON **	VF-MB1 drives with JOG 1 speed 1 (ƒ 15 4).
	0	JOG 1 OFF	Jogging stop, if "JOG 1" was previously ON. Stop drive according to VF-MB1 setting parameter.
9	1	JOG 2 ON **	VF-MB1 drives with JOG 2 speed 2 (ƒ 15 5).
	0	JOG 2 OFF	Jogging stop, if "JOG 2" was previously ON. Stop drive according to VF-MB1 setting parameter.
10	1	Control By PLC	The control word and main setpoint are activated.
	0	No Control By PLC	The control word and main setpoint are inactivated.
11	---	Device-specification	(Reserved.)
12	1	Net Control	PDP003Z control is enabled.
	0	Local Control	PDP003Z control is disabled.
13	1	Net Reference	PDP003Z reference is enabled.
	0	Local Reference	PDP003Z reference is disabled.
14	---	Device-specification	(Reserved.)
15	---	Device-specification	(Reserved.)

* RFG: Ramp Function Generator

** Operation is enabled, drive is in standstill and STW1 bit 4, 5, 6 = 0.

3.3. ZSW Status Word Data

Bit	Valure	Name	Note
0	1	Ready To Switch-on	Power supply is switched on
	0	Not Ready To Switch-on	-
1	1	Ready To Operate	Refer to control word, bit 1.
	0	Not Ready To Operate	-
2	1	Operation Enabled	Drive follows setpoint. (Refer to control word 1, bit 3)
	0	Operation Disabled	-
3	1	Fault Present	VF-MB1 tripped.
	0	No Fault	VF-MB1 is not tripped.
4	1	Coast Stop Not Activated	-
	0	Coast Stop Activated (OFF 2)	"Coast Stop (OFF 2)" command is present.
5	1	Quick Stop Not Activated	-
	0	Quick Stop Activated (OFF 3)	"Quick Stop (OFF 3)" command is present
6	1	Switching On Inhibited	Control word bit1 or 2 is set to 0 or fault trip has been acknowledged.
	0	Switching On Not Inhibited	-
7	1	Warning Present	Drive still operational: Alarm in service parameter: No acknowledgement.
	0	No Warning	Alarm not present or alarm has disappeared again
8	1	Speed Error Within Tolerance Range	Refer to section 3.3.1.
	0	Speed Error Out Of Tolerance Range	
9	1	Control Requested	VF-MB1 is controlled by PROFIBUS master.
	0	No Control Requested	VF-MB1 is controlled by another interface.
10	1	f Or n Reached Or Exceeded	Actual value \geq Comparison value (setpoint)
	0	f Or n Not Reached	-
11	----	Device-specification	(Reserved.)
12	----	Device-specification	(Reserved.)
13	----	Device-specification	(Reserved.)
14	----	Device-specification	(Reserved.)
15	----	Device-specification	(Reserved.)

3.3.1. Tolerance Range (ZSW Bit 8)

If the setpoint is changed:

1. ZSW Bit 8 is set 0
2. Calculate the tolerance.
3. Start the timer which will time-out based on parameter Tmax.

PDP003Z checks that the timer (Tmax) has not timed-out and if the actual value is within the tolerance. If both conditions are fulfilled ZSW Bit 8 is set 1 and the timer is stopped.

The figure shows ZSW 8 when Tolerance (L 15 7) is 50% and Tmax (L 15 1) is 3s.

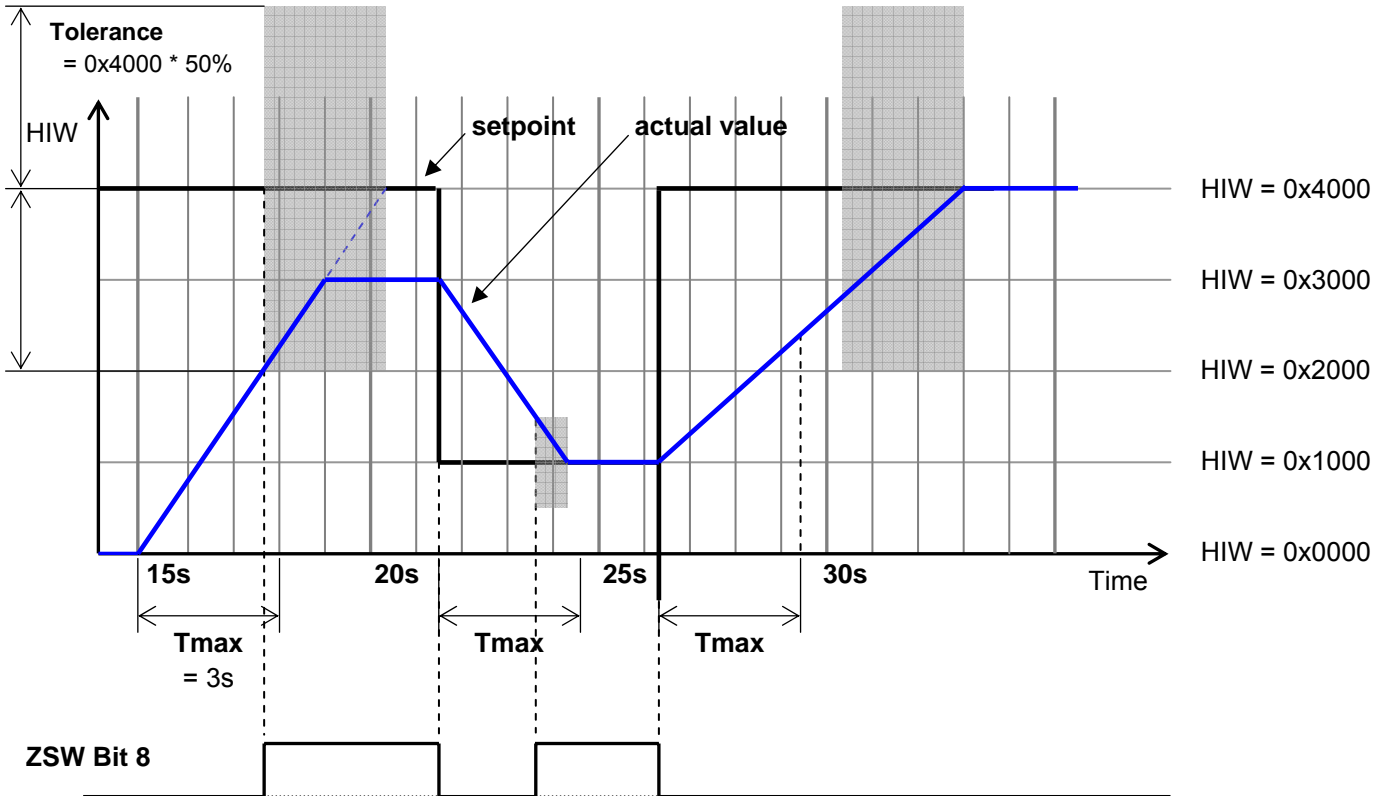

3.4. State Machine

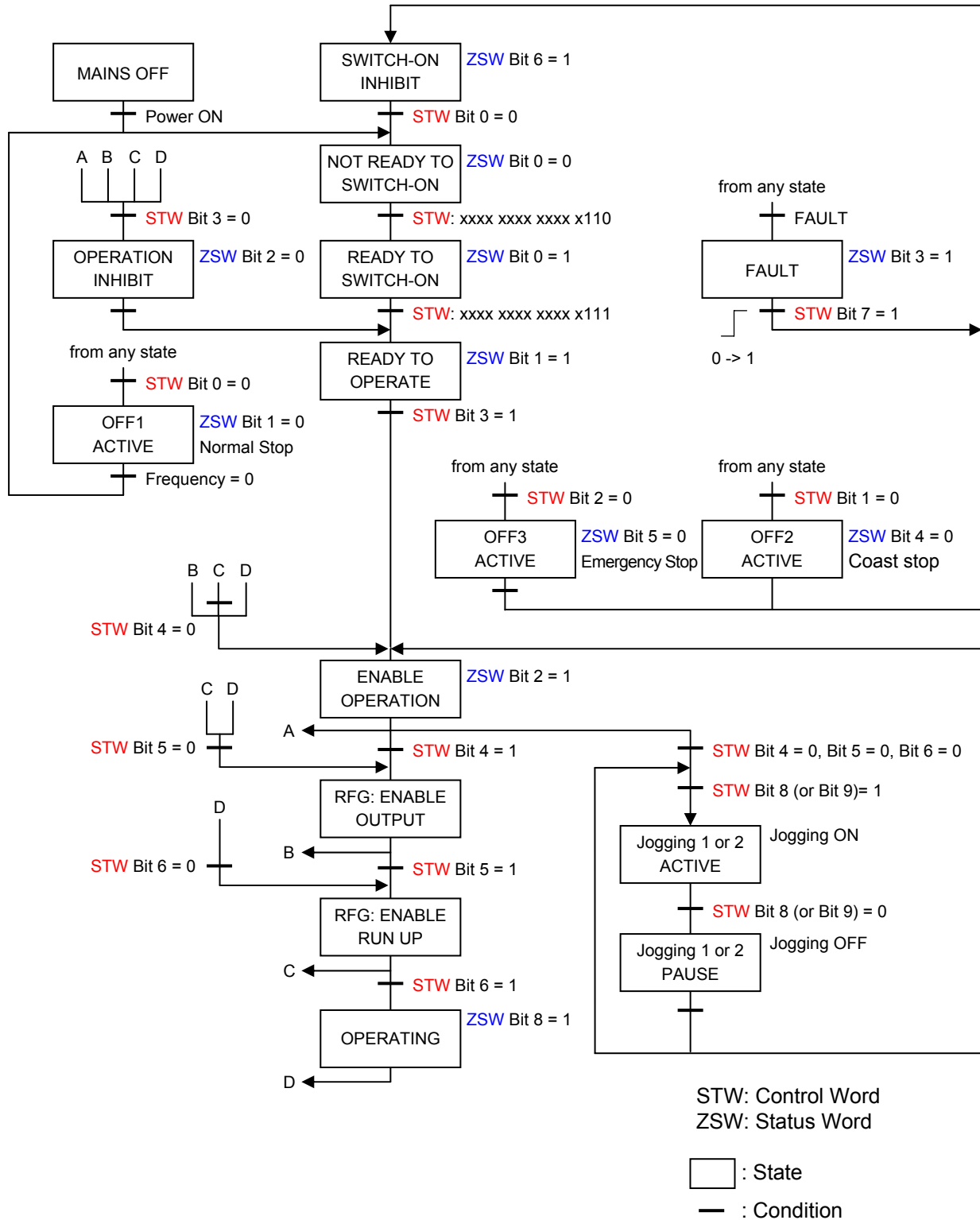

Notes

- ▼ STW Bit 10, 12 = 1 or $\overline{CND} = 4$ is needed for above control.
- ▼ If \overline{CND} is set to Local (0, 1, 2 or 3), set 1 to STW Bit10 and 12 first after turning on the power supply of VF-MB1.
- ▼ Check ZSW always and take care to give the command to STW.

3.4.1. Examples of driving by the State Machine

When using the PROFIdrive profile, the frequency reference is set to HSW. The setting value "0x0000" - "0x4000" is equivalent to "0" - "Base frequency (parameter FH)".
 When the reverse operation, the frequency reference is set with two's complement of the forward frequency reference. During running, HIW shows a output frequency.
 * F_{ref} or ζ_{ref} is set to "Communication option" on these examples.

3.4.1.1. Example 1. 60Hz Forward running and Deceleration stop

Set "0x4000" to HSW and the following is set to STW in order.

```

① 0000 0100 0000 0110 (= 0x0406)
   ↓
   "READY TO SWITCH-ON"
   ↓
② 0000 0100 0000 0111 (= 0x0407)
   ↓
   "READY TO OPERATE"
   ↓
③ 0000 0100 0111 1111 (= 0x047F)
   ↓
   "OPERATION"
   ↓
④ 0000 0100 0111 1110 (= 0x047E)
   ↓
   "OFF1 ACTIVE (Normal Stop)"
  
```

3.4.1.2. Example 2. 30Hz Reverse running

When the reverse operation, "0xE000" is set to HSW. "0xE000" is two's complement of the "0x2000" as the forward frequency reference 30Hz.
 The Setup to STW is same as the Example 1.

3.4.1.3. Example 3. Inching and pause

the following is set to STW in order.

```

① 0000 0100 0000 0110 (= 0x0406)
   ↓
   "READY TO SWITCH-ON"
   ↓
② 0000 0100 0000 0111 (= 0x0407)
   ↓
   "READY TO OPERATE"
   ↓
③ 0000 0101 0000 1111 (= 0x050F)
   ↓
   "Jogging 1 ACTIVE"
   ↓
④ 0000 0100 0100 1111 (= 0x040F)
   ↓
   "Jogging 1 PAUSE"
  
```

* The inching frequency is according to the parameter ζ_{154} , ζ_{155} on VF-MB1.

3.5. Access to the PROFIBUS parameter

In the cyclic PROFIBUS-DP communication, the parameter data is transferred via Telegram 100, 101. If the requirement is not executed, the cause is distinguished by octet 7 and 8.

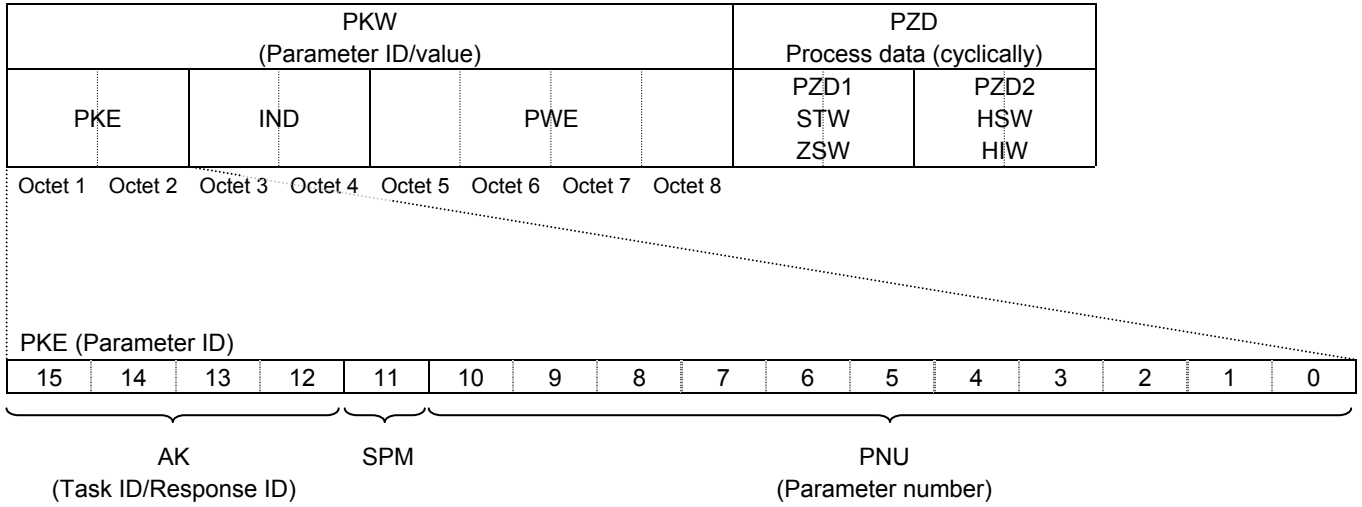

AK (Request from Master to PDP003Z)

Request ID	Function	Note
0	No task	
1	Request parameter value	for PNU access
2	Change parameter value (word)	for PNU access
6	Request parameter value (array)	for PNU access, VF-MB1 parameter access
7	Change parameter value (array)	for PNU access, VF-MB1 parameter access

AK (Response from PDP003Z to Master)

Response ID	Function
0	No response
1	Transfer parameter value (word)
4	Transfer parameter value (array)
7	Task can not be executed, followed by error number 0 = Illegal parameter number 1 = Parameter value cannot be changed 2 = Lower or upper limit violated 3 = Erroneous sub index 11 = No parameter change rights 17 = Task cannot be executed due to operating status (e.g. parameter is currently read-only) 18 = Other error 102 = Request not supported

SPM: always 0.

3.6. PROFIBUS parameter (PNU)

PNU	R/W	data type	Note
915	R	Array [6] Unsigned16	PNU 915, IND 0 = the drive parameter $\llcorner 001$ PNU 915, IND 1 = the drive parameter $\llcorner 002$ PNU 915, IND 2 = the drive parameter $\llcorner 003$ PNU 915, IND 3 = the drive parameter $\llcorner 004$ PNU 915, IND 4 = the drive parameter $\llcorner 005$ PNU 915, IND 5 = the drive parameter $\llcorner 006$
916	R	Array [6] Unsigned16	PNU 916, IND 0 = the drive parameter $\llcorner 021$ PNU 916, IND 1 = the drive parameter $\llcorner 022$ PNU 916, IND 2 = the drive parameter $\llcorner 023$ PNU 916, IND 3 = the drive parameter $\llcorner 024$ PNU 916, IND 4 = the drive parameter $\llcorner 025$ PNU 916, IND 5 = the drive parameter $\llcorner 026$
918	R	Unsigned16	Station address monitor (same as the drive parameter $\llcorner 150$).
922	R	Unsigned16	Telegram selection 1, 100, 101, 102
927	R/W	Unsigned16	Operator control rights (parameter identification, PKW). Value: Mode 0: Parameters cannot be written, only read (927 can be written). 1: Parameters can be written and read (default).
928	R	Unsigned16	Control rights (process data, PZD). 1: PZD part is enabled.
930	R	Unsigned16	Operating mode 1 : supports the speed control mode and the speed setpoint channel comprises RFG functionality.
944	R	Unsigned16	Fault message counter
947	R	Array [1] Unsigned16	Fault number
963	R	Unsigned16	Detected baud rate: 0 = 9.6 kbit/s 1 = 19.2 kbit/s 2 = 93.75 kbit/s 3 = 187.5 kbit/s 4 = 500 kbit/s 6 = 1.5 Mbit/s 7 = 3 Mbit/s 8 = 6 Mbit/s 9 = 12 Mbit/s
964	R	Array [5] Unsigned16	Drive Unit identification IND 0 = PDP003Z ID (0x0C24) IND 1 = Manufacturer-ID (0x0190) IND 2 = VF-MB1 CPU1 version IND 3 = VF-MB1 firmware release year (yyyy) IND 4 = VF-MB1 firmware release date (ddmm)
965	R	Octet String2	Profile number of the PDP003Z (Profidrive, V4.1)

3.6.1. Examples of reading the PROFIdrive parameter

3.6.1.1. Example 1. Reading the PNU 922 (Telegram)

AK = 1 (Request parameter value)
 SPM = 0
 PNU = 922 (0x039A)

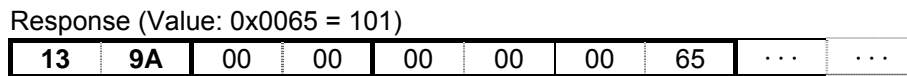
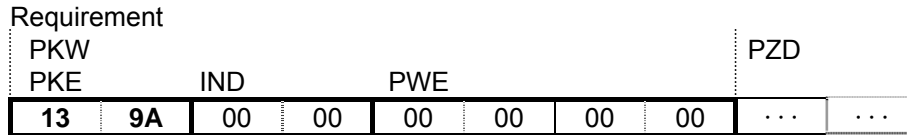
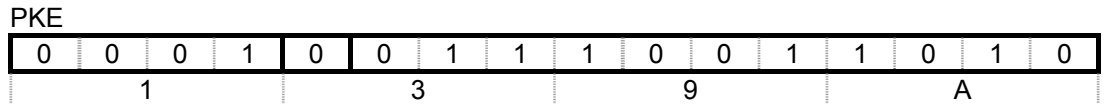

3.6.1.2. Example 2. Reading the PNU 964, IND 0

AK = 6 (Request parameter value (array))
 SPM = 0
 PNU = 964 (0x03C4)
 IND = 0 (PDP003Z ID)

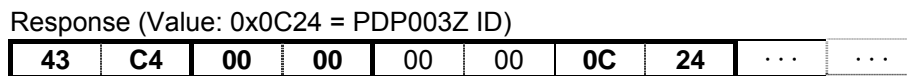
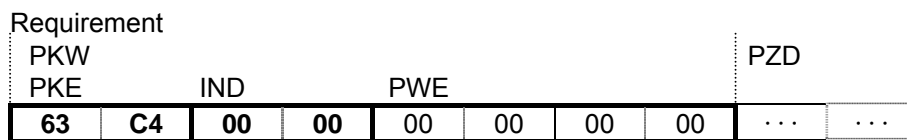
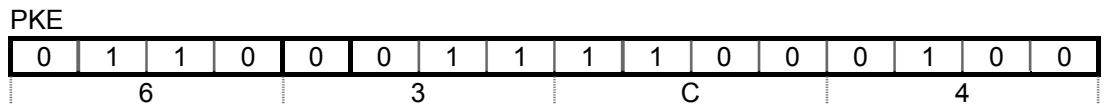

3.7. Access to VF-MB1 parameter

When access to VF-MB1 parameter, set "1" to the PNU. The communication number of the drive parameter is set to the subindex IND.

Refer to the drive instruction manual about the communication number and unit.

* This procedure changes the value of VF-MB1 EEPROM.

3.7.1. Examples of reading or changing VF-MB1 parameter

3.7.1.1. Example 1. Reading the basic parameter (CND (command mode selection))

AK = 6 (Request parameter value (array))
 SPM = 0
 PNU = 1
 IND = 0x0003 (CND communication number)

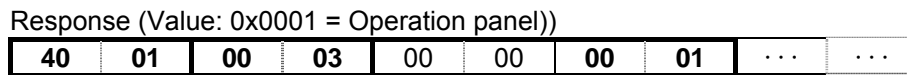
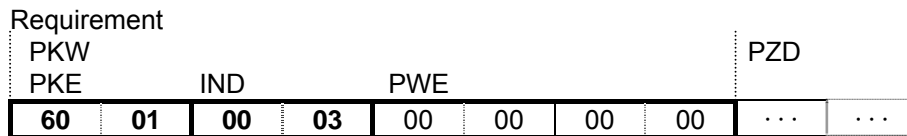
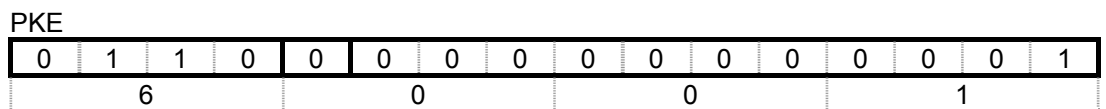

3.7.1.2. Example 2. Reading the extended parameter (F219 (VIC input point 2 frequency))

AK = 6 (Request parameter value (array))
 SPM = 0
 PNU = 1
 IND = 0x0219 (F219 communication number)

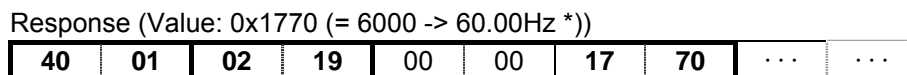
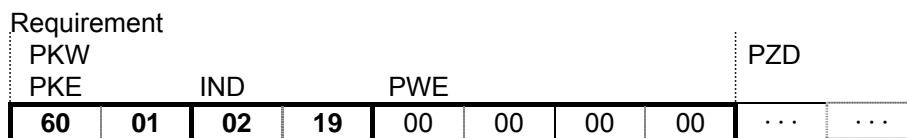
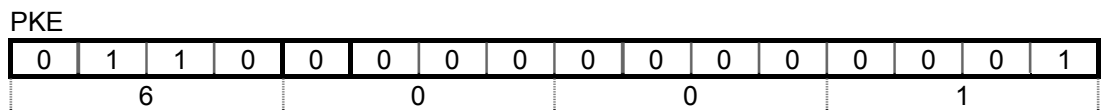

* "0x1770" as reading value of "VIC input point 2 frequency" is
 0x1770 = 6000 (decimal number)
 Since the unit of "VIC input point 2 frequency" is 0.01Hz, set the following value.
 6000 × 0.01 = 60.00Hz

3.7.1.3. Example 3. Reading the status monitor parameter (F E 0 2 (The operation frequency))

AK = 6 (Request parameter value (array))
 SPM = 0
 PNU = 1
 IND = 0xFE02 (F E 0 2 communication number)

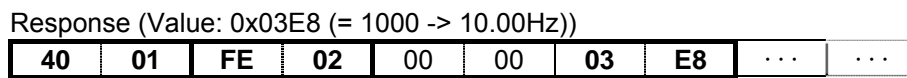
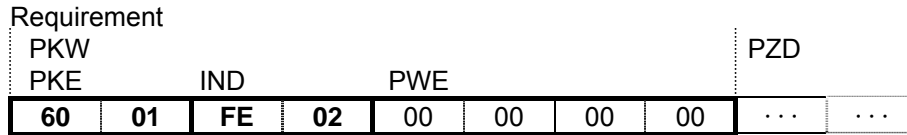
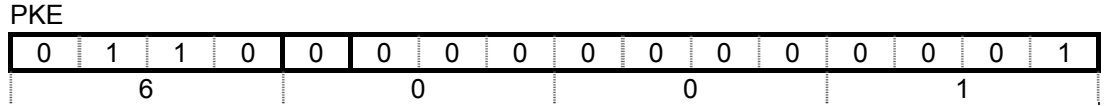

* The status monitor parameter can not be changed.

3.7.1.4. Example 4. Changing the basic parameter (A 0 0 9 (acceleration time))

AK = 7 (Change parameter value (array word))
 SPM = 0
 PNU = 1
 IND = 0x0009 (A 0 0 9 communication number)

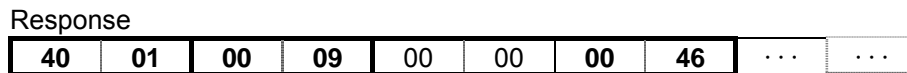
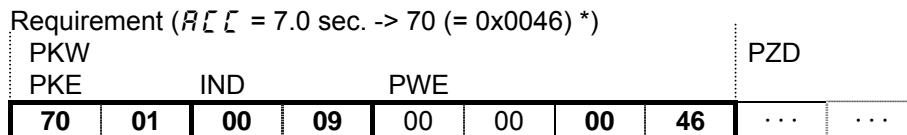
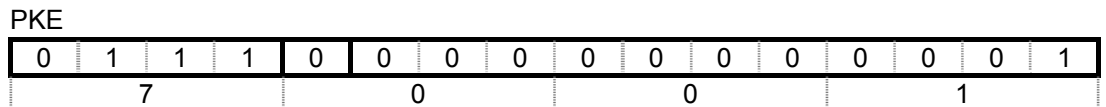

* When the "Acceleration time" is set to 7.0 sec., set the following value.
 (The unit of the "Acceleration time" is according to the parameter F 5 1 9.)
 7.0/0.1 = 70 = 0x0046 (hexadecimal number)

Notes	
	<ul style="list-style-type: none"> ▼ When the control power is shut off by the instantaneous power failure, communication will be unavailable for a while. ▼ The Life of EEPROM is approximately 100,000 times. Avoid writing a command more than 100,000 times to the same parameter of the drive and the communication board.

4. Vendor Spec. Profile

Cyclic command transmission (the value of the parameter $C001 - C006$) and monitoring (the value of the parameter $C021 - C026$) are possible for PDP003Z by the original profile

Select the "Telegram 100", "Telegram 101" or "Telegram 102" as the profile on the configuration. Refer to the PLC configurator documents.

$C001 - C006$ setup value	$C021 - C026$ setup value
0: No action	0: No action
1: $F006$ (Communication command 1)	1: $Fd01$ (drive status 1)
2: $F023$ (Communication command 2)	2: $Fd00$ (Output frequency, 0.01Hz)
3: $F007$ (Communication frequency command, 0.01Hz)	3: $Fd03$ (Output current, 0.01%)
5: $F050$ (Terminal output)	4: $Fd05$ (Output voltage, 0.01%)
6: $F051$ (Analog output (FM) data from comm.)	5: $F091$ (drive alarm)
8: $F501$ (Stall prevention level, %)	6: $Fd22$ (PID feedback value, 0.01Hz)
13: $R00$ (Power running torque limit 1 level, 0.01%)	7: $Fd06$ (Input terminal status)
14: $d00$ (Regenerative braking torque limit 1 level, 0.01%)	8: $Fd07$ (Output terminal status)
15: UL (Upper limit frequency)	9: $FE36$ (VIB input)
16: ub (Torque boost)	10: $FE35$ (VIA input)
17: uLu (Speed loop stabilization coefficient)	11: $FE37$ (VIC input)
	12: $Fd04$ (Input voltage (DC detection), 0.01%)
	13: $Fd16$ (Estimated speed)
	14: $Fd18$ (Torque, 0.01%)
	19: $F880$ (Free notes)
	20: $Fd29$ (Input power, 0.01kW)
	21: $Fd30$ (Output power, 0.01kW)
	22: $FE14$ (Cumulative operation time, 1 hour)
	23: $FE40$ (FM terminal output monitor)
	25: $Fd20$ (Torque current, 0.01%)
	26: $Fd23$ (Motor overload, 0.01%)
	27: $Fd24$ (drive overload, 0.01%)
	28: $Fd25$ (PBr overload, 1%)
	29: $Fd26$ (Motor load (Real time), 1%)
	30: $Fd27$ (drive load (Real time), 1%)
	31: $FE56$ (RP pulse input)
	32: $FE70$ (Monitor of rated current, 0.1A)
	33: $FE76$ (Input watt hour, 0.01kWh) *
	34: $FE77$ (Output watt hour, 0.01kWh) *
	35: $Fd83$ (CTN measurement temperature)

* The unit of $FE76$, $FE77$ is according to the parameter $F749$.

4.1. How to use

The purposes are adjustment by real time command transmission, and the monitor of an operation state by using cyclic communication of PROFIBUS.

Example 1: Command transmitting

When you want to set "0xC400" to parameter *FA06*, set "1 (FA06)" to parameter *LD01*.

And Since 0 and 1 byte of the PZD1 supports the parameter *LD01*, if "0xC400" is set up here, "0xC400" will be set as *FA06*.

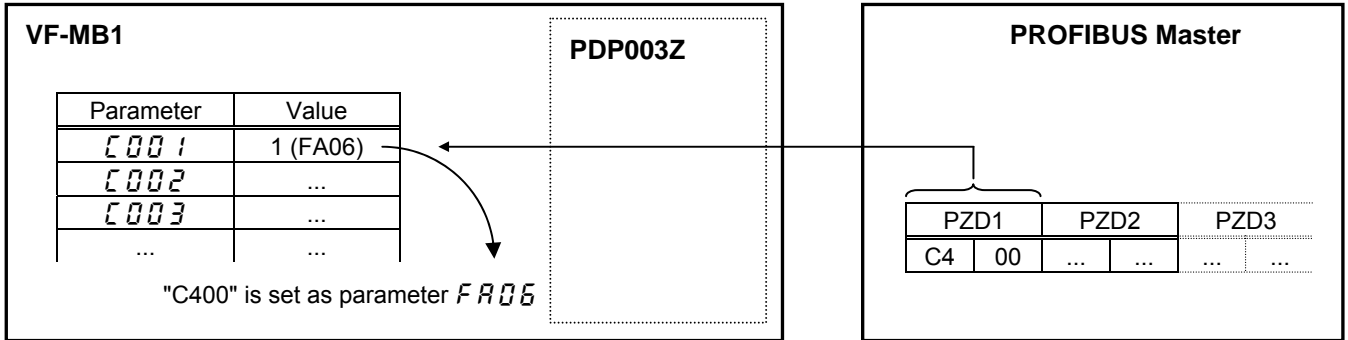

Example 2: State monitoring

When you want to monitor the output current, set "3 (FD03)" to parameter *LD01*.

The value of the parameter *FD03* specified as 0 and1 byte of the PZD1 with the parameter *LD01* is inputted.

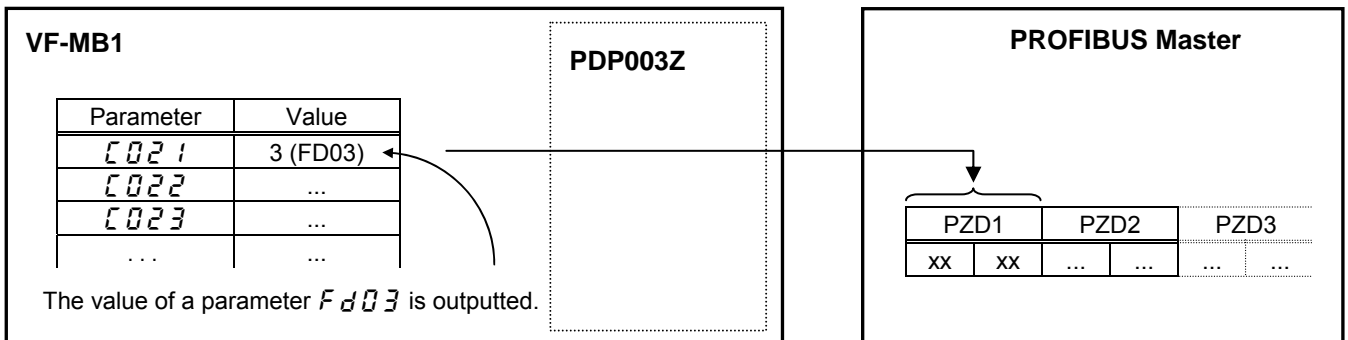

4.2. The overview of the VF-MB1 parameter

Refer to a communication functional description (VF-MB1: E6581315) for details.

4.2.1. FA06 (Command word 1 from internal option)

bit	Function	0	1	Note
0	Preset Speed1	OFF 0000, 1 - 15 0001 - 1111		Combination of 4 bits.
1	Preset Speed2			
2	Preset Speed3			
3	Preset Speed4			
4	THR1/2	Motor 1 (THR1)	Motor 2 (THR2)	THR1: $t H_r$ THR2: $F 173$
5	PI off	Normal	PI off	-
6	ACC1/ACC2	ACC 1 (AD1)	ACC 2 (AD2)	AD1: RCC, dEC AD2: $F500, F501$
7	DC braking	OFF	DC braking	-
8	Jog	OFF	JOG RUN	-
9	Forward/Reverse	Fw.	Rev.	-
10	Run/stop	STOP	RUN	-
11	Free run (ST)		Free run	-
12	Emergency stop	OFF	EMG./ Stop	Always enable
13	Reset trip	OFF	Reset	-
14	Frequency link	OFF	Priority	Enable in spite of the parameter $F70d$
15	Command link	OFF	Priority	Enable in spite of the parameter $C70d$

4.2.2. FA23 (Command word 2 from internal option)

bit	Function	0	1	Note
0	-	-	-	-
1	Clear kwh	OFF	Clear	Clear the value of $FE76, FE77$
2	(Reserved)	-	-	-
3	(Reserved)	-	-	-
4	(Reserved)	-	-	-
5	(Reserved)	-	-	-
6	(Reserved)	-	-	-
7	Fast Stop	Normal	ON	-
8	ACC1/ACC2	00: Acc. / Dec. 01: Acc. / Dec. 2		Combination of 2 bits. AD1: RCC, dEC AD2: $F500, F501$ AD3: $F510, F511$
9	ACC3	10: Acc. / Dec. 3 11: Acc. / Dec. 3 (same as "10")		
10	(Reserved)	-	-	-
11	(Reserved)	-	-	-
12	Torque Limit 1/2	-	-	-
13	(Reserved)	-	-	-
14	(Reserved)	-	-	-
15	(Reserved)	-	-	-

4.2.3. FA07 (Frequency reference from internal option PCB)

Frequency reference is set up by 0.01Hz unit and the hexadecimal number.
 For example, when "Frequency reference" is set up to 80Hz, since the minimum unit is 0.01Hz,
 $80 / 0.01 = 8000 = 0x1F40$ (Hex.)

4.2.4. FA50 (Terminal output data from comm.)

By setting up the data of the bit 0 - 1 of terminal output data (*F A 5 0*) from communication, setting data (0 or 1) can be outputted to the output terminal.
 Please select the functional number 92 - 95 as the selection (*F 1 3 0 - F 1 3 8*) of the output terminal function before using it.

bit	Output TB function name	0	1
0	Communication data 1 (Output TB select No.: 92, 93)	OFF	ON
1	Communication data 2 (Output TB select No.: 94, 95)		
2	-		

4.2.5. FA51 (Analog output (FM) data from comm.)

The data set as the parameter *F A 5 1* can output to FM terminal.
 The data adjustment range is 0 - 1000.
 Please select 18 (*F A* set value is displayed for adjustments) as FM terminal meter selection parameter (*F A 5 L*) before using it.
 Please refer to "Meter setting and adjustment" Section of the VF-MB1 instructions manual for details.

4.2.6. FD01 (Drive status (real time))

bit	Function	0	1	Note
0	FL	No output	Under output	-
1	EMG	No fault	Under fault	The <i>r t r y</i> status and the trip retention status are also regarded as tripped statuses.
2	ALARM	No alarm	Under alarm	-
3	(Reserved)	-	-	-
4	tHr2(VF2+tH2)	Motor 1 (THR1)	Motor 2 (THR2)	THR1: <i>t H r</i> THR2: <i>F 1 7 3</i>
5	PI	PI enable	PI off	-
6	ACC1/ACC2	Acc./Dec. 1 (AD1)	Acc./Dec. 2 (AD2)	AD1: <i>A C C , d E C</i> AD2: <i>F 5 0 0 , F 5 0 1</i>
7	DC braking	OFF	DC braking	-
8	Jog	OFF	JOG RUN	-
9	Forward /Reverse	Fwd. RUN	Rev. RUN	-
10	Run/stop	STOP	RUN	-
11	Free run (ST)	ST=ON	ST=OFF	-
12	Emergency stop	No EMG. Stop	Under EMG. Stop	-
13	READY with ST/ RUN	-	-	ST = ON and RUN = ON in addition to "ready for operation" *
14	READY without ST/RUN	-	-	-
15	(Reserved)	-	-	-

* Ready for operation: Initialization completed, not a stop due to a failure, no alarm issued, not *n o f f*, not a forced stop due to *L L*, not a forced stop due to a momentary power failure.

4.2.7. FD00 (Output frequency (real time))

The current output frequency is read into 0.01Hz of units and by the hexadecimal number.

For example, when the output frequency is 80Hz, 0x1F40 (hexadecimal number) are read.

Since the minimum unit is 0.01%,

$$0x1F40 \text{ (Hex.)} = 8000 \text{ (Dec.)} * 0.01 = 80 \text{ (Hz)}$$

Also about the following parameters, these are the same as this.

- *F d 2 2* (Feedback value of PID (real time)).....Unit: 0.01Hz
- *F d 1 5* (PG feedback or Estimated speed (real time))Unit: 0.01Hz
- *F d 2 9* (Input power (real time)).....Unit: 0.01kW
- *F d 3 0* (Output power (real time)).....Unit: 0.01kW

4.2.8. FD03 (Output current (real time))

The current output current is read into 0.01% of units and by the hexadecimal number.

For example, when the output current of the rated current 4.8A drive is 50% (2.4A), 0x1388 (hexadecimal number) is read.

Since the minimum unit is 0.01%,

$$0x1388 \text{ (Hex.)} = 5000 \text{ (Dec.)} * 0.01 = 50 \text{ (%)}$$

Also about the following parameters, these are the same as this.

- *F d 0 5* (Output voltage(real time))Unit: 0.01% (V)
- *F d 0 4* (Voltage at DC bus (real time))Unit: 0.01%(V)
- *F d 1 8* (Torque)Unit: 0.01% (Nm) *

* When the motor information connected to the drive set to the parameter (*F 4 0 5* - *F 4 1 5*), torque monitor value "100%" is same as the rated torque of a motor in general.

4.2.9. FE36 (Analog input value VIB)

The value inputted into the VIB terminal is read.
 The value range is 0xD8F0 - 0x2710 (-100.00 - 100.00 %).

4.2.10. FE37 (VIC Input)

The value inputted into the VIC terminal is read.
 The value range is 0x0 - 0x2710 (0 - 100.00 %).

Also the same as the parameter *FE35* (VIA Input).

4.2.11. FE14 (Cumulative run time)

The operated cumulative time is read by the hexadecimal number.
 For example, when cumulative operation time is 18 hours, 0x12 (18 hours) is read.
 0x12 (Hex.) = 18 (Dec., hour)

4.2.12. FE40 (Analog output (FM))

The output value of FM terminal is read.
 The value range is set to 0 - 10000 (0x2710).

4.2.13. FC91 (Alarm code)

bit	Function	0	1	Note
0	Over current alarm	Normal	Under alarm	"L" blinking
1	Drive over load alarm	Normal	Under alarm	"L" blinking
2	Motor over load alarm	Normal	Under alarm	"L" blinking
3	Over heat alarm	Normal	Under alarm	"H" blinking
4	Over voltage alarm	Normal	Under alarm	"P" blinking
5	Under voltage of main power	Normal	Under alarm	-
6	(Reserved)	-	-	-
7	Under current alarm	Normal	Under alarm	-
8	Over torque alarm	Normal	Under alarm	-
9	OLr alarm	Normal	Under alarm	-
10	Cumulative run-time alarm	Normal	Under alarm	-
11	Option communication alarm	Normal	Under alarm	-
12	Serial communication alarm	Normal	Under alarm	-
13	MOFFMS (MS relay off or MOFF)	Normal	Under alarm	-
14	Stop after instantaneous power off	-	Dec., Under stop	Refer to <i>F302</i> value
15	Stop after LL continuance time	-	Dec., Under stop	Refer to <i>F256</i> value

4.2.14. FD06 (Input TB Status)

bit	TB Name	Function (Parameter)	0	1
0	F	The function is selected by <i>F 111</i>	OFF	ON
1	R	The function is selected by <i>F 112</i>		
2	RES	The function is selected by <i>F 113</i>		
3	S1	The function is selected by <i>F 114</i>		
4	S2	The function is selected by <i>F 115</i>		
5	S3	The function is selected by <i>F 116</i>		
6	VIB	The function is selected by <i>F 117</i>		
7	VIA	The function is selected by <i>F 118</i>		

4.2.15. FD07 (Output TB Status)

bit	TB Name	Function (Parameter)	0	1
0	RY	The function is selected by <i>F 130</i>	OFF	ON
1	OUT	The function is selected by <i>F 131</i>		
2	FL	The function is selected by <i>F 132</i>		
3 - 15	(Reserved)	-		

4.2.16. FC90 (Drive fault)

Data (hexa- decimal)	Data (decimal)	Code	Description
0	0	<i>nErr</i>	No error
1	1	<i>OC1</i>	Over-current during acceleration
2	2	<i>OC2</i>	Over-current during deceleration
3	3	<i>OC3</i>	Over-current during constant speed operation
4	4	<i>OCL</i>	Over-current in load at startup
5	5	<i>OCA</i>	U-phase arm over-current
8	8	<i>EPH1</i>	Input phase failure
9	9	<i>EPH0</i>	Output phase failure
A	10	<i>OP1</i>	Over-voltage during acceleration
B	11	<i>OP2</i>	Over-voltage during deceleration
C	12	<i>OP3</i>	Over-voltage during constant speed operation
D	13	<i>OL1</i>	Over-LOAD in drive
E	14	<i>OL2</i>	Over-LOAD in motor
F	15	<i>OLr</i>	Dynamic braking resistor overload
10	16	<i>OH</i>	Overheat
11	17	<i>E</i>	Emergency stop
12	18	<i>EEP1</i>	EEPROM fault
13	19	<i>EEP2</i>	Initial read error
14	20	<i>EEP3</i>	Initial read error
15	21	<i>Err2</i>	Drive RAM fault
16	22	<i>Err3</i>	Drive ROM fault
17	23	<i>Err4</i>	CPU fault
18	24	<i>Err5</i>	Communication time-out error
1A	26	<i>Err7</i>	Output current detector error
1B	27	<i>Err8</i>	Option error
1C	28	<i>Err9</i>	External keypad disconnection with run command
1D	29	<i>UC</i>	Low current operation status
1E	30	<i>UP1</i>	Under-voltage (main circuit)
20	32	<i>Ot</i>	Over-torque trip
22	34	<i>EF2</i>	Ground fault trip
28	40	<i>Et_n</i>	Tuning error
29	41	<i>Et_{YP}</i>	Drive type error
2A	42	<i>E-10</i>	Analog input terminal over-voltage
2D	45	<i>E-13</i>	Speed error
2E	46	<i>OH2</i>	External thermal
2F	47	<i>SOUT</i>	Step-out (for PM motors only)
32	50	<i>E-18</i>	Terminal input error
33	51	<i>E-19</i>	Abnormal CPU2 communication
34	52	<i>E-20</i>	V/f control error
35	53	<i>E-21</i>	CPU1 fault
37	55	<i>E-23</i>	Option 1 error
3A	58	<i>E-26</i>	CPU2 fault
3B	59	<i>PrF</i>	Safe torque off error
3E	62	<i>OL3</i>	Main module overload
54	84	<i>Et_{n1}</i>	<i>F410</i> tuning error
55	85	<i>Et_{n2}</i>	<i>F412</i> tuning error
56	86	<i>Et_{n3}</i>	Motor constant setting error
40	64	<i>E-32</i>	PTC fault
41	65	<i>Ot2</i>	Over-torque trip 2
43	67	<i>E-35</i>	IOC error
45	69	<i>E-37</i>	Servo lock error

5. Diagnostic

When the communication loss occurs, PDP003Z returns the diagnosis telegram including the following information.

- Byte 1: Station Status 1
- Byte 2: Station Status 2
- Byte 3: Station Status 3
- Byte 4: Master station address
- Byte 5: PDP003Z Ident Number high byte (0x0C)
- Byte 6: PDP003Z Ident Number low byte (0x24)

- Byte 7: Diagnostic data length
- Byte 8: Status Type (Status message = 0x81)
- Byte 9: Slot Number (Slot number = 0x00)
- Byte 10: Specifier (0=No further diff, 1=Status comes, 2=Status goes)

- Byte 11: External diagnostic data length
- Byte 12: PDP003Z Station Address
- Byte 13: PDP003Z Profile
- Byte 14: Drive CPU1 Major version
- Byte 15: Drive CPU1 Minor version
- Byte 16: PDP003Z software version
- Byte 17: PDP003Z communication network Fault
- Byte 18: PDP003Z internal link Fault

* It is necessary to set the parameter [10] to "4".

* It is necessary to set it by the configuration to include Byte 7 or more in the response.
(The figure below is a setting for SIMATEC Step7.)

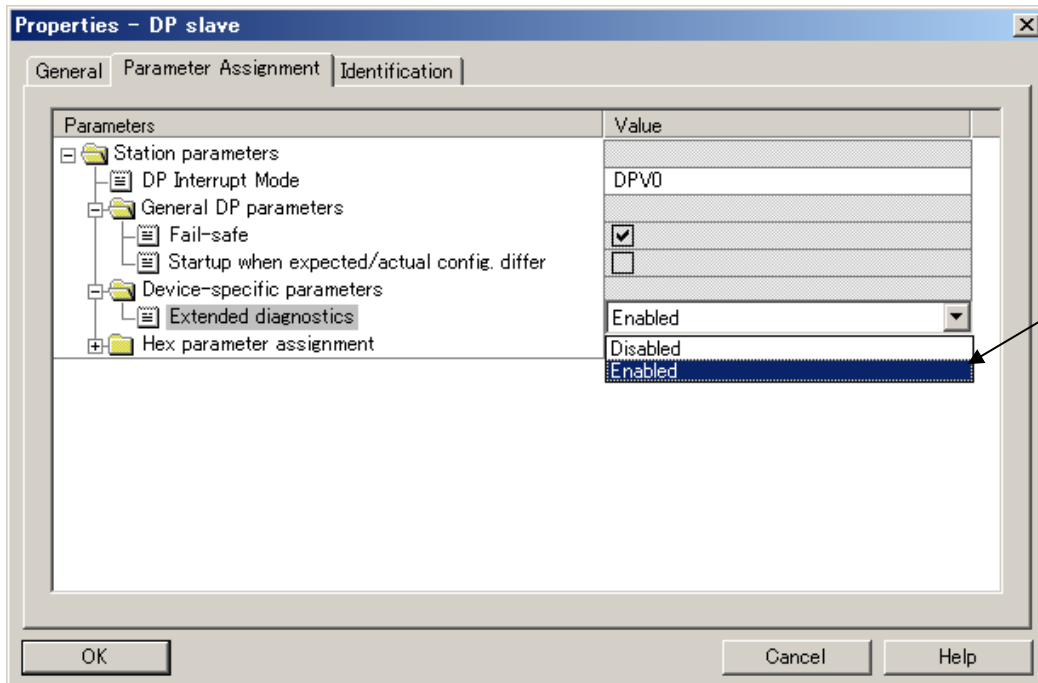

6. DP-V1 function

DP-V1 acyclic communication is mainly used to read/write the parameter. VF-MB1 parameter and the PROFIBUS parameter can be read/written using PDP003Z.

The following setting is necessary in the configuration to communicate DP-V1.
(The figure below is a setting for SIMATEC Step7.)

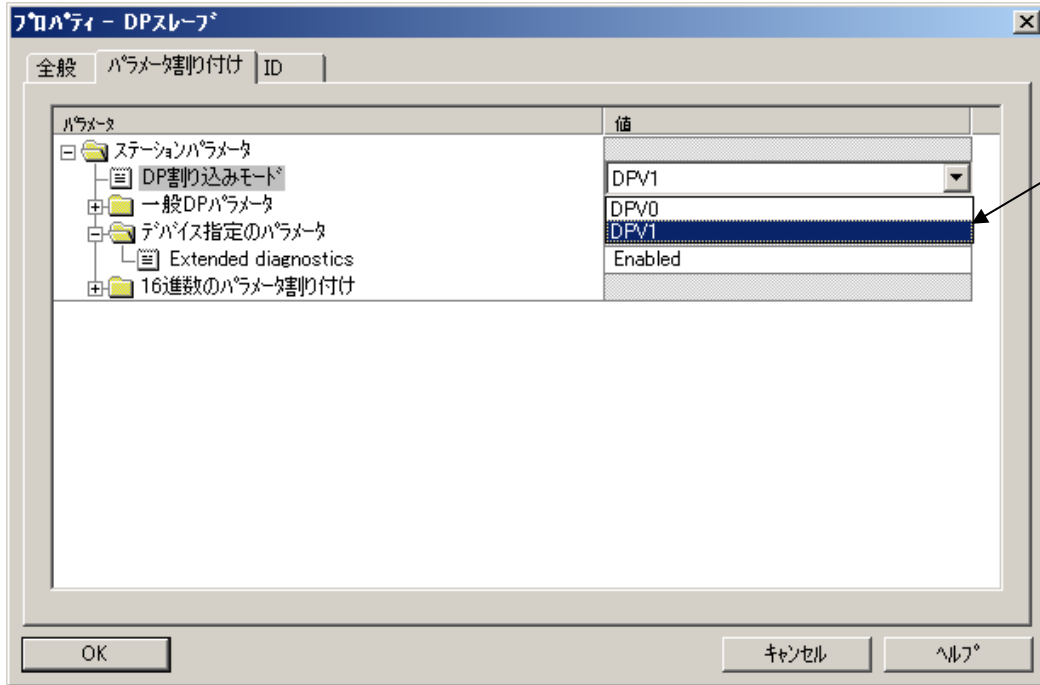

Parameter access sequence to VF-MB1 takes place as described in the following figure.

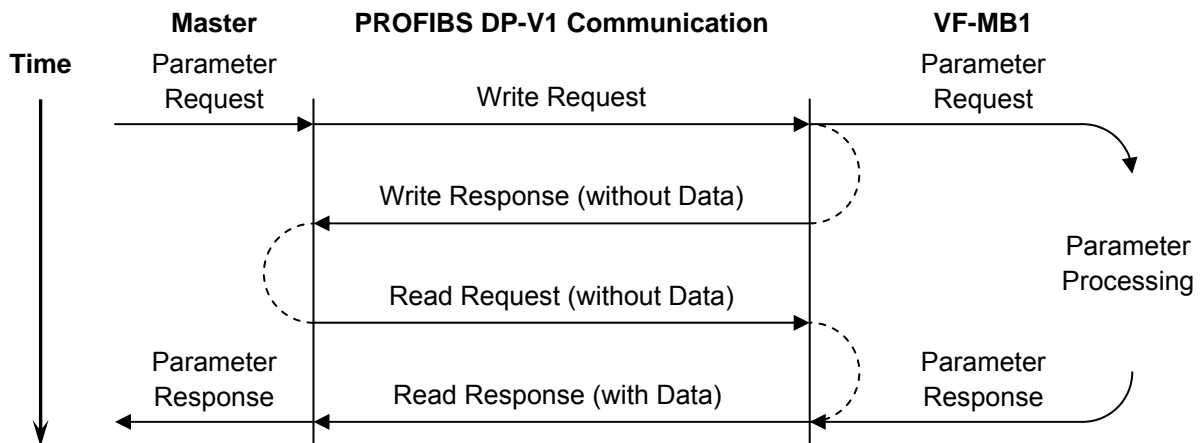

6.1. Example1. Read the PROFdrive parameter

6.1.1. Write Request data table (Read PNU 964 (0x03C4) IND 4)

Field	Description	Value
Header DU0	Function number	0x5F
Header DU1	Slot number (0)	0x00
Header DU2	Index (47)	0x2F
Header DU3	Length	0x0E
Request Header (Byte 1)	Request Reference	0x01
Request Header (Byte 2)	Request ID (0x01: Request)	0x01
Request Header (Byte 3)	Axis	0x01
Request Header (Byte 4)	Number of Parameters	0x01
Parameter Address (Byte 1)	Attribute (0x10: Value)	0x10
Parameter Address (Byte 2)	Number of Elements	0x01
Parameter Address (Byte 3)	Parameter number (PNU), High byte	0x03
Parameter Address (Byte 4)	Parameter number (PNU), Low byte	0xC4
Parameter Address (Byte 5)	Subindex (IND), High byte	0x00
Parameter Address (Byte 6)	Subindex (IND), Low byte	0x04

6.1.2. Read Response data table (positive)

Field	Description	Value
Header DU0	Function number	0x5E
Header DU1	Slot number (0)	0x00
Header DU2	Index (47)	0x2F
Header DU3	Length	0x08
Request Header (Byte 1)	Request Reference (mirrored)	0x01
Request Header (Byte 2)	Response ID *	0x01
Request Header (Byte 3)	Axis (mirrored)	0x01
Request Header (Byte 4)	Number of Parameters	0x01
Parameter Value (Byte 1)	Format *	0x06
Parameter Value (Byte 2)	Number of Values	0x01
Parameter Value (Byte 3)	Values, High byte	0x0A **
Parameter Value (Byte 4)	Values, Low byte	0x90 **

* Refer to Appendix.

** Value 0x0A90 is "2704" in decimal. This means "April 27".

6.2. Example 2. Change the PROFdrive parameter

6.2.1. Write Request data table (Change, set 0 to PNU 927 (0x039F))

Field	Description	Value
Header (DU0)	Function number	0x5F
Header (DU1)	Slot number (0)	0x00
Header (DU2)	Index (47)	0x2F
Header (DU3)	Length	0x0E
Request Header (Byte 1)	Request Reference	0x01
Request Header (Byte 2)	Request ID (0x02: Change) *	0x02
Request Header (Byte 3)	Axis	0x01
Request Header (Byte 4)	Number of Parameters	0x01
Parameter Address (Byte 1)	Attribute	0x10
Parameter Address (Byte 2)	Number of Elements	0x01
Parameter Address (Byte 3)	Parameter number (PNU), High byte	0x03
Parameter Address (Byte 4)	Parameter number (PNU), Low byte	0x9F
Parameter Address (Byte 5)	Subindex (IND), High byte	0x00
Parameter Address (Byte 6)	Subindex (IND), Low byte	0x00
Parameter Value (Byte 1)	Format *	0x06
Parameter Value (Byte 2)	Number of Value	0x01
Parameter Value (Byte 3)	Values, High byte	0x00
Parameter Value (Byte 4)	Values, Low byte	0x00

* Refer to Appendix.

Read Response data table (positive)

Field	Description	Value
Header DU0	Function number	0x5E
Header DU1	Slot number (0)	0x00
Header DU2	Index (47)	0x2F
Header DU3	Length	0x04
Request Header (Byte 1)	Request Reference (mirrored)	0x01
Request Header (Byte 2)	Response ID (0x02: Positive)	0x02
Request Header (Byte 3)	Axis (mirrored)	0x01
Request Header (Byte 4)	Number of Parameters	0x01

6.2.2. Read Response data table (negative, set 2 to PNU 927)

Field	Description	Value
Header DU0	Function number	0x5E
Header DU1	Slot number (0)	0x00
Header DU2	Index (47)	0x2F
Header DU3	Length	0x08
Request Header (Byte 1)	Request Reference (mirrored)	0x01
Request Header (Byte 2)	Response ID (0x82: Negative) *	0x82
Request Header (Byte 3)	Axis (mirrored)	0x01
Request Header (Byte 4)	Number of Parameters	0x01
Parameter Value (Byte 1)	Format (0x44: Error) *	0x44
Parameter Value (Byte 2)	Numner of Vlaues	0x01
Parameter Value (Byte 3)	Error number, High byte	0x00
Parameter Value (Byte 4)	Error number, Low byte	0x01

* Refer to Appendix.

6.3. Example 3. Read the VF-MB1 parameter

When access to VF-MB1 parameter, set "1000" to the PNU.

6.3.1. Write Request data table (Read F_{d04} (Input voltage))

Field	Description	Value
Header DU0	Function number	0x5F
Header DU1	Slot number (0)	0x00
Header DU2	Index (47)	0x2F
Header DU3	Length	0x0A
Request Header (Byte 1)	Request Reference	0x01
Request Header (Byte 2)	Request ID (0x01: Request) *	0x01
Request Header (Byte 3)	Axis	0x01
Request Header (Byte 4)	Number of Parameters	0x01
Parameter Address (Byte 1)	Attribute	0x10
Parameter Address (Byte 2)	Number of Elements	0x01
Parameter Address (Byte 3)	Parameter number, High byte **	0x03
Parameter Address (Byte 4)	Parameter number, Low byte **	0xE8
Parameter Address (Byte 5)	VF-MB1 Parameter number, High byte	0xFD
Parameter Address (Byte 6)	VF-MB1 Parameter number, Low byte	0x04

* Refer to Appendix.

** Parameter number is fixed to 0x03E8 (1000) for accessing to VF-MB1 parameter.

6.3.2. Read Response data table (positive)

Field	Description	Value
Header DU0	Function number	0x5E
Header DU1	Slot number (0)	0x00
Header DU2	Index (47)	0x2F
Header DU3	Length	0x08
Request Header (Byte 1)	Request Reference (mirrored)	0x01
Request Header (Byte 2)	Response ID *	0x01
Request Header (Byte 3)	Axis (mirrored)	0x01
Request Header (Byte 4)	Number of Parameters	0x01
Parameter Value (Byte 1)	Format *	0x42
Parameter Value (Byte 2)	Number of Values	0x01
Parameter Value (Byte 3)	Values, High byte	0x31 **
Parameter Value (Byte 4)	Values, High byte	0xEC **

* Refer to Appendix.

** Value 0x31EC is "12780" in decimal. This means "128.80 (%)".

6.4. Example 4. Change the VF-MB1 parameter

When access to VF-MB1 parameter, set "1000" to the PNU.

* This procedure changes the value of VF-MB1 EEPROM.

6.4.1. Write Request data table (Change, set 7 to VF-MB1 parameter *F 130*)

Field	Description	Value
Header DU0	Function number	0x5F
Header DU1	Slot number (0)	0x00
Header DU2	Index (47)	0x2F
Header DU3	Length	0x0E
Request Header (Byte 1)	Request Reference	0x01
Request Header (Byte 2)	Request ID (0x02: Change) *	0x02
Request Header (Byte 3)	Axis	0x01
Request Header (Byte 4)	Number of Parameters	0x01
Parameter Address (Byte 1)	Attribute	0x10
Parameter Address (Byte 2)	Number of Elements	0x01
Parameter Address (Byte 3)	Parameter number, High byte **	0x03
Parameter Address (Byte 4)	Parameter number, Low byte **	0xE8
Parameter Address (Byte 5)	VF-MB1 Parameter number, High byte	0x01
Parameter Address (Byte 6)	VF-MB1 Parameter number, Low byte	0x30
Parameter Value (Byte 1)	Format **	0x42
Parameter Value (Byte 2)	Number of Value	0x01
Parameter Value (Byte 3)	Value, High byte	0x00
Parameter Value (Byte 4)	Value, Low byte	0x07

* Refer to Appendix.

** Parameter number is fixed to 0x03E8 (1000) for accessing to VF-MB1 parameter.

6.4.2. Read Response data table (positive)

Field	Description	Value
Header DU0	Function number	0x5E
Header DU1	Slot number (0)	0x00
Header DU2	Index (47)	0x2F
Header DU3	Length	0x04
Request Header (Byte 1)	Request Reference (mirrored)	0x01
Request Header (Byte 2)	Response ID *	0x02
Request Header (Byte 3)	Axis (mirrored)	0x01
Request Header (Byte 4)	Number of Parameters	0x01

* Refer to Appendix.

6.4.3. Read Response data table (negative, at set 256 to *F 130*)

Field	Description	Value
Header DU0	Function number	0x5E
Header DU1	Slot number (0)	0x00
Header DU2	Index (47)	0x2F
Header DU3	Length	0x08
Request Header (Byte 1)	Request Reference (mirrored)	0x01
Request Header (Byte 2)	Response ID *	0x82
Request Header (Byte 3)	Axis (mirrored)	0x01
Request Header (Byte 4)	Number of Parameters	0x01
Parameter Value (Byte 1)	Format * (= Error)	0x44
Parameter Value (Byte 2)	Numner of Vlaues	0x01
Parameter Value (Byte 3)	Error number, High byte *	0x00
Parameter Value (Byte 4)	Error number, Low byte *	0x02

* Refer to Appendix.

PROFIBUS Local/Remote Operation

The example below shows how to configure the VF-MB1 for local / remote operation.

<Terminal function>

- F terminal RUN command
- R terminal..... PROFIBUS/Local (Terminal in this example) switching
- VIB terminal Operation frequency command

<Wiring>

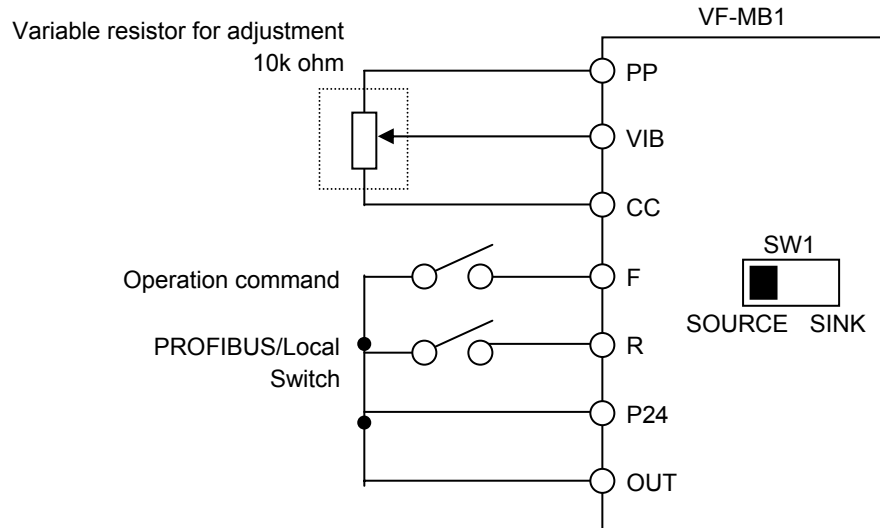

<Parameter setting>

- $C00d$ (command mode selection) = 0 (terminal board)
- $F00d$ (frequency setting mode selection 1) = 2 (VIB)
- $F112$ (input terminal selection 2 (R)) = 48 (PROFIBUS/Local control)

<Operation>

- R-CC terminal open:
VF-MB1 is controlled as slave device of PROFIBUS.
- R-CC terminal closed:
F-CC terminal short to RUN
F-CC terminal open to STOP
Output frequency is set up by the VIB signal input.

7. GSD file

As for acquisition of an GSD file, it is possible to download from homepage of our company.

Please use what was in agreement with the software version of usage's VF-MB1.

<http://www.inverter.co.jp/product/inv/vfmb1/pdp/>

8. Appendix

Function number

0x5E: Read Request
0x5F: Write Request
0x5E: Positive response for Read request
0x5F: Positive response for Write request
0xDE: Negative response for Read request
0xDF: Negative response for Write request

Request ID

0x01: Request the value
0x02: Change the value

Response ID

0x01: Positive response for Request the value
0x02: Positive response for Change the value
0x81: Negative response for Request the value
0x82: Negative response for Change the value

Axis

0x00: (Fixed for PDP003Z)

Error number

0x00: Impermissible parameter number
0x01: Impermissible parameter number
0x02: Low or High limit exceeded
0x03: Faulty subindex
0x04: No array
0x05: Incorrect data type
0x06: Setting not permitted (may only be reset)
0x07: Description element cannot be changed
0x09: No description data available
0x0B: No operation priority
0x0F: No text array available
0x11: Request cannot be executed because of operating state
0x14: Value impermissible
0x15: Response too long
0x17: Write Req., Illegal format/format of the parameter data is not supported
0x18: Number of values are not consistent
0x19: Axis/DO non existent
0x20: Parameter text element cannot be changed

Format

0x01: Boolean
0x02: Integer 8
0x03: Integer 16
0x04: Integer 32
0x05: Unsigned 8
0x06: Unsigned 16
0x07: Unsigned 32
0x08: FloatingPoint
0x09: VisibleString
0x10: OctetString
0x12: TimeOfDay (with date indication)
0x13: TimeDifference
0x40: Zero
0x41: Byte
0x42: Word
0x43: Double word
0x44: Error