

TOSVERT VF-MB1/S15

PROFIBUS-DP Option Function Manual

PDP003Z

NOTICE

1. Read this manual before installing or operating. Keep this instruction manual on hand of the end user, and make use of this manual in maintenance and inspection.
2. All information contained in this manual will be changed without notice. Please contact your Toshiba distributor to confirm the latest information.

Contents

1. Introduction	1
2. Connection Information.....	6
2.1. Exterior features.....	6
2.2. Status indicator	7
2.3. VF-MB1/S15 Communication parameters	8
3. Profile.....	9
3.1. Telegram	9
3.2. STW Control Word Data	10
3.3. ZSW Status Word Data.....	11
3.4. State Machine	13
3.5. Access to the PROFIBUS parameter	15
3.6. PROFIBUS parameter (PNU)	16
3.7. Access to VF-MB1/S15 parameter	18
4. Vendor Spec. Profile.....	20
4.1. How to use	21
4.2. The overview of the VF-MB1/S15 parameter	22
5. Diagnostic	29
6. DP-V1 function.....	30
6.1. Example 1. Read the PROFIdrive parameter	31
6.2. Example 2. Change the PROFIdrive parameter	32
6.3. Example 3. Read the VF-MB1/S15 parameter	33
6.4. Example 4. Change the VF-MB1/S15 parameter	34
7. PROFIBUS Local/Remote Operation	35
8. GSD file.....	35
9. Appendix.....	36

1. Introduction

Thank you for purchasing the PROFIBUS-DP option “PDP003Z” for the VF-MB1/S15. Before using the PROFIBUS-DP option, please familiarize yourself with the product and be sure to thoroughly read the instructions and precautions contained in this manual. This option needs the option adaptor to connect VF-S15 which type form is SBP009Z. Please match here and buy it when SBP009Z is not at hand yet.

In addition, please make sure that this manual and “Installation Manual” is delivered to the customer, and keep this function manual in a safe place for future reference or drive/interface inspection.

This manual describes the supported functions for the “PDP003Z”.



In conjunction with this manual, the following manuals are supplied by Toshiba, and they are essential both for ensuring a safe, reliable system installation as well as for realizing the full potential of the “PDP003Z”:

- TOSVERT VF-MB1 Instruction Manual.....E6581697
- TOSVERT VF-S15 Instruction Manual.....E6581611
- TOSVERT VF-MB1/S15 communication option Precautions Manual· E6581739

Safety precautions

On the drive and in its instruction manual, important information is contained for preventing injuries to users and damages to assets and for proper use of the device. Read the instruction manual attached to VF-MB1/S15 along with this instruction manual for completely understanding the safety precautions and adhere to the contents of these manuals.



Explanation of markings

Marking	Meaning of marking
 Warning	Indicates that errors in operation may lead to death or serious injury.
 Caution	Indicates that errors in operation may lead to injury (*1) to people or that these errors may cause damage to physical property. (*2)



(*1) Such things as injury, burns or shock that will not require hospitalization or long periods of outpatient treatment.

(*2) Physical property damage refers to wide-ranging damage to assets and materials.



Meanings of symbols

Marking	Meaning of marking
	Indicates prohibition (Don't do it). What is prohibited will be described in or near the symbol in either text or picture form.
	Indicates something mandatory (must be done). What is mandatory will be described in or near the symbol in either text or picture form.
	Indicates warning. What is warned will be described in or near the symbol in either text or picture form. Indicates caution. What the caution should be applied to will be described in or near the symbol in either text or picture form.

■ General Operation

⚠ Warning	
 Disassembly prohibited	<ul style="list-style-type: none"> ▼ Never disassemble, modify or repair. Doing so could result in electric shock, fire and injury. For repairs, call your sales agency.
 Prohibited	<ul style="list-style-type: none"> ▼ Do not attach this option to any drive other than the VF- MB1/S15. Doing so could result in electric shock or fire. ▼ When the drive is energized, never detach the this option from the VF- MB1/S15. Doing so could result in electric shock. ▼ Don't place or insert any kind of object into the PDP003Z (electrical wire cuttings, rods, wires). Doing so could result in electric shock or fire. ▼ Do not allow water or any other fluid to come in contact with the PDP003Z. Doing so could result in electric shock or fire.
 Mandatory	<ul style="list-style-type: none"> ▼ Turn off the VF- MB1/S15 when installing and wiring this option. ▼ If the drive begins to emit smoke or an unusual odor, or unusual sounds, immediately turn power off. If the equipment is continued in operation in such a state, the result may be fire. Call your local sales agency for repairs.

■ Transportation & installation

⚠ Warning	
 Prohibited	<ul style="list-style-type: none"> ▼ Do not operate the drive if it is damaged or any component is missing. Doing so could result in electric shock or fire. Call your local sales agency for repairs. ▼ Do not place any inflammable substances near the VF- MB1/S15 drive. If an accident occurs in which flame is emitted, this could lead to fire. ▼ Do not install in any location where the drive could come into contact with water or other fluids. Doing so could result in electric shock or fire. ▼ When installing this option, be careful not to touch the leads from parts on the reverse side of its circuit board. Doing so could result in injury.
 Mandatory	<ul style="list-style-type: none"> ▼ Operate under the environmental conditions prescribed in the instruction manual. Operations under any other conditions may result in malfunction.



■ Wiring

⚠ Warning	
 Mandatory	<ul style="list-style-type: none"> ▼ Shut off power when installing and wiring this option. Wait at least 15 minutes and check to make sure that the charge lamp (VF- MB1/S15) is no longer lit. ▼ Electrical construction work must be done by a qualified expert. Installation or connection of input power by someone who does not have that expert knowledge may result in fire or electric shock.

■ Operations

⚠ Warning	
 Prohibited	<ul style="list-style-type: none"> ▼ Do not touch switches when the hands are wet and do not try to clean the drive with a damp cloth. Doing so could result in electric shock. ▼ Do not pull on any cable it self. Doing so could result in damage or malfunction.

■ Cautions for the communication

⚠ Warning	
 Prohibited	<ul style="list-style-type: none"> ▼ Do not set the value that exceeds an effective range as data. The motor may suddenly restart or stop and that could result in injury.
 Mandatory	<ul style="list-style-type: none"> ▼ Check PROFIBUS state (using below status word bit) when the option unit is deactivated by an unusual event such as an operating error, power outage, failure, etc. - ZSW Status Word Bit 3 (Fault), Bt 7 (Warning) (The communication error occurs when "1" as value or this value cannot be read.) Deactivated option unit may cause an accident, if the PROFIBUS state is not checked. ▼ Make sure that the operation signals are STOP before clearing the drive's fault. The motor may suddenly start and that may result in injuries.

■ Disposal

⚠ Caution	
 Mandatory	<ul style="list-style-type: none"> ▼ For safety's sake, do not dispose of the disused drive yourself but ask an industrial waste disposal agent (*). If the collection, transport and disposal of industrial waste is done by someone who is not licensed for that job, it is a punishable violation of the law. (Laws in regard to cleaning and processing of waste materials) (*) Persons who specialize in the processing of waste and known as "industrial waste product collectors and transporters" or "industrial waste disposal persons."

Notes on use

Notes

- ▼ Do not install the drive where the temperature or the humidity will change rapidly.
- ▼ Keep a distance of 20cm or more between the drive 's power cable and the data transmission cable.
Or the drive might malfunction because of noise.
- ▼ Insert a magnetic contactor or similar device between the drive and the power supply to ensure that power is turned off if an emergency stop command is entered through the network.

2. Connection Information

This option allows the VF-MB1/S15 drive to be communicated with the cyclic command transmission and monitoring of the original profile ("Vendor spec.", refer to Section 4) of our company other than application profile "Profile for Variable Speed Drives PROFIdrive (3.072), refer to Section 3" which PROFIBUS defines.

When you use VF-MB1, the shielding is connected to the drive ground. When you use VF-S15, the shielding is connected to the grounding terminal of option adapter.

2.1. Exterior features

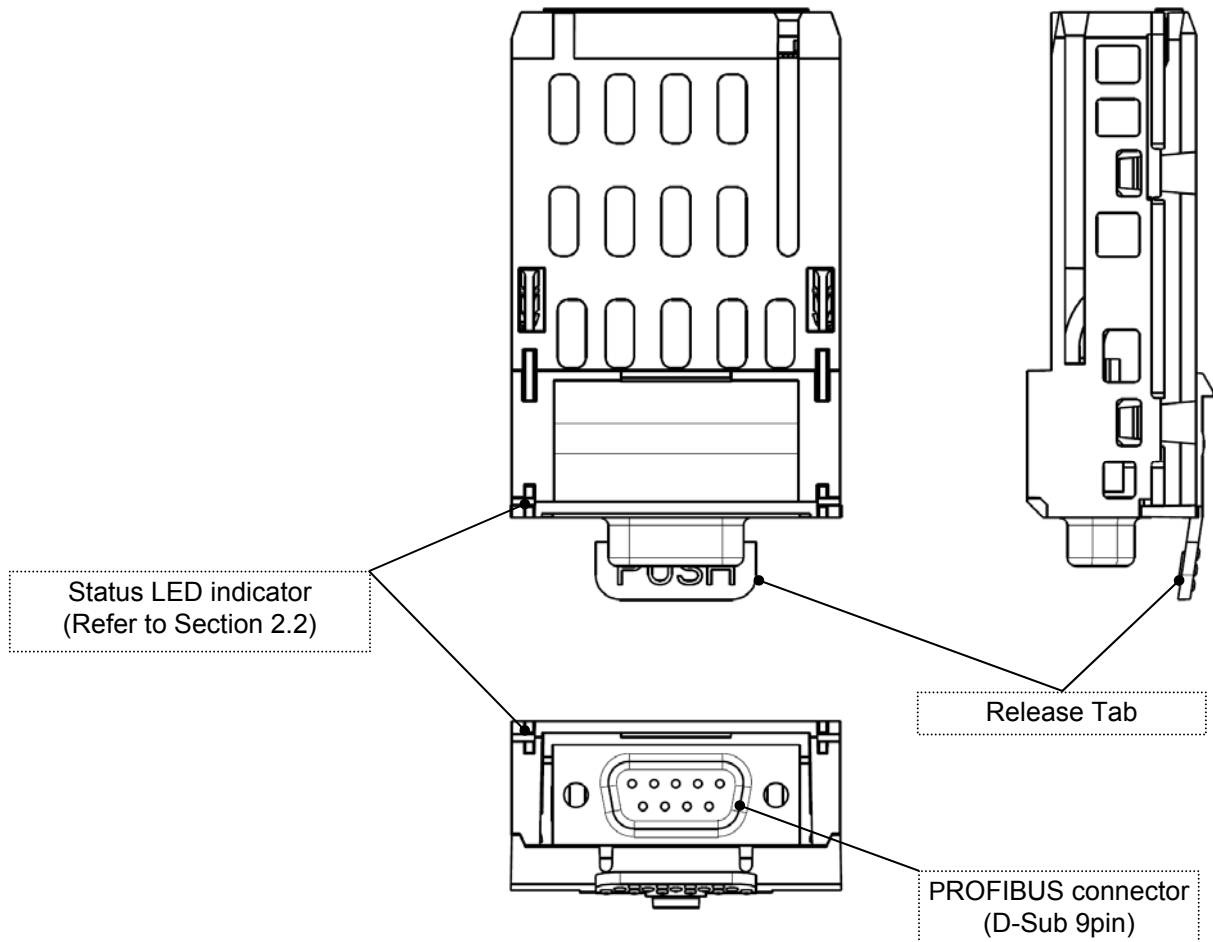

To align VF-MB1/S15 side-by-side horizontally, "Vertical" type PROFIBUS connector is necessary.

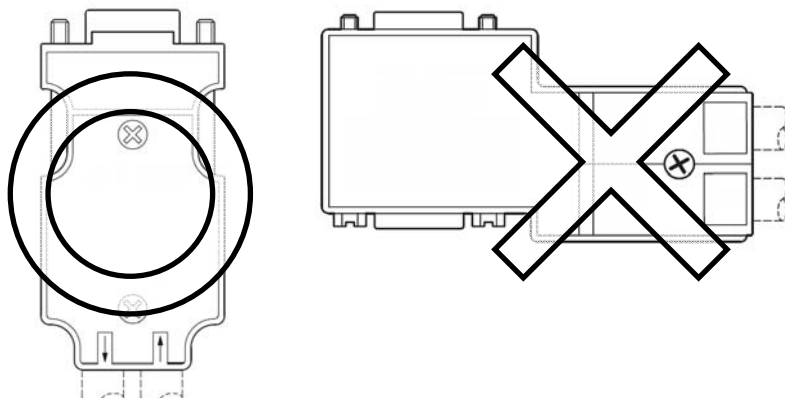

2.2. Status indicator

The PDP003Z has two LEDs, ST (status) and DX (data exchange) to indicate the statuses of PROFIBUS-DP and the PDP003Z itself.

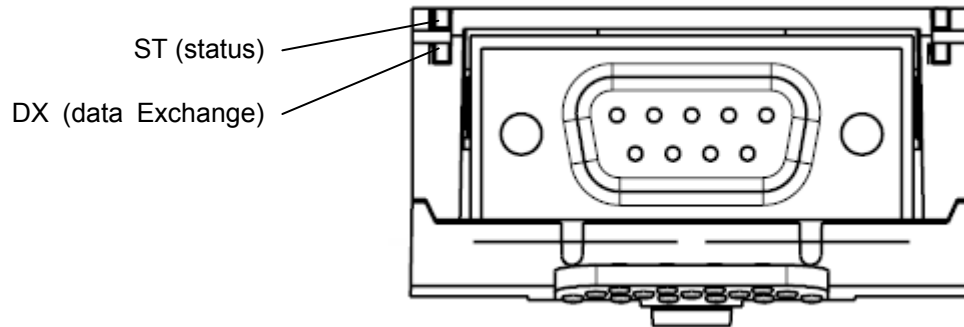

ST (Status): Red LED

LED	Meanings
Off	No diagnostics present
Flashes	8 Hz (Blinking 4 times/1sec.): Waiting for parameterization or configuration
	2 Hz (Blinking 1 times/1sec.): PDP003Z station address is "126". (Refer to 2.3 section .)
Lights	DP status error * For example, a station address is not set correctly.

DX (Data exchange): Green LED.

Indicates the status of the PROFIBUS network.

It lights when the PDP003Z is on-line and data exchange is possible.

2.3. VF-MB1/S15 Communication parameters

In a network, VF-MB1/S15 (PDP003Z) serves as a PROFIBUS slave device. PDP003Z configuration is set by the following parameters.

Parameter	Function	Adjustment range	Default setting
$\zeta 150$	PDP003Z Station address	2 to 126 The station address "126" cannot exchange data.	126
$\zeta 151$	PDP003Z Baud rate Monitor	0: 12 Mbit/s 1: 6 Mbit/s 2: 3 Mbit/s 3: 1.5 Mbit/s 4: 500 kbit/s 5: 187.5 kbit/s 6: 93.75 kbit/s 7: 19.2 kbit/s 8: 9.6 kbit/s	-
$\zeta 152$	PDP003Z Profile Monitor	0 : Telegram 1 (PROFdrive) 1 : Telegram 100 (Vender Spec. 1) 2 : Telegram 101 (Vender Spec. 2) 3 : Telegram 102 (Vender Spec. 3)	-
$\zeta 154$	JOG1 Frequency (STW.8)	0.0 to 20.0Hz	5.0Hz
$\zeta 155$	JOG2 Frequency (STW.9)	0.0 to 20.0Hz	5.0Hz
$\zeta 156$	Tmax (ZSW.8)	0.1 to 60.0s	10.0s
$\zeta 157$	Tolerance (ZSW.8)	0.1 to 99.0%	50.0%
$\zeta 100$	Communication error detection delay time	0.0 to 100.0 sec	0.0
$\zeta 101$	Drive operation at the communications loss action (Network wire breaks)	0: Stop and Communication release * (follows $\zeta n0d$ and $F n0d$ setting) 1: None 2: Deceleration stop 3: Coast stop 4: Emergency stop 5: Preset speed operation command (Operating at the preset speed operation frequency set with $\zeta 102$)	4
$\zeta 102$	Preset speed operation selection	0: None 1 to 15: Preset speed ($5r 1 - 5r 7, F287 - F295$)	0
$\zeta 103^{**}$	Communication time-out condition selection	0: Disconnection detection 1: When communication mode enable (Both $\zeta n0d$ and $F n0d$ are set CANopen or COM option) 2: 1+Driving operation	1
$F899$	Network option reset setting	0: None 1: Resetting the PDP003Z and the drive	0
$Fd67$	PDP003Z version	PDP003Z firmware version (ex. 0x1101 means "V1.01")	-

* Do not set at VF-MB1 **V1.00**.

** It is necessary to enable "Watchdog" function with the configurator.

*** When the parameters are changed or to reset $\zeta r r B$, the power must be cycled (or set $F899$ to 1).
After reset, the parameter changes become effective.

Set i to $F899$ by the PROFIBUS communication might not be able to be set.

**** When $F n0d$ or $\zeta n0d$ is set to "Communication option", VF-MB1/S15 drives without Net Reference (STW Bit 13) or Net Control (STW Bit 12) at PROFdrive.



Caution

Please note that drive keeps driving when the communication is lost if i (None) is set to the parameter $\zeta 101$ (Drive operation at the communications loss action).

3. Profile

3.1. Telegram

Telegram of PDP003Z is set up by the configurator.
 The figures below show the Telegrams and configurations that the PDP003Z supports.

PKW			PZD					
PKE	IND	PWE	PZD1 STW ZSW	PZD2 HSW HIW	PZD3	PZD4	PZD5	PZD6

Telegram 1: PROFIdrive (PPO TYPE 3, 2PZD)



Telegram 100: Vendor Spec. (PPO TYPE 1, 4PKW / 2PZD)



Telegram 101: Vendor Spec. (PPO TYPE 2, 4PKW / 6PZD)



Telegram 102: Vendor Spec. (PPO TYPE 4, 6 ZD)



- PKW: Parameter ID/value
- PZD: Process Data, cyclically transferred

- PKE: Parameter ID (1st and 2nd octet)
- IND: Sub-index (3rd octet), 4th octet is reserved
- PWE: Parameter value (5th until 8th octet)

- STW: Control word
- HSW: Main setpoint

- ZSW: Status word
- HIW: Main actual value

* There are some by which a high byte / low byte is conversely treated depending on a master.

3.2. STW Control Word Data

PDP003Z supports only speed control mode.

Bit	Value	Name	Note
0	1	ON	"Switched on" condition
	0	OFF	Normal stop.
1	1	No Coast Stop	All "Coast Stop (OFF2)" commands are withdrawn
	0	Coast Stop (OFF 2)	Coast stop.
2	1	No Quick Stop	All "Quick Stop (OFF3)" commands are withdrawn.
	0	Quick Stop (OFF 3)	Quick Stop
3	1	Enable Operation	The drive then runs-up to the setpoint.
	0	Disable Operation	Normal stop.
4	1	Enable Ramp Generator	-
	0	Reset Ramp Generator	Output of the RFG is set to 0.
5	1	Unfreeze Ramp Generator	-
	0	Freeze Ramp Generator	Freeze the actual setpoint entered by the RFG *.
6	1	Enable Setpoint	The value selected at the input of the RFG is switched-in.
	0	Disable Setpoint	The value selected at the input of the RFG is set to 0.
7	1	Fault Acknowledge	Fault reset (0 -> 1)
	0	No meaning	-
8	1	JOG 1 ON **	VF-MB1/S15 drives with JOG 1 speed 1 (㊦ 154).
	0	JOG 1 OFF	Jogging stop, if "JOG 1" was previously ON. Stop drive according to VF-MB1/S15 setting parameter.
9	1	JOG 2 ON **	VF-MB1/S15 drives with JOG 2 speed 2 (㊦ 155).
	0	JOG 2 OFF	Jogging stop, if "JOG 2" was previously ON. Stop drive according to VF-MB1/S15 setting parameter.
10	1	Control By PLC	The control word and main setpoint are activated.
	0	No Control By PLC	The control word and main setpoint are inactivated.
11	---	Device-specification	(Reserved.)
12	1	Net Control	PDP003Z control is enabled.
	0	Local Control	PDP003Z control is disabled.
13	1	Net Reference	PDP003Z reference is enabled.
	0	Local Reference	PDP003Z reference is disabled.
14	---	Device-specification	(Reserved.)
15	---	Device-specification	(Reserved.)

* RFG: Ramp Function Generator

** Operation is enabled, drive is in standstill and STW1 bit 4, 5, 6 = 0.

3.3. ZSW Status Word Data

Bit	Valure	Name	Note
0	1	Ready To Switch-on	Power supply is switched on
	0	Not Ready To Switch-on	-
1	1	Ready To Operate	Refer to control word, bit 1.
	0	Not Ready To Operate	-
2	1	Operation Enabled	Drive follows setpoint. (Refer to control word 1, bit 3)
	0	Operation Disabled	-
3	1	Fault Present	VF-MB1/S15 tripped.
	0	No Fault	VF-MB1/S15 is not tripped.
4	1	Coast Stop Not Activated	-
	0	Coast Stop Activated (OFF 2)	"Coast Stop (OFF 2)" command is present.
5	1	Quick Stop Not Activated	-
	0	Quick Stop Activated (OFF 3)	"Quick Stop (OFF 3)" command is present
6	1	Switching On Inhibited	Control word bit1 or 2 is set to 0 or fault trip has been acknowledged.
	0	Switching On Not Inhibited	-
7	1	Warning Present	Drive still operational: Alarm in service parameter: No acknowledgement.
	0	No Warning	Alarm not present or alarm has disappeared again
8	1	Speed Error Within Tolerance Range	Refer to section 3.3.1.
	0	Speed Error Out Of Tolerance Range	
9	1	Control Requested	VF-MB1/S15 is controlled by PROFIBUS master.
	0	No Control Requested	VF-MB1/S15 is controlled by another interface.
10	1	f Or n Reached Or Exceeded	Actual value \geq Comparison value (setpoint)
	0	f Or n Not Reached	-
11	----	Device-specification	(Reserved.)
12	----	Device-specification	(Reserved.)
13	----	Device-specification	(Reserved.)
14	----	Device-specification	(Reserved.)
15	----	Device-specification	(Reserved.)

3.3.1. Tolerance Range (ZSW Bit 8)

If the setpoint is changed:

1. ZSW Bit 8 is set 0
2. Calculate the tolerance.
3. Start the timer which will time-out based on parameter Tmax.

PDP003Z checks that the timer (Tmax) has not timed-out and if the actual value is within the tolerance. If both conditions are fulfilled ZSW Bit 8 is set 1 and the timer is stopped.

The figure shows ZSW 8 when Tolerance (L 15 7) is 50% and Tmax (L 15 1) is 3s.

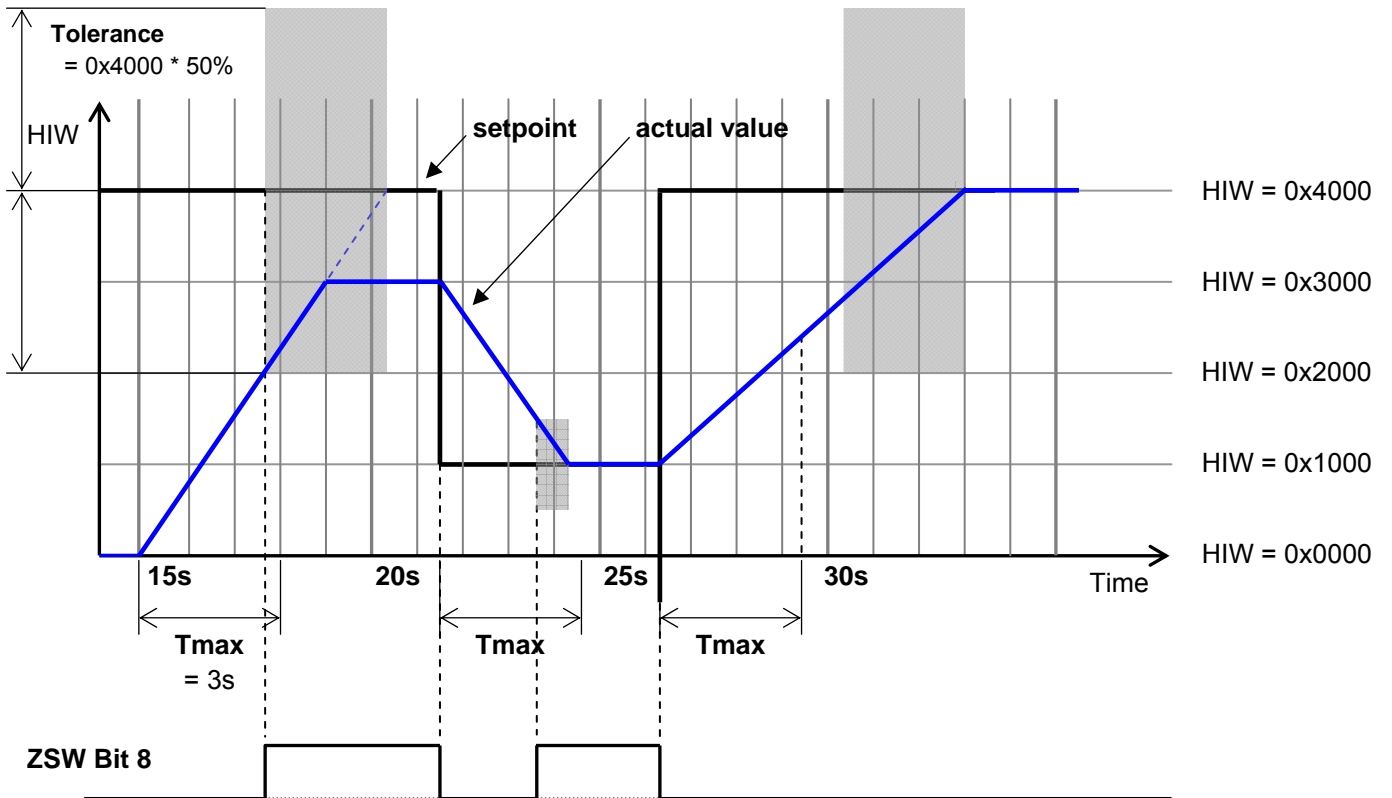

3.4. State Machine

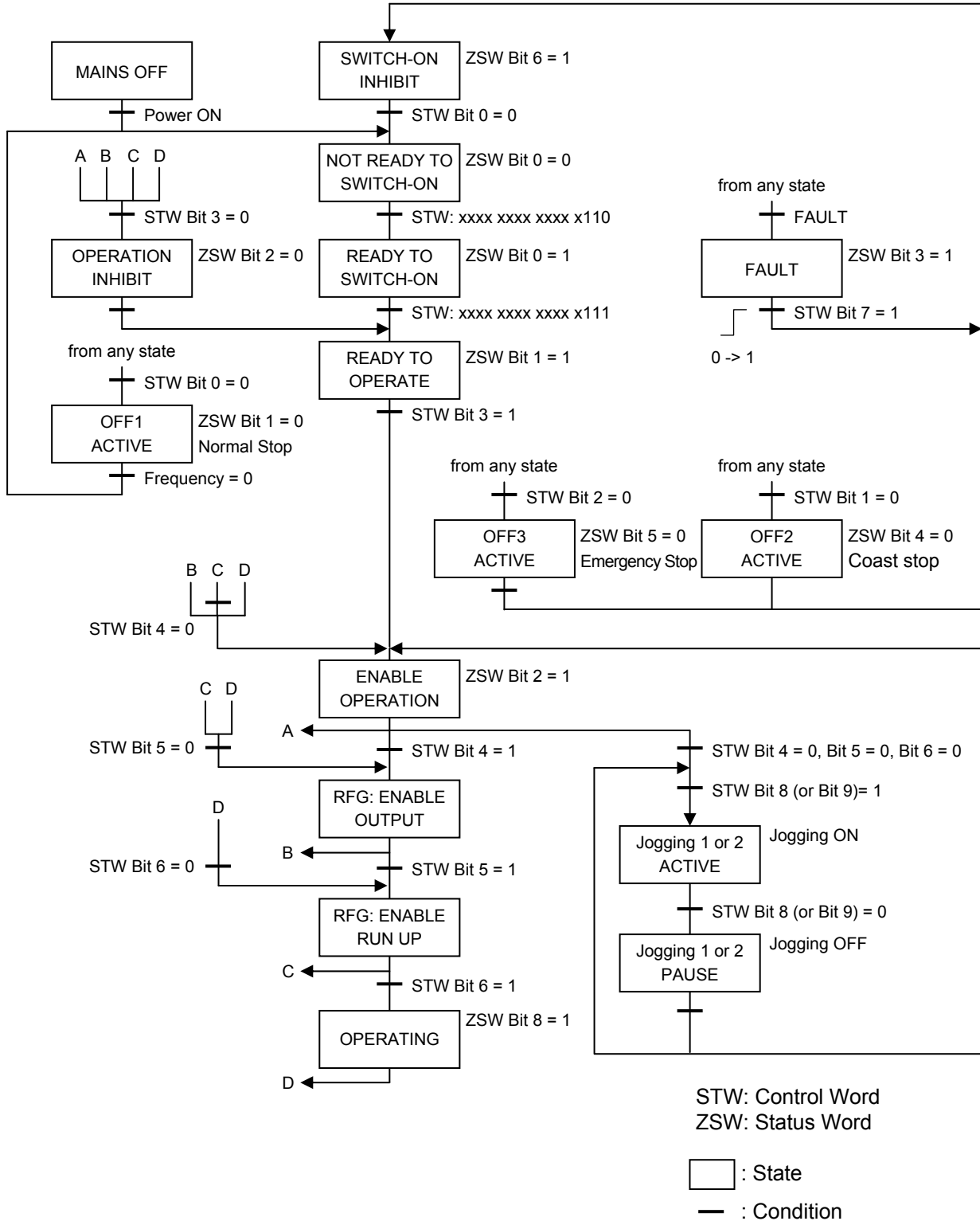

Notes	
	<ul style="list-style-type: none"> ▼ STW Bit 10, 12 = 1 or $\overline{L} \overline{N} \overline{D} = 4$ is needed for above control. ▼ If $\overline{L} \overline{N} \overline{D}$ is set to Local (0, 1, 2 or 3), set 1 to STW Bit10 and 12 first after turning on the power supply of VF-MB1/S15. ▼ Check ZSW always and take care to give the command to STW.

3.4.1. Examples of driving by the State Machine

When using the PROFIdrive profile, the frequency reference is set to HSW. The setting value "0x0000" - "0x4000" is equivalent to "0" - "Base frequency (parameter FH)".
 When the reverse operation, the frequency reference is set with two's complement of the forward frequency reference. During running, HIW shows a output frequency.
 * F_{ref} or ζ_{ref} is set to "Communication option" on these examples.

3.4.1.1. Example 1. 60Hz Forward running and Deceleration stop

Set "0x4000" to HSW and the following is set to STW in order.

```

① 0000 0100 0000 0110 (= 0x0406)
   ↓
   "READY TO SWITCH-ON"
   ↓
② 0000 0100 0000 0111 (= 0x0407)
   ↓
   "READY TO OPERATE"
   ↓
③ 0000 0100 0111 1111 (= 0x047F)
   ↓
   "OPERATION"
   ↓
④ 0000 0100 0111 1110 (= 0x047E)
   ↓
   "OFF1 ACTIVE (Normal Stop)"
  
```

3.4.1.2. Example 2. 30Hz Reverse running

When the reverse operation, "0xE000" is set to HSW. "0xE000" is two's complement of the "0x2000" as the forward frequency reference 30Hz.
 The Setup to STW is same as the Example 1.

3.4.1.3. Example 3. Inching and pause

the following is set to STW in order.

```

① 0000 0100 0000 0110 (= 0x0406)
   ↓
   "READY TO SWITCH-ON"
   ↓
② 0000 0100 0000 0111 (= 0x0407)
   ↓
   "READY TO OPERATE"
   ↓
③ 0000 0101 0000 1111 (= 0x050F)
   ↓
   "Jogging 1 ACTIVE"
   ↓
④ 0000 0100 0100 1111 (= 0x040F)
   ↓
   "Jogging 1 PAUSE"
  
```

* The inching frequency is according to the parameter ζ_{154} , ζ_{155} on VF-MB1/S15.

3.5. Access to the PROFIBUS parameter

In the cyclic PROFIBUS-DP communication, the parameter data is transferred via Telegram 100, 101. If the requirement is not executed, the cause is distinguished by octet 7 and 8.

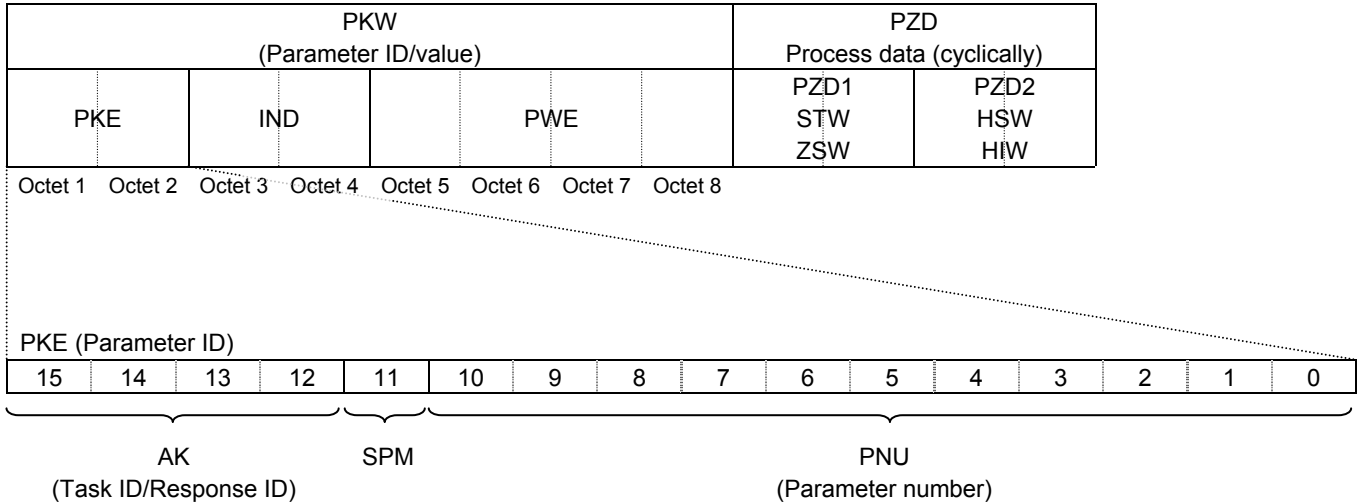

AK (Request from Master to PDP003Z)

Request ID	Function	Note
0	No task	
1	Request parameter value	for PNU access
2	Change parameter value (word)	for PNU access
6	Request parameter value (array)	for PNU access, VF-MB1/S15 parameter access
7	Change parameter value (array)	for PNU access, VF-MB1/S15 parameter access

AK (Response from PDP003Z to Master)

Response ID	Function
0	No response
1	Transfer parameter value (word)
4	Transfer parameter value (array)
7	Task can not be executed, followed by error number 0 = Illegal parameter number 1 = Parameter value cannot be changed 2 = Lower or upper limit violated 3 = Erroneous sub index 11 = No parameter change rights 17 = Task cannot be executed due to operating status (e.g. parameter is currently read-only) 18 = Other error 102 = Request not supported

SPM: always 0.

3.6. PROFIBUS parameter (PNU)

PNU	R/W	data type	Note
915	R	Array [6] Unsigned16	PNU 915, IND 0 = the drive parameter $\llcorner 001$ PNU 915, IND 1 = the drive parameter $\llcorner 002$ PNU 915, IND 2 = the drive parameter $\llcorner 003$ PNU 915, IND 3 = the drive parameter $\llcorner 004$ PNU 915, IND 4 = the drive parameter $\llcorner 005$ PNU 915, IND 5 = the drive parameter $\llcorner 006$
916	R	Array [6] Unsigned16	PNU 916, IND 0 = the drive parameter $\llcorner 021$ PNU 916, IND 1 = the drive parameter $\llcorner 022$ PNU 916, IND 2 = the drive parameter $\llcorner 023$ PNU 916, IND 3 = the drive parameter $\llcorner 024$ PNU 916, IND 4 = the drive parameter $\llcorner 025$ PNU 916, IND 5 = the drive parameter $\llcorner 026$
918	R	Unsigned16	Station address monitor (same as the drive parameter $\llcorner 150$).
922	R	Unsigned16	Telegram selection 1, 100, 101, 102
927	R/W	Unsigned16	Operator control rights (parameter identification, PKW). Value: Mode 0: Parameters cannot be written, only read (927 can be written). 1: Parameters can be written and read (default).
928	R	Unsigned16	Control rights (process data, PZD). 1: PZD part is enabled.
930	R	Unsigned16	Operating mode 1 : supports the speed control mode and the speed setpoint channel comprises RFG functionality.
944	R	Unsigned16	Fault message counter
947	R	Array [1] Unsigned16	Fault number
963	R	Unsigned16	Detected baud rate: 0 = 9.6 kbit/s 1 = 19.2 kbit/s 2 = 93.75 kbit/s 3 = 187.5 kbit/s 4 = 500 kbit/s 6 = 1.5 Mbit/s 7 = 3 Mbit/s 8 = 6 Mbit/s 9 = 12 Mbit/s
964	R	Array [5] Unsigned16	Drive Unit identification IND 0 = PDP003Z ID (0x0C24) IND 1 = Manufacturer-ID (0x0190) IND 2 = VF-MB1/S15 CPU1 version IND 3 = VF-MB1/S15 firmware release year (yyyy) IND 4 = VF-MB1/S15 firmware release date (ddmm)
965	R	Octet String2	Profile number of the PDP003Z (Profidrive, V4.1)

3.6.1. Examples of reading the PROFIdrive parameter

3.6.1.1. Example 1. Reading the PNU 922 (Telegram)

AK = 1 (Request parameter value)
 SPM = 0
 PNU = 922 (0x039A)

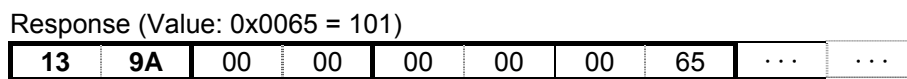
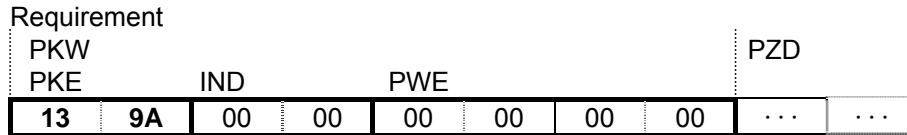
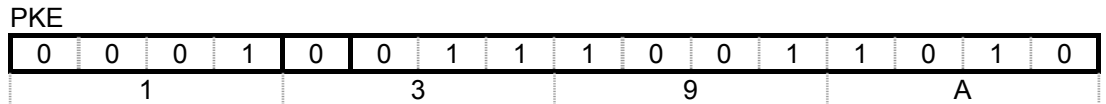

3.6.1.2. Example 2. Reading the PNU 964, IND 0

AK = 6 (Request parameter value (array))
 SPM = 0
 PNU = 964 (0x03C4)
 IND = 0 (PDP003Z ID)

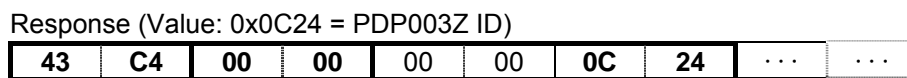
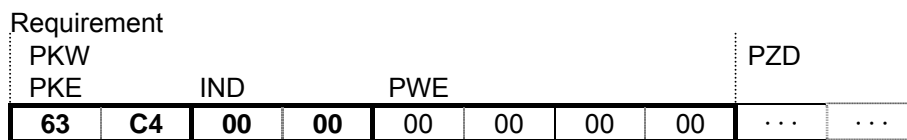
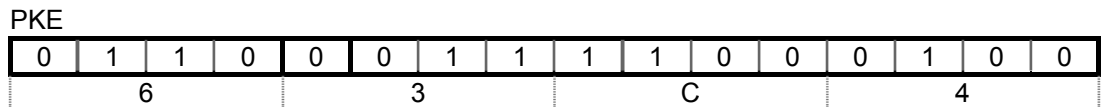

3.7. Access to VF-MB1/S15 parameter

When access to VF-MB1/S15 parameter, set "1" to the PNU. The communication number of the drive parameter is set to the subindex IND.

Refer to the drive instruction manual about the communication number and unit.

* This procedure changes the value of VF-MB1/S15 EEPROM.

3.7.1. Examples of reading or changing VF-MB1/S15 parameter

3.7.1.1. Example 1. Reading the basic parameter (CND (command mode selection))

AK = 6 (Request parameter value (array))
 SPM = 0
 PNU = 1
 IND = 0x0003 (CND communication number)

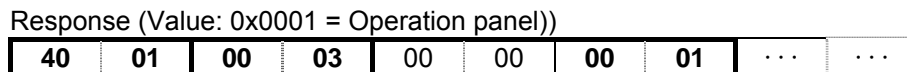
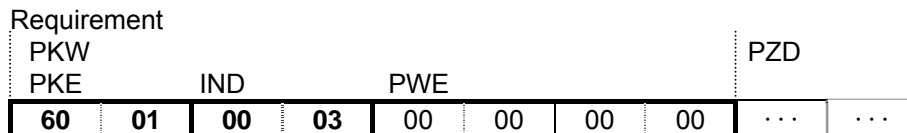
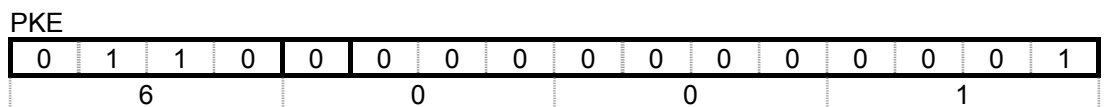

3.7.1.2. Example 2. Reading the extended parameter (F219 (VIC input point 2 frequency))

AK = 6 (Request parameter value (array))
 SPM = 0
 PNU = 1
 IND = 0x0219 (F219 communication number)

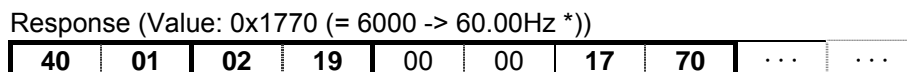
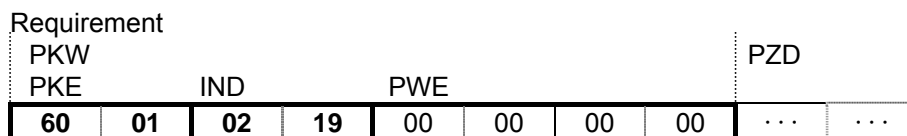
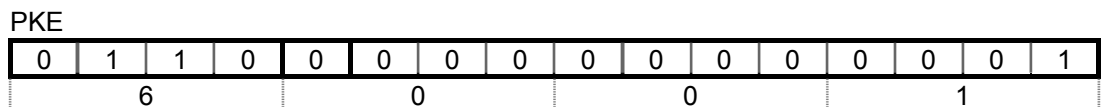

* "0x1770" as reading value of "VIC input point 2 frequency" is
 0x1770 = 6000 (decimal number)
 Since the unit of "VIC input point 2 frequency" is 0.01Hz, set the following value.
 6000 × 0.01 = 60.00Hz

3.7.1.3. Example 3. Reading the status monitor parameter (*F E 0 2* (The operation frequency))

AK = 6 (Request parameter value (array))
 SPM = 0
 PNU = 1
 IND = 0xFE02(*F E 0 2* communication number)

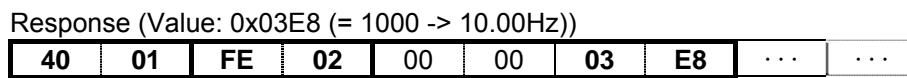
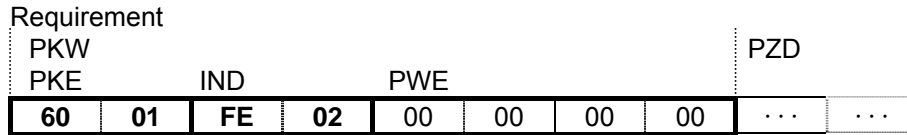
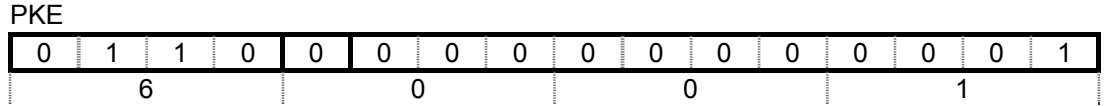

* The status monitor parameter can not be changed.

3.7.1.4. Example 4. Changing the basic parameter (*A 0 0 9* (acceleration time))

AK = 7 (Change parameter value (array))
 SPM = 0
 PNU = 1
 IND = 0x0009 (*A 0 0 9* communication number)

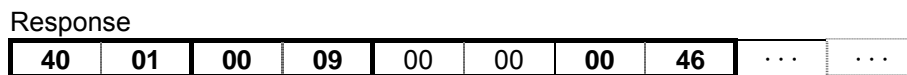
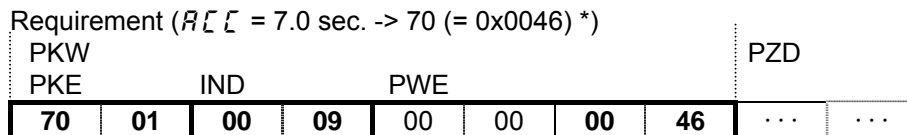
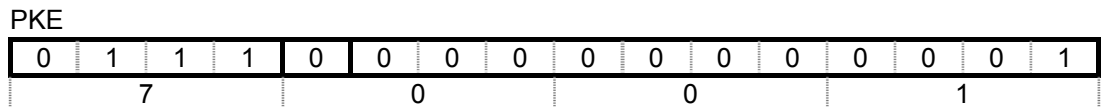

* When the "Acceleration time" is set to 7.0 sec., set the following value.
 (The unit of the "Acceleration time" is according to the parameter *F 5 1 9*.)
 7.0/0.1 = 70 = 0x0046 (hexadecimal number)

Notes	
	<ul style="list-style-type: none"> ▼ When the control power is shut off by the instantaneous power failure, communication will be unavailable for a while. ▼ The Life of EEPROM is approximately 100,000 times. Avoid writing a command more than 100,000 times to the same parameter of the drive and the communication board.

4. Vendor Spec. Profile

Cyclic command transmission (the value of the parameter $C001 - C006$) and monitoring (the value of the parameter $C021 - C026$) are possible for PDP003Z by the original profile

Select the "Telegram 100", "Telegram 101" or "Telegram 102" as the profile on the configuration. Refer to the PLC configurator documents.

$C001 - C006$ setup value	$C021 - C026$ setup value
0: No action	0: No action
1: $F006$ (Communication command 1)	1: $F001$ (Status information 1)
2: $F023$ (Communication command 2)	2: $F000$ (Output frequency, 0.01Hz)
3: $F007$ (Frequency command, 0.01Hz)	3: $F003$ (Output current, 0.01%)
5: $F050$ (Terminal output data)	4: $F005$ (Output voltage, 0.01%)
6: $F051$ (FM analog output)	5: $F091$ (Alarm information)
8: $F501$ (Stall prevention level, %)	6: $F022$ (PID feedback value, 0.01Hz)
13: $A00$ (Acceleration time 1, 0.1s)*	7: $F006$ (Input terminal board status)
14: $d00$ (Deceleration time 1, 0.1s)*	8: $F007$ (Output terminal status)
15: UL (Upper limit, 0.01Hz)	9: $FE36$ (VIB input, 0.01%)
16: ub (Torque boost value 1, 0.1%)	10: $FE35$ (VIA input, 0.01%)
17: $uL u$ (Base frequency voltage 1, 0.1V)	11: $FE37$ (VIC input, 0.01%)
	12: $F004$ (Input voltage (DC detection), 0.01%)
	13: $Fd16$ (Estimated speed (real-time value), 0.01Hz)
	14: $Fd18$ (Torque, 0.01%)
	19: $F880$ (Free notes)
	20: $Fd29$ (Input power, 0.01kW)
	21: $Fd30$ (Output power, 0.01kW)
	22: $FE14$ (Cumulative operation time, hour)
	23: $FE40$ (FM terminal output monitor, 0.01%)
	25: $Fd20$ (Torque current, 0.01%)
	26: $Fd23$ (Motor overload factor, 0.01%)
	27: $Fd24$ (Drive overload factor, 0.01%)
	28: $Fd25$ (PBR overload factor, %)
	29: $Fd26$ (Motor load factor, %)
	30: $Fd27$ (Drive load factor, %)
	31: $FE56$ (Pulse train input, pps)
	32: $FE70$ (Drive rated current, 0.1A)
	33: $FE76$ (Input Watt-hour, $0.1\text{kWh} \times 10^{F749}$)**
	34: $FE77$ (Output Watt-hour, $0.1\text{kWh} \times 10^{F749}$)**
	35: $Fd83$ (IGBT temperature, degree C)

* The unit of $A00$, $d00$ is according to the parameter $F519$.

** The unit of $FE76$, $FE77$ is according to the parameter $F749$.

4.1. How to use

The purposes are adjustment by real time command transmission, and the monitor of an operation state by using cyclic communication of PROFIBUS.

Example 1: Command transmitting

When you want to set "0xC400" to parameter *FA06*, set "1 (*FA06*)" to parameter *LD01*.

And Since 0 and 1 byte of the PZD1 supports the parameter *LD01*, if "0xC400" is set up here, "0xC400" will be set as *FA06*.

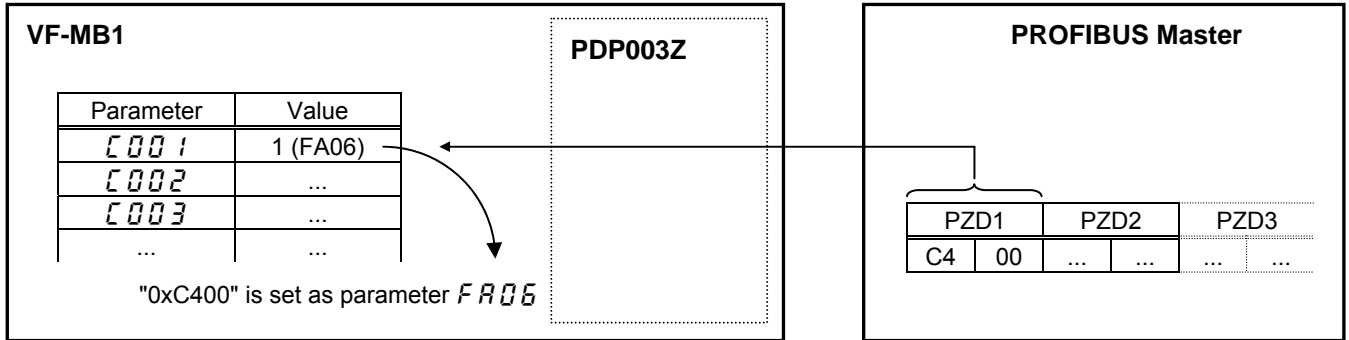

Example 2: State monitoring

When you want to monitor the output current, set "3 (FD03)" to parameter *LD01*.

The value of the parameter *FD03* specified as 0 and 1 byte of the PZD1 with the parameter *LD01* is inputted.

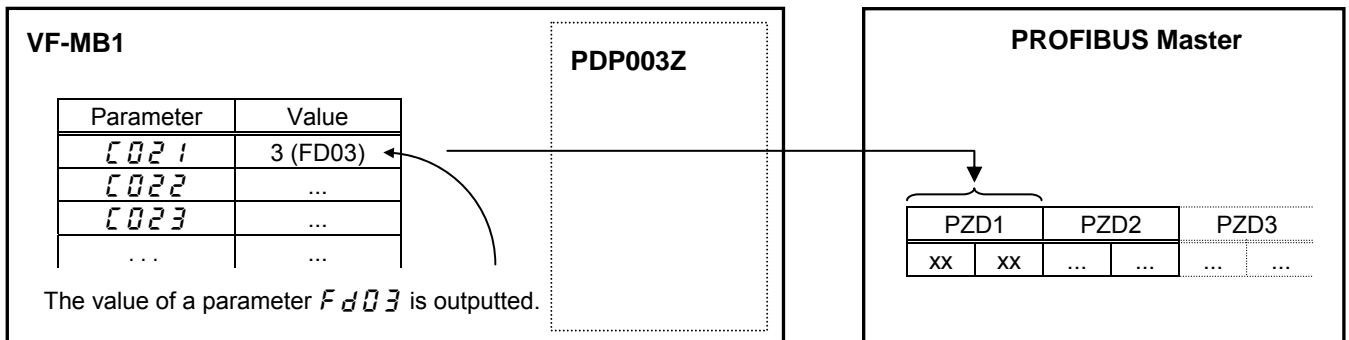

4.2. The overview of the VF-MB1/S15 parameter

Refer to a communication functional description (E6581726/E6581913) for details.

4.2.1. *FREQ* (Communication command1)

bit	Function	0	1	Note
0	Preset speed operation frequencies 1	Preset speed operation is disabled or preset speed operation frequencies (1-15) are set by specifying bits for preset speed operation frequencies 1-4. (0000: Preset speed operation OFF, 001-1111: Setting of preset speed operation frequencies (1-15))		
1	Preset speed operation frequencies 2			
2	Preset speed operation frequencies 3			
3	Preset speed operation frequencies 4			
4	Motor selection (1 or 2) (THR 2 selection)	Motor 1 (THR 1)	Motor 2 (THR 2)	THR 1: $Pt = \text{setting value}, tHr$ THR 2: $Pt = 0, F170, F171, F172, F173$
5	PI D control	Normal operation	PI D off	-
6	Acceleration/deceleration pattern selection (1 or 2) (AD2 selection)	Acceleration/deceleration pattern 1 (AD1)	Acceleration/deceleration pattern 2 (AD2)	AD1: <i>ACC, DEC</i> AD2: <i>F500, F501</i>
7	DC braking	OFF	Forced DC braking	-
8	Jog run	OFF	Jog run	-
9	Forward/reverse run selection	Forward run	Reverse run	-
10	Run/stop	Stop	Run	-
11	Coast stop command	Standby	Coast stop	-
12	Emergency stop	OFF	Emergency stop	Always enable, "E" trip
13	Fault reset	OFF	Reset	No data is returned from the drive
14	Frequency priority selection	OFF	Enabled	Enabled regardless of the setting of <i>FPOd</i>
15	Command priority selection	OFF	Enabled	Enabled regardless of the setting of <i>CPOd</i>

* VF-S15:When 14(*SR0*) is set to *FPOd*, preset speed operation frequency 0 is selected.

4.2.2. *FRZ* (Communication command 2)

bit	Function	0	1	Note
0	(Reserved)	-	-	-
1	Electric power quantity reset	OFF	Reset	Electric power quantity (<i>FE 75</i> , <i>FE 77</i>) reset
2	(Reserved)	-	-	-
3	(Reserved)	-	-	-
4	(Reserved)	-	-	-
5	(Reserved)	-	-	-
6	(Reserved)	-	-	-
7	Maximum deceleration forced stop	Normal	Enabled	-
8	Acceleration/deceleration selection 1	00: Acceleration/deceleration 1 01: Acceleration/deceleration 2 10: Acceleration/deceleration 3		Select acceleration/deceleration 1-4 by combination of two bits.. AD1: <i>ACC, DEC</i> AD2: <i>F500, F501</i> AD3: <i>F510, F511</i>
9	Acceleration/deceleration selection 2			
10	(Reserved)	-	-	-
11	(Reserved)	-	-	-
12	OC stall level switch	OC stall 1	OC stall 2	OC stall 1: <i>F601</i> OC stall 2: <i>F185</i>
13	(Reserved)	-	-	-
14	(Reserved)	-	-	-
15	(Reserved)	-	-	-

Note: Set 0 to reserved bit.

4.2.3. *F R 0 7* (frequency reference from internal option)

Frequency reference is set up by 0.01Hz unit and the hexadecimal number.

For example, when "Frequency reference" is set up to 80Hz, since the minimum unit is 0.01Hz,
 $80 / 0.01 = 8000 = 0x1F40$ (Hex.)

4.2.4. *F R 5 0* (Terminal output data from communication)

By setting up the data of the bit 0 - 1 of terminal output data (*F R 5 0*) from communication, setting data (OFF or ON) can be outputted to the output terminal.

Please select the functional number 92 - 95 as the selection (*F 1 3 0* - *F 1 3 8*) of the output terminal function before using it.

bit	Output TB function name	0	1
0	Specified data output 1 (Output terminal No.: 92, 93)	OFF	ON
1	Specified data output 2 (Output terminal No.: 94, 95)	OFF	ON
2-15	(Reserved)	-	-

Note: Set 0 to reserved bit

4.2.5. *F R 5 1* (Analog output (FM) data from communication)

Use this function, set the FM terminal meter selection parameter (*F R 5 1*) to 18 (communication data output).

This makes it possible to send out the data specified as FM analog output data (*F R 5 1*) though the FM analog output terminal. Data can be adjusted in a range of 0 to 1000 (resolution of 10 bit).

Please refer to "Meter setting and adjustment" Section of the VF-MB1/S15 instruction manual for details.

4.2.6. *Fd01* (Inverter operating status 1 (real time))

bit	Function	0	1	Note
0	Failure FL	No output	Under in progress	-
1	Failure	Not tripped	Tripped	Trip status includes <i>rtrY</i> and the trip retention status are also regarded as tripped statuses.
2	Alarm	No alarm	Alarm issued	-
3	Under voltage (<i>NOFF</i>)	Normal	Under voltage	-
4	Motor selection (1 or 2) (THR 2 selection)	Motor 1 (THR1)	Motor 2 (THR2)	THR1: <i>Pt</i> = setting value, <i>uL</i> , <i>uLu</i> , <i>ub</i> , <i>tHr</i> THR2: <i>Pt</i> = 0, <i>F170</i> , <i>F171</i> , <i>F172</i> , <i>F173</i>
5	PID control off	PID control permitted	PID control prohibits	-
6	Acceleration/deceleration pattern selection (1 or 2)	Acceleration/deceleration pattern 1 (AD1)	Acceleration/deceleration pattern 2 (AD2)	AD1: <i>ACC</i> , <i>DEC</i> AD2: <i>F500</i> , <i>F501</i>
7	DC braking	OFF	Forced DC braking	-
8	Jog run	OFF	Jog run	-
9	Forward / reverse run	Forward run	Reverse run	-
10	Run/stop	Stop	Run	-
11	Coast stop (ST = OFF)	ST=ON	ST=OFF	-
12	Emergency stop	No emergency stop status	Emergency stop status	-
13	Standby ST=ON	Start-up process	Standby	Standby: Initialization completed, not failure stop status, not alarm stop status (<i>NOFF</i> , <i>LL</i> forced stop), ST=ON, and RUN=ON
14	Standby	Start-up process	Standby	Standby: Initialization completed, not failure stop status and not alarm stop status (<i>NOFF</i> , <i>LL</i> forced stop)
15	(Undefined)	-	-	-

Note: The bit described "Undefined" is unstable. Don't use the bit for the judgment.

4.2.7. *Fd00* (Output frequency (real time))

The current output frequency is read into 0.01Hz of units and by the hexadecimal number. For example, when the output frequency is 80Hz, 0x1F40 (hexadecimal number) are read.

Since the minimum unit is 0.01%,
 $0x1F40 \text{ (Hex.)} = 8000 \text{ (Dec.)} * 0.01 = 80 \text{ (Hz)}$

Also about the following parameters, these are the same as this.

- *Fd22* (Feedback value of PID (real time)) Unit: 0.01Hz
- *Fd16* (Estimated speed (real time)) Unit: 0.01Hz
- *Fd29* (Input power (real time)) Unit: 0.01kW
- *Fd30* (Output power (real time)) Unit: 0.01kW

4.2.8. *F d 0 3* (Output current (real time))

The output current is read into 0.01% of units and by the hexadecimal number.

For example, when the output current of the rated current 4.8A drive is 50% (2.4A), 0x1388 (hexadecimal number) is read out.

Since the minimum unit is 0.01%,

$$0x1388 \text{ (Hex.)} = 5000 \text{ (Dec.)} * 0.01 = 50 \text{ (\%)}$$

Also about the following parameters, these are the same as this.

- *F d 0 5* (Output voltage (real time))..... Unit: 0.01% (V)
- *F d 0 4* (Voltage at DC bus (real time))..... Unit: 0.01% (V)
- *F d 1 8* (Torque) Unit: 0.01% (Nm)*

* When the motor information connected to the drive set to the parameter (*F 4 0 5* - *F 4 1 5*), torque monitor value "100%" is same as the rated torque of a motor in general.

4.2.9. *F E 3 5, F E 3 6, F E 3 7* (Monitoring of the analog input VIA, VIB, VIC)

VIA terminal board monitor: "Communication Number *F E 3 5*"

VIB terminal board monitor: "Communication Number *F E 3 6*"

VIC terminal board monitor: "Communication Number *F E 3 7*"

These monitors can also be used as A/D converters irrespective of the drive's control.

VIA / VIC terminal board monitor is capable of reading the data from external devices in a range of 0.01 to 100.00% (unsigned data: 0x0000 to 0x2710).

VIB terminal board monitor is capable of reading the data from external devices in a range of -100.00 to 100.00% (signed data: 0xD8F0 to 0x2710).

If analog input mode is selected with the frequency setting mode selection parameter, however, keep in mid that any data entered via an analog terminal is regarded as a frequency command.

4.2.10. *F E 1 4* (Cumulative run time)

The operated cumulative time is read by the hexadecimal number.

For example, when cumulative operation time is 18 hours, 0x12 (18 hours) is read.

$$0x12 \text{ (Hex.)} = 18 \text{ (Dec., hour)}$$

4.2.11. *F E 4 0* (Analog output (FM))

The output value of FM terminal is read.

The value range is set to 0 to 10000 (0x2710).

4.2.12. *F 1 9 1* (Alarm code)

bit	Function	0	1	Remarks (Code displayed on the panel)
0	Over-current alarm	Normal	Alarming	<i>L</i> flicking
1	Inverter over load alarm	Normal	Alarming	<i>L</i> flicking
2	Motor over load alarm	Normal	Alarming	<i>L</i> flicking
3	Over heat alarm	Normal	Alarming	<i>H</i> flicking
4	Over voltage alarm	Normal	Alarming	<i>P</i> flicking
5	Main circuit undervoltage alarm	Normal	Alarming	-
6	main device overheat alarm	Normal	Alarming	<i>L</i> flicking
7	Under current alarm	Normal	Alarming	-
8	Over-torque alarm	Normal	Alarming	-
9	Braking resistor overload alarm	Normal	Alarming	-
10	Cumulative operation hours alarm	Normal	Alarming	-
11	Option communication alarm	Normal	Alarming	-
12	Serial communication alarm	Normal	Alarming	-
13	MOFFMS (MSrelay off or MOFF)	Normal	Alarming	-
14	Stop after instantaneous power off	-	Dec., Under stop	Refer to <i>F 3 0 2</i> value
15	Stop after LL continuance time	-	Dec., Under stop	Refer to <i>F 2 5 5</i> value

4.2.13. *F 1 0 6* (Input TB Status)

bit	TB Name	Function (Parameter)	0	1
0	F	Input terminal function selection 1 (<i>F 1 1 1</i>)	OFF	ON
1	R	Input terminal function selection 2 (<i>F 1 1 2</i>)		
2	RES	Input terminal function selection 3 (<i>F 1 1 3</i>)		
3	S1	Input terminal function selection 4 (<i>F 1 1 4</i>)		
4	S2	Input terminal function selection 5 (<i>F 1 1 5</i>)		
5	S3	Input terminal function selection 6 (<i>F 1 1 6</i>)		
6	VIB*1	Input terminal function selection 7 (<i>F 1 1 7</i>)		
7	VIA*1	Input terminal function selection 8 (<i>F 1 1 8</i>)		
5 to 15	(Undefined)	-	-	-

Note: The bit described "Undefined" is unstable. Do not use the bit for the judgment.

*1: VIA/ VIB are input terminal function when *F 1 0 9* is logic input.

*The input terminal function is selected by each parameter.

4.2.14. *Fd07* (Output TB Status)

bit	TB Name	Function (Parameter)	0	1
0	RY-RC	Output terminal function selection 1A (<i>F 130</i>)	OFF	ON
1	OUT	Output TB Function select 2A (<i>F 131</i>)	OFF	ON
2	FL	Output TB Function select 3 (<i>F 132</i>)	OFF	ON
3 - 15	(Undefined)	-	-	-

Note: The bit described "Undefined" is unstable. Do not use the bit for the judgment.

5. Diagnostic

When the communication loss occurs, PDP003Z returns the diagnosis telegram including the following information.

- Byte 1: Station Status 1
- Byte 2: Station Status 2
- Byte 3: Station Status 3
- Byte 4: Master station address
- Byte 5: PDP003Z Ident Number high byte (0x0C)
- Byte 6: PDP003Z Ident Number low byte (0x24)

- Byte 7: Diagnostic data length
- Byte 8: Status Type (Status message = 0x81)
- Byte 9: Slot Number (Slot number = 0x00)
- Byte 10: Specifier (0=No further diff, 1=Status comes, 2=Status goes)

- Byte 11: External diagnostic data length
- Byte 12: PDP003Z Station Address
- Byte 13: PDP003Z Profile
- Byte 14: Drive CPU1 Major version
- Byte 15: Drive CPU1 Minor version
- Byte 16: PDP003Z software version
- Byte 17: PDP003Z communication network Fault
- Byte 18: PDP003Z internal link Fault

* It is necessary to set the parameter [10] to "4".

* It is necessary to set it by the configuration to include Byte 7 or more in the response.
(The figure below is a setting for SIMATEC Step7.)

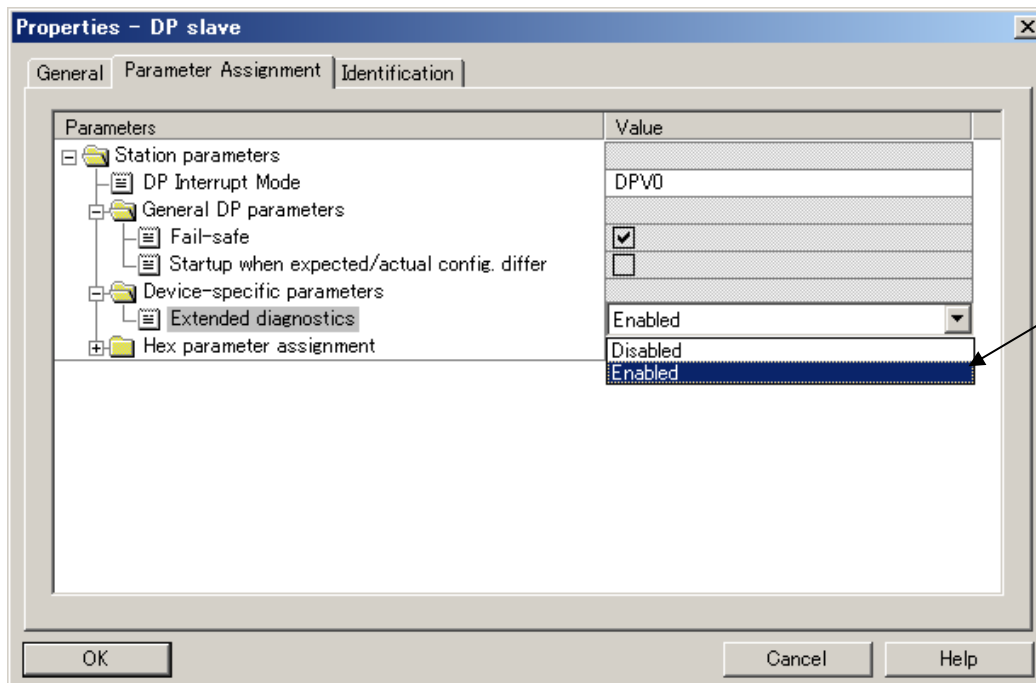

6. DP-V1 function

DP-V1 acyclic communication is mainly used to read/write the parameter. VF-MB1/S15 parameter and the PROFIBUS parameter can be read/written using PDP003Z.

The following setting is necessary in the configuration to communicate DP-V1.
(The figure below is a setting for SIMATEC Step7.)

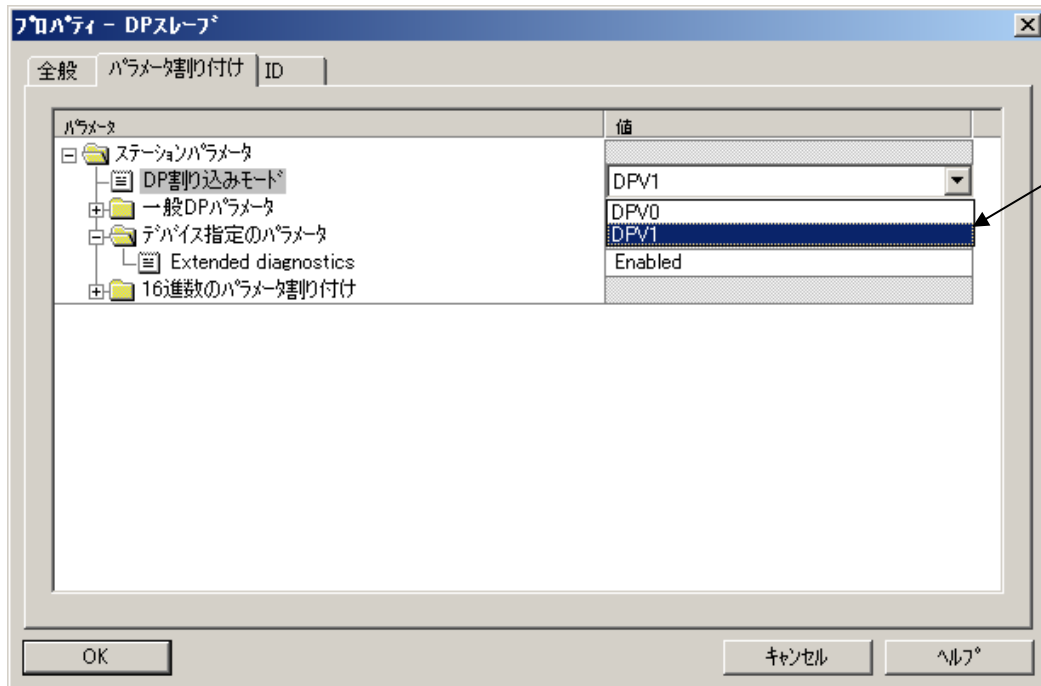

Parameter access sequence to VF-MB1/S15 takes place as described in the following figure.

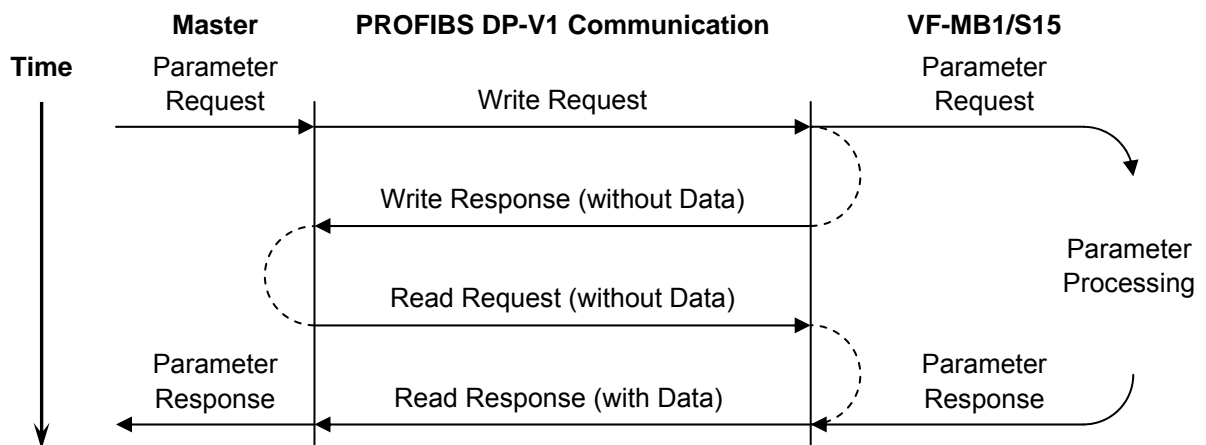

6.1. Example1. Read the PROFdrive parameter

6.1.1. Write Request data table (Read PNU 964 (0x03C4) IND 4)

Field	Description	Value
Header DU0	Function number	0x5F
Header DU1	Slot number (0)	0x00
Header DU2	Index (47)	0x2F
Header DU3	Length	0x0E
Request Header (Byte 1)	Request Reference	0x01
Request Header (Byte 2)	Request ID (0x01: Request)	0x01
Request Header (Byte 3)	Axis	0x01
Request Header (Byte 4)	Number of Parameters	0x01
Parameter Address (Byte 1)	Attribute (0x10: Value)	0x10
Parameter Address (Byte 2)	Number of Elements	0x01
Parameter Address (Byte 3)	Parameter number (PNU), High byte	0x03
Parameter Address (Byte 4)	Parameter number (PNU), Low byte	0xC4
Parameter Address (Byte 5)	Subindex (IND), High byte	0x00
Parameter Address (Byte 6)	Subindex (IND), Low byte	0x04

6.1.2. Read Response data table (positive)

Field	Description	Value
Header DU0	Function number	0x5E
Header DU1	Slot number (0)	0x00
Header DU2	Index (47)	0x2F
Header DU3	Length	0x08
Request Header (Byte 1)	Request Reference (mirrored)	0x01
Request Header (Byte 2)	Response ID *	0x01
Request Header (Byte 3)	Axis (mirrored)	0x01
Request Header (Byte 4)	Number of Parameters	0x01
Parameter Value (Byte 1)	Format *	0x06
Parameter Value (Byte 2)	Number of Values	0x01
Parameter Value (Byte 3)	Values, High byte	0x0A **
Parameter Value (Byte 4)	Values, Low byte	0x90 **

* Refer to Appendix.

** Value 0x0A90 is "2704" in decimal. This means "April 27".

6.2. Example 2. Change the PROFdrive parameter

6.2.1. Write Request data table (Change, set 0 to PNU 927 (0x039F))

Field	Description	Value
Header (DU0)	Function number	0x5F
Header (DU1)	Slot number (0)	0x00
Header (DU2)	Index (47)	0x2F
Header (DU3)	Length	0x0E
Request Header (Byte 1)	Request Reference	0x01
Request Header (Byte 2)	Request ID (0x02: Change) *	0x02
Request Header (Byte 3)	Axis	0x01
Request Header (Byte 4)	Number of Parameters	0x01
Parameter Address (Byte 1)	Attribute	0x10
Parameter Address (Byte 2)	Number of Elements	0x01
Parameter Address (Byte 3)	Parameter number (PNU), High byte	0x03
Parameter Address (Byte 4)	Parameter number (PNU), Low byte	0x9F
Parameter Address (Byte 5)	Subindex (IND), High byte	0x00
Parameter Address (Byte 6)	Subindex (IND), Low byte	0x00
Parameter Value (Byte 1)	Format *	0x06
Parameter Value (Byte 2)	Number of Value	0x01
Parameter Value (Byte 3)	Values, High byte	0x00
Parameter Value (Byte 4)	Values, Low byte	0x00

* Refer to Appendix.

Read Response data table (positive)

Field	Description	Value
Header DU0	Function number	0x5E
Header DU1	Slot number (0)	0x00
Header DU2	Index (47)	0x2F
Header DU3	Length	0x04
Request Header (Byte 1)	Request Reference (mirrored)	0x01
Request Header (Byte 2)	Response ID (0x02: Positive)	0x02
Request Header (Byte 3)	Axis (mirrored)	0x01
Request Header (Byte 4)	Number of Parameters	0x01

6.2.2. Read Response data table (negative, set 2 to PNU 927)

Field	Description	Value
Header DU0	Function number	0x5E
Header DU1	Slot number (0)	0x00
Header DU2	Index (47)	0x2F
Header DU3	Length	0x08
Request Header (Byte 1)	Request Reference (mirrored)	0x01
Request Header (Byte 2)	Response ID (0x82: Negative) *	0x82
Request Header (Byte 3)	Axis (mirrored)	0x01
Request Header (Byte 4)	Number of Parameters	0x01
Parameter Value (Byte 1)	Format (0x44: Error) *	0x44
Parameter Value (Byte 2)	Numner of Vlaues	0x01
Parameter Value (Byte 3)	Error number, High byte	0x00
Parameter Value (Byte 4)	Error number, Low byte	0x01

* Refer to Appendix.

6.3. Example 3. Read the VF-MB1/S15 parameter

When access to VF-MB1/S15 parameter, set "1000" to the PNU.

6.3.1. Write Request data table (Read F_{d04} (Input voltage))

Field	Description	Value
Header DU0	Function number	0x5F
Header DU1	Slot number (0)	0x00
Header DU2	Index (47)	0x2F
Header DU3	Length	0x0A
Request Header (Byte 1)	Request Reference	0x01
Request Header (Byte 2)	Request ID (0x01: Request) *	0x01
Request Header (Byte 3)	Axis	0x01
Request Header (Byte 4)	Number of Parameters	0x01
Parameter Address (Byte 1)	Attribute	0x10
Parameter Address (Byte 2)	Number of Elements	0x01
Parameter Address (Byte 3)	Parameter number, High byte **	0x03
Parameter Address (Byte 4)	Parameter number, Low byte **	0xE8
Parameter Address (Byte 5)	VF-MB1/S15 Parameter number, High byte	0xFD
Parameter Address (Byte 6)	VF-MB1/S15 Parameter number, Low byte	0x04

* Refer to Appendix.

** Parameter number is fixed to 0x03E8 (1000) for accessing to VF-MB1/S15 parameter.

6.3.2. Read Response data table (positive)

Field	Description	Value
Header DU0	Function number	0x5E
Header DU1	Slot number (0)	0x00
Header DU2	Index (47)	0x2F
Header DU3	Length	0x08
Request Header (Byte 1)	Request Reference (mirrored)	0x01
Request Header (Byte 2)	Response ID *	0x01
Request Header (Byte 3)	Axis (mirrored)	0x01
Request Header (Byte 4)	Number of Parameters	0x01
Parameter Value (Byte 1)	Format *	0x42
Parameter Value (Byte 2)	Number of Values	0x01
Parameter Value (Byte 3)	Values, High byte	0x31 **
Parameter Value (Byte 4)	Values, High byte	0xEC **

* Refer to Appendix.

** Value 0x31EC is "12780" in decimal. This means "127.80 (%)".

6.4. Example 4. Change the VF-MB1/S15 parameter

When access to VF-MB1/S15 parameter, set "1000" to the PNU.

* This procedure changes the value of VF-MB1/S15 EEPROM.

6.4.1. Write Request data table (Change, set 7 to VF-MB1/S15 parameter *F 130*)

Field	Description	Value
Header DU0	Function number	0x5F
Header DU1	Slot number (0)	0x00
Header DU2	Index (47)	0x2F
Header DU3	Length	0x0E
Request Header (Byte 1)	Request Reference	0x01
Request Header (Byte 2)	Request ID (0x02: Change) *	0x02
Request Header (Byte 3)	Axis	0x01
Request Header (Byte 4)	Number of Parameters	0x01
Parameter Address (Byte 1)	Attribute	0x10
Parameter Address (Byte 2)	Number of Elements	0x01
Parameter Address (Byte 3)	Parameter number, High byte **	0x03
Parameter Address (Byte 4)	Parameter number, Low byte **	0xE8
Parameter Address (Byte 5)	VF-MB1/S15 Parameter number, High byte	0x01
Parameter Address (Byte 6)	VF-MB1/S15 Parameter number, Low byte	0x30
Parameter Value (Byte 1)	Format *	0x42
Parameter Value (Byte 2)	Number of Value	0x01
Parameter Value (Byte 3)	Value, High byte	0x00
Parameter Value (Byte 4)	Value, Low byte	0x07

* Refer to Appendix.

** Parameter number is fixed to 0x03E8 (1000) for accessing to VF-MB1/S15 parameter.

6.4.2. Read Response data table (positive)

Field	Description	Value
Header DU0	Function number	0x5E
Header DU1	Slot number (0)	0x00
Header DU2	Index (47)	0x2F
Header DU3	Length	0x04
Request Header (Byte 1)	Request Reference (mirrored)	0x01
Request Header (Byte 2)	Response ID *	0x02
Request Header (Byte 3)	Axis (mirrored)	0x01
Request Header (Byte 4)	Number of Parameters	0x01

* Refer to Appendix.

6.4.3. Read Response data table (negative, at set 256 to *F 130*)

Field	Description	Value
Header DU0	Function number	0x5E
Header DU1	Slot number (0)	0x00
Header DU2	Index (47)	0x2F
Header DU3	Length	0x08
Request Header (Byte 1)	Request Reference (mirrored)	0x01
Request Header (Byte 2)	Response ID *	0x82
Request Header (Byte 3)	Axis (mirrored)	0x01
Request Header (Byte 4)	Number of Parameters	0x01
Parameter Value (Byte 1)	Format * (= Error)	0x44
Parameter Value (Byte 2)	Numner of Vlaues	0x01
Parameter Value (Byte 3)	Error number, High byte *	0x00
Parameter Value (Byte 4)	Error number, Low byte *	0x02

* Refer to Appendix.

7. PROFIBUS Local/Remote Operation

The example below shows how to configure the VF-MB1 for local/remote operation.

<Terminal function>

F terminal RUN command
 R terminal..... Local (Terminal in this example) / PROFIBUS switching
 VIA terminal Operation frequency command

<Wiring>

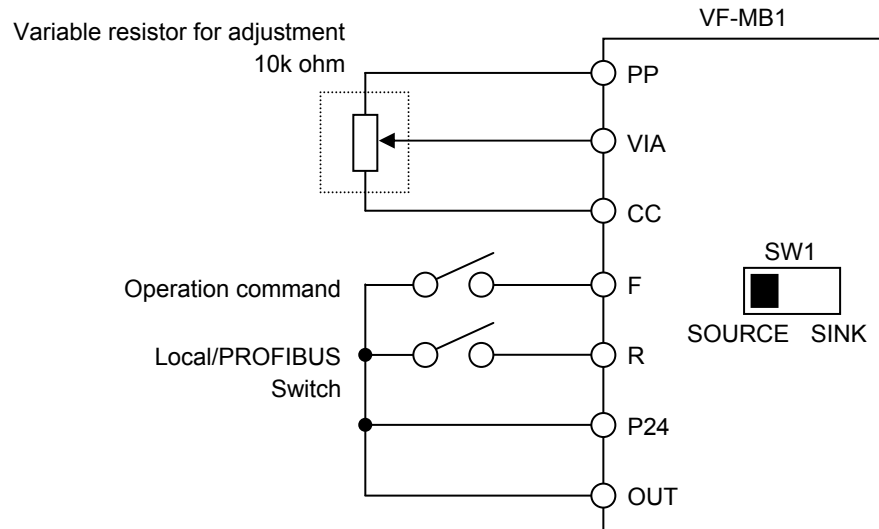

<Parameter setting>

CMD (command mode selection) = 0 (terminal board)
 $FREQ$ (frequency setting mode selection 1) = 1 (VIA)
 $F12$ (input terminal selection 2 (R)) = 48 (Local/PROFIBUS control)

<Operation>

R-CC terminal open:
 VF-MB1 is controlled as slave device of PROFIBUS.
 R-CC terminal closed:
 F-CC terminal short to RUN
 F-CC terminal open to STOP
 Output frequency is set up by the VIA signal input.

8. GSD file

As for acquisition of an GSD file for VF-MB1 and VF-S15, please contact your Toshiba distributor.

9. Appendix

Function number

0x5E: Read Request
0x5F: Write Request
0x5E: Positive response for Read request
0x5F: Positive response for Write request
0xDE: Negative response for Read request
0xDF: Negative response for Write request

Request ID

0x01: Request the value
0x02: Change the value

Response ID

0x01: Positive response for Request the value
0x02: Positive response for Change the value
0x81: Negative response for Request the value
0x82: Negative response for Change the value

Axis

0x00: (Fixed for PDP003Z)

Error number

0x00: Impermissible parameter number
0x01: Impermissible parameter number
0x02: Low or High limit exceeded
0x03: Faulty subindex
0x04: No array
0x05: Incorrect data type
0x06: Setting not permitted (may only be reset)
0x07: Description element cannot be changed
0x09: No description data available
0x0B: No operation priority
0x0F: No text array available
0x11: Request cannot be executed because of operating state
0x14: Value impermissible
0x15: Response too long
0x17: Write Req., Illegal format/format of the parameter data is not supported
0x18: Number of values are not consistent
0x19: Axis/DO non existent
0x20: Parameter text element cannot be changed

Format

0x01: Boolean
0x02: Integer 8
0x03: Integer 16
0x04: Integer 32
0x05: Unsigned 8
0x06: Unsigned 16
0x07: Unsigned 32
0x08: FloatingPoint
0x09: VisibleString
0x10: OctetString
0x12 TimeOfDay (with date indication)
0x13: TimeDifference
0x40: Zero
0x41: Byte
0x42: Word
0x43: Double word
0x44: Error