

図面番号 DRAWING NO. M0720329

変更記号 REV. MARK 1

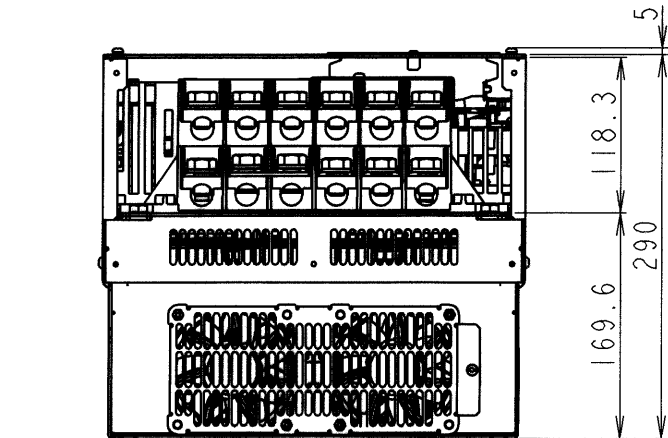
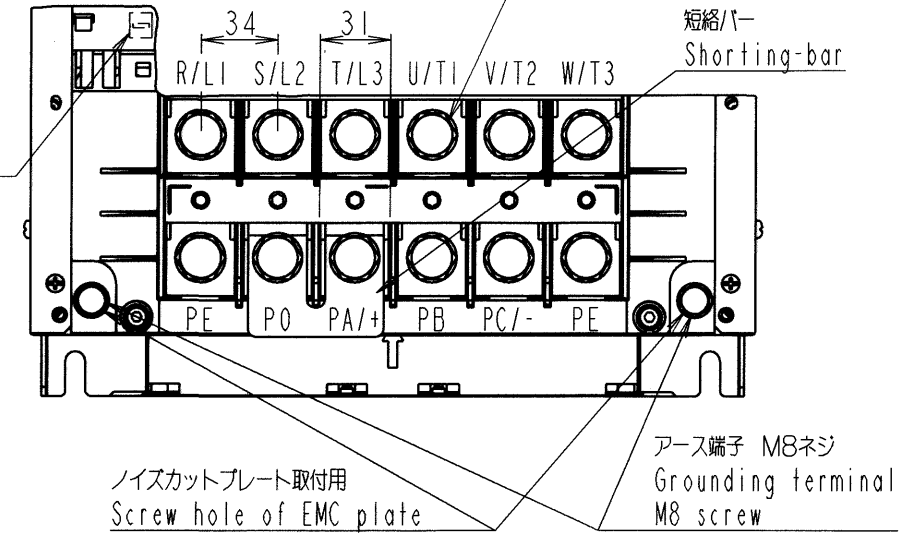
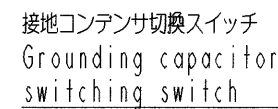
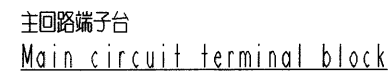
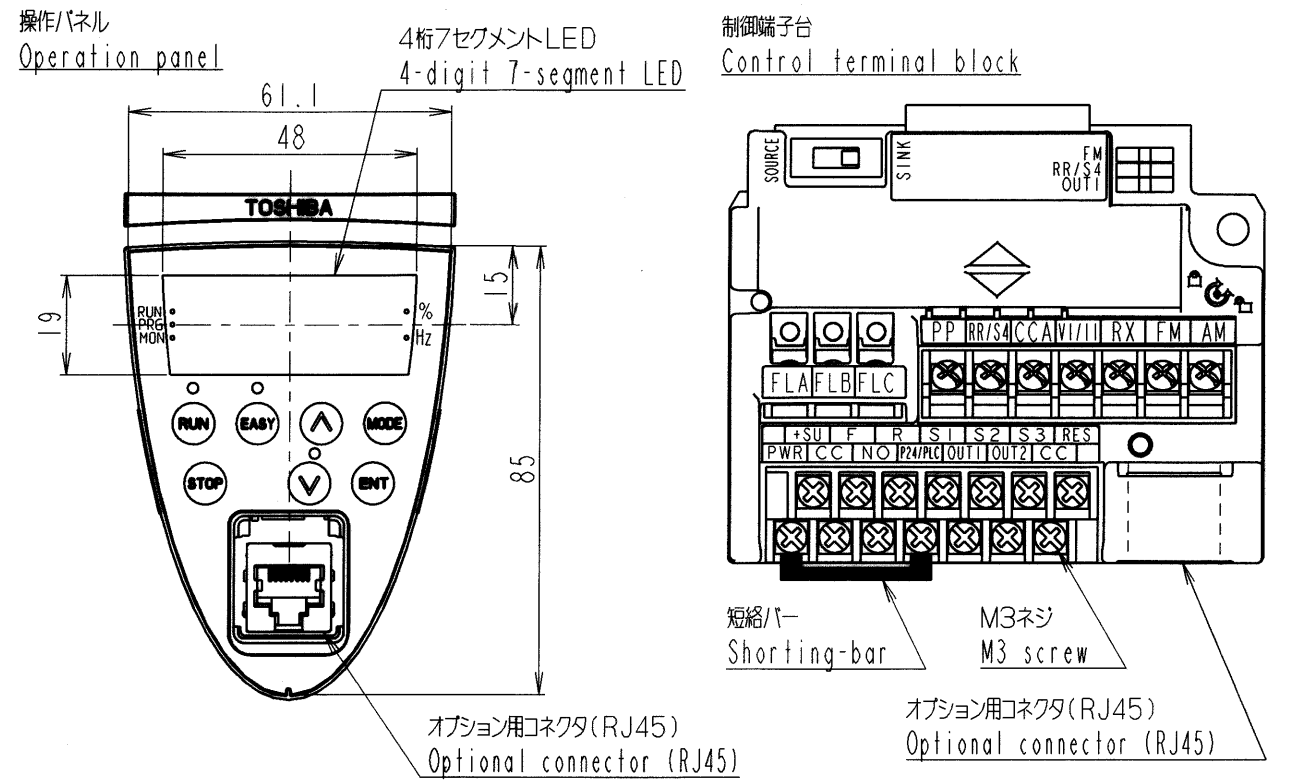
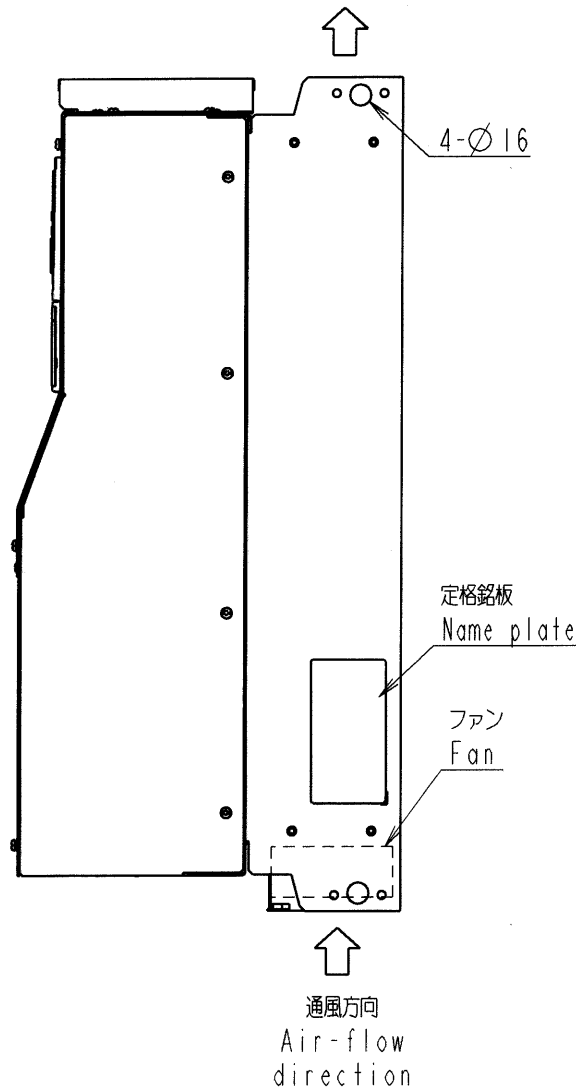
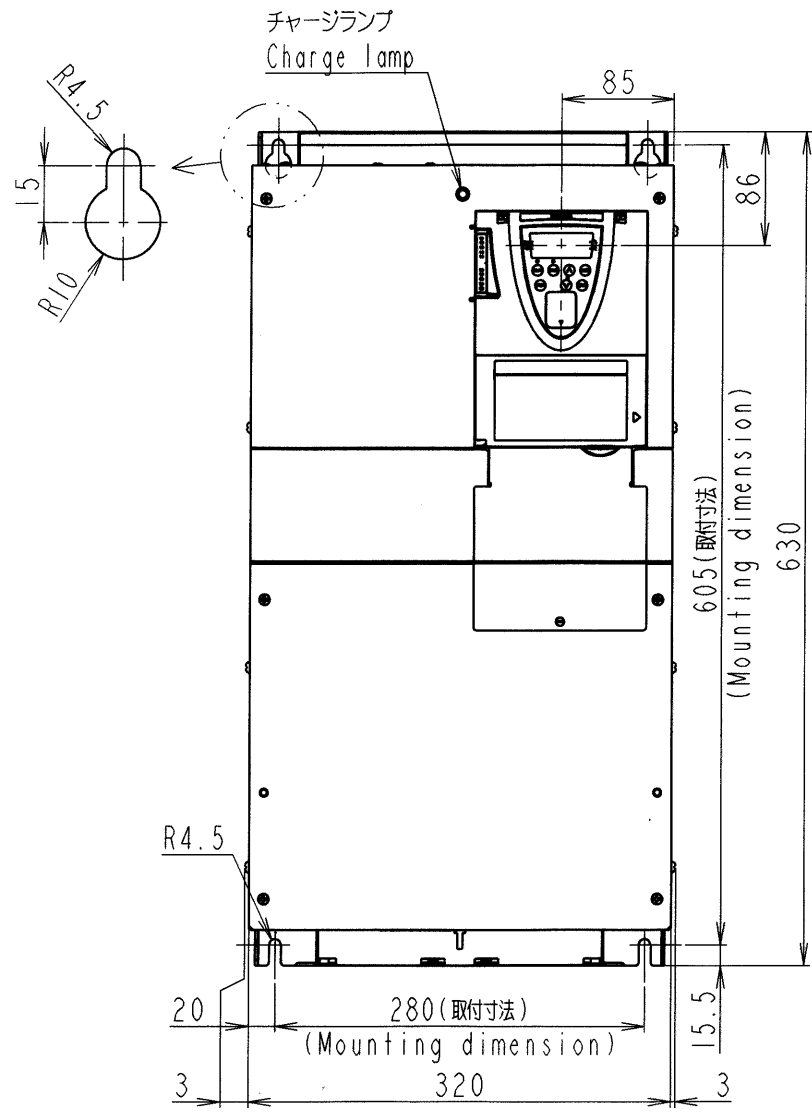

本体色:RAL7016(Dark grey)
JIS表示記号 10B 2.5/1
Box color:RAL7016(Dark grey)
JIS 10B 2.5/1

形式	概略質量(kg)
Inverter model	Approx. mass
VFPSI-4450PL	48
VFPSI-4550PL	48
VFPSI-4750PL	48

INVERTER	VFPSI	4450PL, 4550PL, 4750PL
器具名称	形	式
APPARATUS	TYPE	FORM

承認 APPROVED BY S. Shirai 9. Aug. 2006	検図 CHECKED BY O. Yamamoto 9. Aug. 2006	名称 TITLE インバータ外形図 OUTLINE OF INVERTER TOSVERT VF-PSI SERIES
設計 DESIGNED BY M. Takeuchi 9. Aug. 2006	製図 DRAWN BY M. Takeuchi 9. Aug. 2006	

TOSHIBA 東芝シュネデールインバータ株式会社
Toshiba Schneider Inverter Corporation

図面番号 DRAWING NO. M0720329 変更記号 REV. MARK 1

保管 REGISTERED 06.8.10 XM

配布先 PRESENT TO ○○○○ 8