

LCD Remote Keypad Instruction Manual

RKP004Z

Notice

1. Please see to it that this instruction manual reaches the actual user of the LCD remote keypad without fail.
2. Be sure to read this instruction manual carefully before installing and using the LCD remote keypad. After reading the manual, be sure to store it.





Introduction

Thank you for purchasing a LCD remote keypad (RKP004Z) designed specifically for Toshiba VF-AS1/PS1 series industrial inverters.

The use of this LCD remote keypad (also referred to as the unit, the product and the remote keypad) equipped with a high-resolution liquid crystal display with back lighting makes it easier to set parameters or monitor the operation.

The unit can be mounted easily on an inverter's operation panel, and on a board by means of an optional attachment. Moreover, using the unit along with a dedicated interconnect cable makes it possible to operate the inverter by remote control.

This instruction manual mainly explains how to use the keys on the LCD remote keypad. For details of parameters available, refer to the instruction manual included with your inverter.

 Warning	
 Prohibited	<ul style="list-style-type: none">• Never connect the unit to any inverter other than a VF-AS1/PS1 series inverter or any communications device. Do not use any cable other than an optional interconnect cable designed specifically for the unit. Failure to observe this might cause the unit to break down and result in an electric shock or fire.

■ Explanation of model code

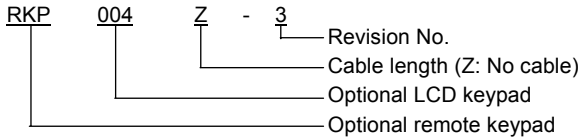

■ Check product purchase

Before using the unit, make sure all the following items are packaged with the product.

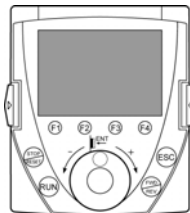



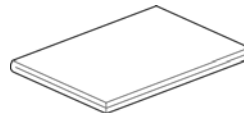



Product (remote keypad)
(RKP004Z)



Instruction Manual (1)
This manual

■ Optional products

The products listed below are optionally available. Purchase these cables and attachments separately.

Product	Model number	Product	Model number
 Interconnect cable	CAB0071 (1m)	 Connector	CNT001Z
 Interconnect cable	CAB0073 (3m)	 IP54 attachment	SBP006Z
 Interconnect cable	CAB0075 (5m)	 IP65 attachment	SBP007Z
 Interconnect cable	CAB00710 (10m)	-	-

You can install the LCD remote keypad to the inverter or operate the inverter by remote control combining optional products.

⇒ For details, refer to “2. Installing the LCD remote keypad.”

«Installation on an inverter (no optional products required)»



RKP004Z

«Installation on a board»



RKP004Z

+



SBP006Z

+



CAB0□□□□

«Installation on a board (protective structure)»



RKP004Z

+



SBP006Z

+



SBP007Z

+



CAB0□□□□

«Remote control»



RKP004Z

+



CNT001Z

+





CAB0□□□□

□: 071, 073, 075, 0710

Safety precautions

On the inverter and in its instruction manual, important information is contained for preventing injuries to users, damages to assets, and for proper use of the device. Read the instruction manual attached to the inverter along with this instruction manual to completely understand the safety precautions, the symbols and indications shown below. Please adhere to the contents of these manuals at all times.



Explanation of markings

Marking	Meaning of marking
 Warning	Indicates that errors in operation may lead to death or serious injury.
 Caution	Indicates that errors in operation may lead to injury (*1) to people or that these errors may cause damage to physical property. (*2)

(*1) Such things as injury, burns or shock that will not require hospitalization or long periods of outpatient treatment.

(*2) Physical property damage refers to wide-ranging damage to assets and materials.





Meanings of symbols

Marking	Meaning of marking
	Indicates prohibition (Don't do it). What is prohibited will be described in or near the symbol in either text or picture form.
	Indicates something mandatory (must be done). What is mandatory will be described in or near the symbol in either text or picture form.
	Indicates warning. What is warned will be described in or near the symbol in either text or picture form. Indicates caution. What the caution should be applied to will be described in or near the symbol in either text or picture form.





■ Limitation of use

 Safety precaution
<ul style="list-style-type: none">● Never use this unit with any device other than TOSVERT series inverters. Doing so may cause an accident.





■ Handling in general

 Warning	
 Never Disassemble	<ul style="list-style-type: none"> ● Never disassemble, modify or repair the product. Disassembling the product may cause electric shocks, fire or injuries. For repairs, call your sales/repair agency.
 Prohibited	<ul style="list-style-type: none"> ● Do not put or insert foreign objects such as waste cable, bars, or wires into the product. It may lead to electric shocks or fire. ● Do not splash water over the product, and do not wipe the body with a wet cloth. It may lead to electric shocks or fire.
 Mandatory	<ul style="list-style-type: none"> ● Turn off input power before wiring. Wait at least 15 minutes and check to make sure that the charge lamp (on the inverter unit) is no longer lit. ● Turn off the power immediately in case of any abnormalities such as smoke, smell or abnormal noise. Neglect of these conditions may lead to fire. For repairs, call your sales/repair agency.



■ Transportation and installation

 Warning	
 Prohibited	<ul style="list-style-type: none"> ● Do not install or operate the inverter if it is damaged or any part of it is missing. Operating a defective inverter may lead to electric shocks or fire. For repairs, call your sales/repair agency. ● Do not put any flammable material near the product. It may catch fire due to the product sparking in the case of a malfunction.
 Mandatory	<ul style="list-style-type: none"> ● Electrical construction work must be done by a qualified expert. Connection of input power by someone who does not have expert knowledge may result in fire or electric shock. ● Operate under the environmental conditions prescribed in the instruction manual. Operations under any other conditions may result in malfunction. ● An emergency stop device must be installed that fits with system specifications (e.g. shut off input power then engage mechanical brake). Operation cannot be stopped immediately by the inverter or Remote Keypad alone, thus risking an accident or injury. ● Use the Toshiba-specified cable for connecting this optional unit. (Refer to page ii.) The use of any other option may result in an accident.
 Caution	
 Prohibited	<ul style="list-style-type: none"> ● Do not install the product in any place subject to vibrations or it may fall. This may lead to the product falling and causing injury.

■ Operations

 Warning	
 Prohibited	<ul style="list-style-type: none"> Do not apply a dropping shock or other physical shocks. Otherwise, damage or malfunction will result. Do not pull on the cable and connector. It may cause damage or error. Even if this product is deactivated by an unusual event such as tripping, an operating error, power outage, etc. do not bring any regions of your body into contact with the inverter terminals when power is supplied to the inverter. Contact during the power-on status of the inverter can result in electric shock.
 Mandatory	<ul style="list-style-type: none"> Use an additional safety device with your inverter or system to prevent a serious accident due to the unit malfunctions. Usage without an additional safety device may cause an accident. Make sure to check that the parameter data from this product is not accidentally copied to the wrong inverter. Usage with wrong parameter may result in an accident.
 Caution	
 Mandatory	<ul style="list-style-type: none"> Set up “Communication error trip time (F803, F804, see the inverter instruction manual for details)” to stop the inverter when Remote Keypad is deactivated by an unusual event such as tripping, an operating error, power outage, failure, etc. Deactivated Remote Keypad may cause an accident, if the “Communication error trip time” is not properly set up.

■ Disposal

 Caution	
 Mandatory	<ul style="list-style-type: none"> If you dispose off this unit, have it done by a specialist in industrial waste disposal*. Improper disposal may result in explosion of capacitors or produce noxious gases, resulting in injury. (*) Persons who specialize in the processing of waste and known as “Industrial Waste Product Collectors and Transporters” or “Industrial Waste Disposal Persons.” If the collection, transport and disposal of industrial waste is done by someone who is not licensed for that job, it is a punishable violation of the law (Laws in regard to cleaning and processing of waste materials).

■ Notes on operations

Notes	
	<ul style="list-style-type: none"> Avoid installing in a place where ambient temperature or/and humidity change sharply. Keep the interconnect cable separate from the power cable of the inverter to prevent the inverter from malfunctioning due to electromagnetic noise. It is recommended to install the unit on the panel board of a cabinet if it is used as a remote operation panel. Improperly installed units may result in damage and malfunction.

Contents

1. Names and functions	1-1
2. Installing the LCD remote keypad	2-1
2. 1 Installing the remote keypad to the inverter	2-1
2. 2 Installing the remote keypad to the board (optional).....	2-2
2. 3 Remote control (optional)	2-3
3. Setting to be made when turning on the unit for the first time	3-1
4. About available modes	4-1
5. Operation in Top View Mode	5-1
5. 1 Setting a panel operation frequency	5-1
5. 2 Using an EASY key function.....	5-2
5. 3 Selecting a language to be displayed.....	5-4
5. 4 Performing jog run	5-5
5. 5 Emergency stop/reset operation.....	5-6
6. Operation in Parameter Setup Mode.....	6-1
6. 1 Searching for the change histories of parameters (History function).....	6-1
6. 2 Setting a basic parameter	6-2
6. 3 Setting an extended parameter	6-3
6. 4 Searching for parameters whose settings were changed (Search for changed settings)	6-4
7. Operation in Status Monitor Mode	7-1
7. 1 Displaying details of an item monitored	7-2
8. Operation in a copy function	8-1
8.1 Copy to LCD	8-2
8.2 Copy to inverter	8-3
8.3 Confirm a memory information	8-4
9. List of function key functions.....	9-1
10. Specifications	10-1
11. Before making a service call.....	11-1
12. Warranty	12-1

1. Names and functions

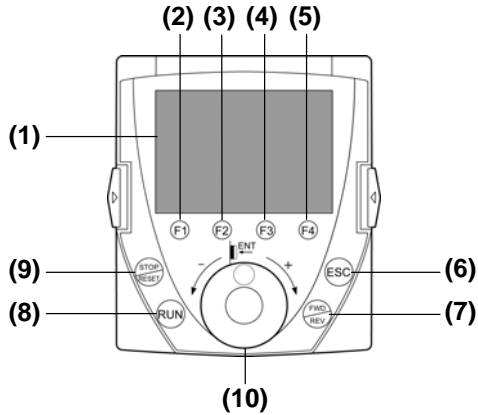

(1) LCD panel

For an explanation of windows displayed, see the next page.

(2) to (5) [F1] to [F4] function keys

The function of each function key varies depending on the window currently displayed.

⇒ Refer to the next page and “8. List of function key functions”

(6) [ESC] key

Each time this key is pressed, modes change from one to another. Also, pressing this key brings you back to the window one level higher in the window hierarchy.

(7) [FWD/REV] key

Each time this key is pressed, the direction of operation changes between forward run and reverse run.

(To use this key, parameter settings need to be changed. ⇒ Refer to page 1-3.)

(8) [RUN] key

Starts operation.

(To use this key, parameter settings need to be changed. ⇒ Refer to page 1-3.)

(9) [STOP/RESET] key

Stops operation.

(To use this key, parameter settings need to be changed. ⇒ Refer to page 1-3.)

In case the inverter has tripped, pressing this key twice in a row resets the inverter.

* If multiple commands are entered by pressing the three keys [F2], [F3] and [F4] or [ESC], [FWD] and [RUN] in rapid succession, a stop command will be issued instead to stop operation.

(10) Control dial ¹

In a menu window, turn the dial clockwise or counterclockwise to select a menu item (the item selected is highlighted) and press the dial to confirm the menu item selected.

Turn the dial clockwise (+) to select an item that follows the item currently selected.

Turn the dial counterclockwise (-) to select an item that precedes the item currently selected.

Selecting a menu item by turning the dial clockwise or counterclockwise and confirm the item selected by pressing the dial are referred to as “select/confirm an item.”

In a value setting window, turn the dial clockwise or counterclockwise to increment or decrement the value displayed, and press the dial to confirm the value specified.²
 Turn the dial clockwise (+) to increment the value.
 Turn the dial counterclockwise (-) to decrement the value.
 Turning the dial clockwise or counterclockwise to increment or decrement the value displayed and pressing the dial to confirm the value specified are referred to as “specify/confirm a value.”

*1: When the control dial is pressed, it performs the same function as the [ENT] key on the inverter’s main operation panel.
 *2: Some settings are executed only by tuning the control dial.

■ LCD panel

This section explains the features of windows available, using the top window of Status Monitor Mode as an example.

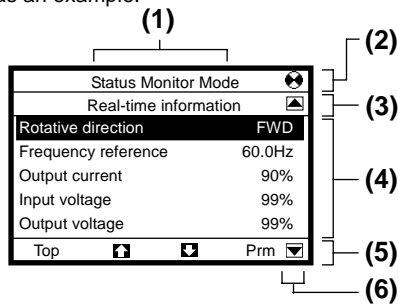

(1) Displays the mode currently selected.

(2) Displays the operating status of the inverter in a graphical symbol.

- ⊙ (rotating) : In operation
- ⊗ : Operation impossible (While the frequency is set at 0Hz, the [RUN] key is pressed.)
- EOFF (blinking) : Waiting for emergency stop operation

(3) Displays the title or status of the window.

(4) Displays settings both in a menu form and numerically, or a list of various kinds of information.

(5) Displays the function assigned to each function key in an abbreviation or graphical symbol.

The abbreviations and graphical symbols in the window correspond to the [F1] to [F4] keys, respectively starting from the left.

- Top : In this example, pressing the [F1] key displays the Top View Mode window.
- ⏪ : In this example, pressing the [F2] key displays the previous window.
- ⏩ : In this example, pressing the [F3] key displays the next window.
- Prm : In this example, pressing the [F4] key displays the Parameter Setting Mode window.

⇒ Refer to “8. List of function key functions”

(6) Graphical symbols displayed vary depending on whether there are windows that precede or follow the current window.

- ⏪ ⏩ : There are windows that precede and/or follow the current window.
- : There is no window that precedes or follows the current window.

■ About the change of parameter settings

By default, the inverter is set with parameters to the mode in which it controls the operation of the machine via a terminal board. Moreover, the inverter is set so that the switching between forward run and reverse run cannot be performed using its operation panel.

To operate the inverter using this unit, parameter settings need to be changed, as described below.

Parameter CMOD (Command input mode) =1 (Panel/LCD-option)

Parameter FMOD (Frequency input mode 1)=4 (Panel/LCD-option)

Parameter Fr (Panel FWD/REV selection) =2 (Forward (switchable)),
3 (Reverse (switchable))

This change of parameter settings makes it possible to start operation using the [RUN] key, to stop operation using the [STOP/RESET] key, and to switch between forward run and reverse run using the [FWD/REV] key.

Furthermore, it allows you to set an operation frequency using the control dial.

⇒ Refer to "5.1 Setting a panel operation frequency."

2. Installing the LCD remote keypad

The LCD remote keypad can be installed on the inverter and on the board (optional). Using this LCD remote keypad along with a dedicated interconnect cable makes it possible to operate the inverter by remote control (optional).

2.1 Installing the remote keypad to the inverter

Turn off the inverter, and then follow these steps.

1 Remove the serial RS485 port cover from the inverter's main operation panel.

To detach the cover, wrench it open using a flat-blade screwdriver or any other flat-tipped tool.

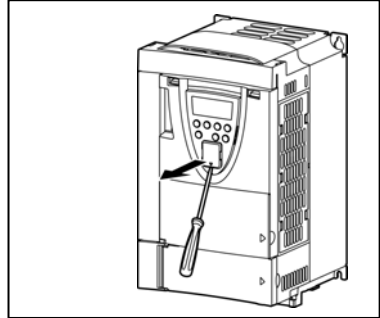

2 Mount the remote keypad on the inverter's main operation panel.

Insert the connector on the remote keypad into the RS485 port while pushing in the lock knobs, and then release the lock knobs to secure the remote keypad.

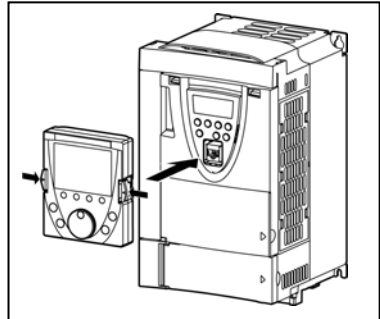

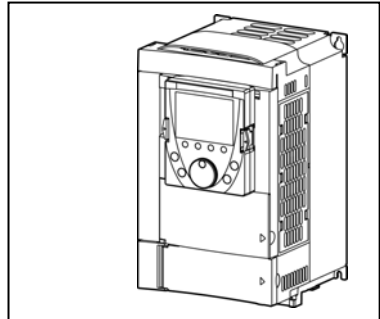

3 Make sure the remote keypad is fixed securely to the inverter.



2.2 Installing the remote keypad to the board (optional)

The remote keypad can be mounted on a board by means of an IP54 attachment (optional).

If an IP65 attachment (optional) is used in combination with an IP54 attachment, the remote keypad can be installed where it may be splashed with water.

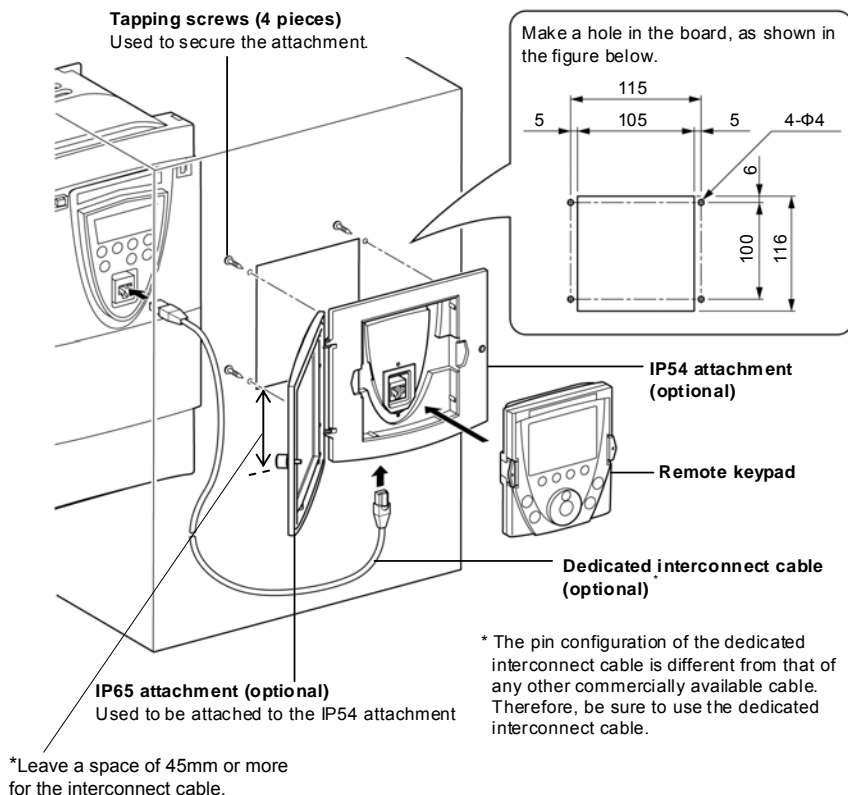

 Warning	
 Prohibited	<ul style="list-style-type: none">• Never connect the unit to any inverter other than a VF-AS1/PS1 series inverter or any communication device. Do not use any cable other than an optional interconnect cable designed specifically for the unit. If the correct cable was not used, this might cause the unit to break down and result in an electric shock or fire.

Turn off the inverter, as shown in the figure below.



2.2 Remote control (optional)

Connecting the remote keypad to the inverter unit with a dedicated interconnect cable and a connector (optional) makes it possible to operate the inverter from a distant point up to 5m from it.

 Warning	
 Prohibited	<ul style="list-style-type: none"> • Never connect the unit to any inverter other than a VF-AS1/PS1 series inverter or any communication device. Do not use any cable other than an optional interconnect cable designed specifically for the unit. If the correct cable was not used, this might cause the unit to break down and result in an electric shock or fire.

Turn off the inverter, as shown in the figure below.

<Inverter unit>

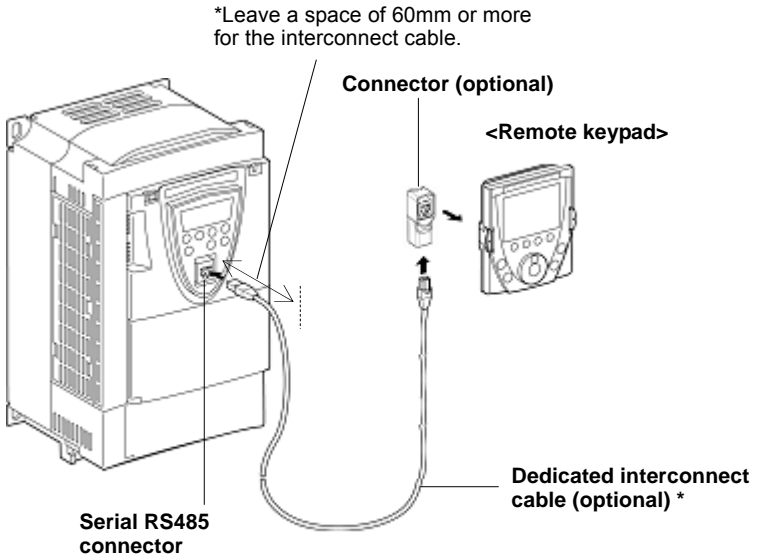

*The pin configuration of the dedicated interconnect cable is different from that of any other commercially available cable. Therefore, be sure to use the dedicated interconnect cable.

3. Setting to be made when turning on the unit for the first time

When the unit is turned on at the first time after purchase, the Language Selection window shown below appears on the LCD panel. In this window, select the language you want to display on the screen.

1 The Language Selection window appears on the screen.

This window appears only when the unit is turned on at the first time after purchase.

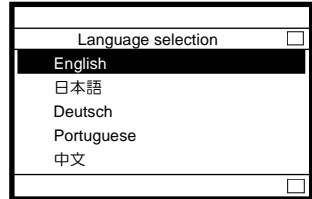

2 Select the desired language using the control dial and push the dial.

(In this example, English is selected. There is no need to select/confirm the language.)

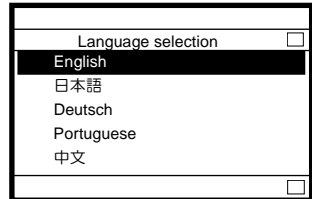

3 The Startup window is displayed and soon replaced by the top window of Top View Mode.



*: This window shows the version of the installed software. The contents of the window may be somewhat different from those of your LCD panel.

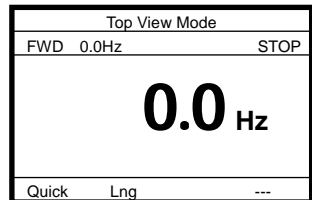

4. About available modes

The LCD remote keypad offers the following three modes, just as with the inverter's main operation panel.

(1) Top View Mode

When the remote keypad is turned on, it enters this mode first.

The top window displays the operating status.

In this mode, you can set a panel operation frequency, use a function key as the EASY key, and so on.

⇒ Refer to “5. Operation in Top View Mode.”

(2) Parameter Setup Mode

This mode allows you to set parameters.

⇒ Refer to “6. Parameter Setup Mode.”

(3) Status Monitor Mode

This mode allows you to monitor various kinds of statuses and information, such as the operating status of the inverter and information on the terminal board.

⇒ Refer to “7. Operation in Status Monitor Mode.”

The figures below show the top windows of these modes.
To change from one mode to another, press the [ESC] key.

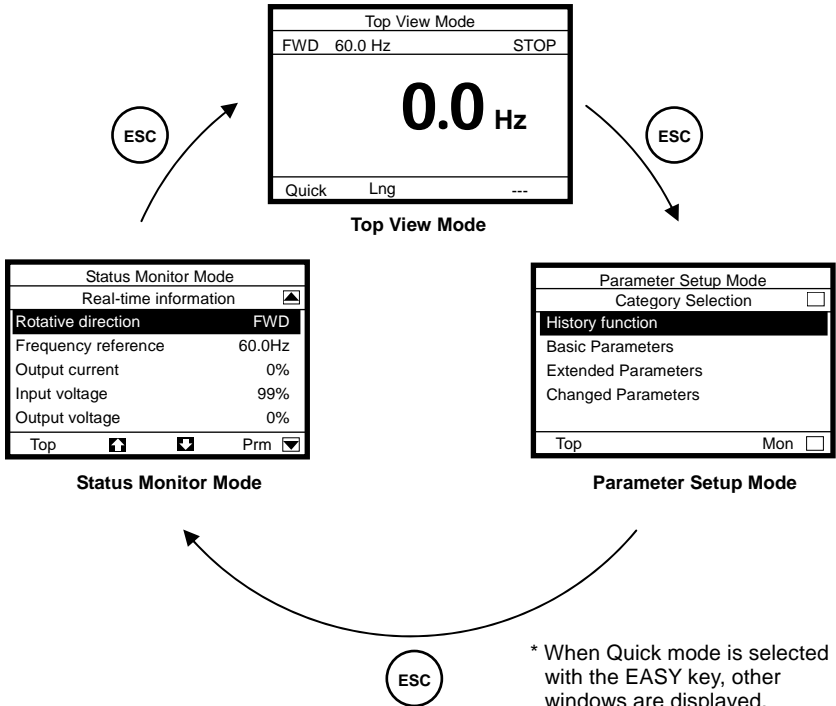

5. Operation in Top View Mode

When the remote keypad is turned on, it enters this mode first, which allows you to monitor the operating status, set an operation frequency, use a function key as the EASY key, and switch between languages.

When Panel Jog Run is selected, a jog run frequency also can be specified in this mode.

■ Explanation of the top window

- Display of commands executed:
 “FWD” or “REV” is displayed to indicate the direction of rotation.
 The operation frequency is displayed in the form of “□□. □Hz.”
- Display of operating status:
 “RUN” is displayed during operation.
 “STOP” is displayed during a stop.
 “Trip” is displayed in the event of tripping.
- Display of output frequency:
 The operation frequency is displayed in the form of “□□. □Hz.”
- Display of alarm/tripping:
 If an error or tripping occurs, an error or trip code is displayed.
- Display of error/tripping message:
 If an error or tripping occurs, an error or trip message is displayed.

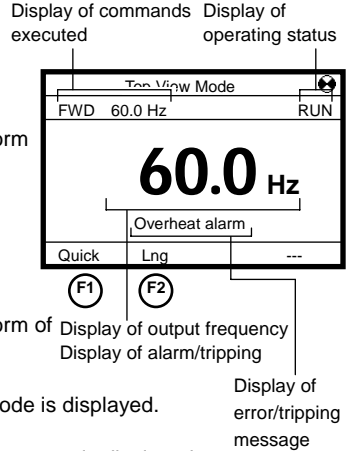

Functions of function keys

- ⓕ1: Switches between Quick mode and Standard Setting mode.
- ⓕ2: Brings you to the Language selection window.

5.1 Setting a panel operation frequency

When Frequency input mode1 (parameter FMOd=4) as a frequency setting mode, an operation frequency can be set with the remote keypad.

1 Press the control dial.

The panel frequency window appears.
 The current operation frequency setting is displayed at the center of the window.
 The current output frequency is displayed in the upper right section of the window.
 The minimum allowable frequency (min) and the maximum allowable frequency (max) are displayed at the bottom of the window.

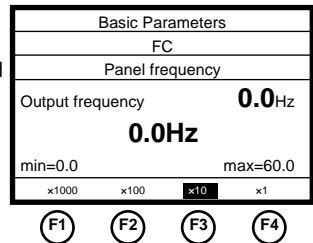

Functions of function keys

The functions keys allow you to select the position or decimal place of each figure (operation frequency) you want to increment or decrement with the control dial.

- ⓕ1: Selects the position of hundreds.
- ⓕ2: Selects the position of tens.
- ⓕ3: Selects the position of ones.
- ⓕ4: Selects the first decimal place.

2 After selecting the position of a figure you want to change, specify/confirm another figure with the control dial.

(In this example, a frequency of 30.0Hz is specified.)

Functions of function keys

The functions keys allow you to select the position or decimal place of each figure (operation frequency) you want to increment or decrement with the control dial.

- (F1) : Selects the position of hundreds.
- (F2) : Selects the position of tens.
- (F3) : Selects the position of ones.
- (F4) : Selects the first decimal place.

When you confirm the frequency specified, the screen goes back to the top window of Top View Mode.

■ To change the frequency during operation

Press the control dial during operation to display the operation panel operation frequency menu and turn the control dial to change the setting.

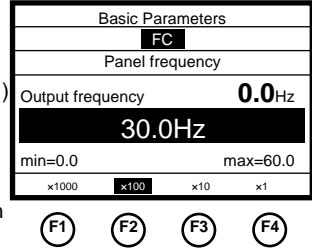

5.2 Using an EASY key function

The [F1] function key can be used as a substitute for the EASY key on the inverter's main operation panel. When the name of the function assigned to the [F1] key is displayed in the lower left corner of the window, the [F1] key can be used as the EASY key.

- “Quick” : Function of switching between Quick mode and Standard Setting mode (parameter F750=0)
- “Panel” : Function of switching between Operation Panel and Remote (parameter F750=2)
(When used with a VF-AS1 inverter)
- “Loc/Rem” : Function of switching between Local and Remote (parameter F750=2)
(When used with a VF-PS1 inverter)
- “Update” : Function of updating the Peak/Minimum Hold setting (parameter F750=3)

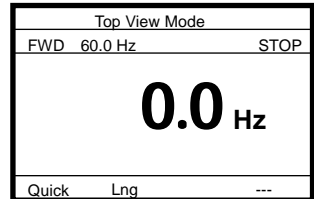

- Quick
- Panel (When used with a VF-AS1 inverter)
- Loc/Rem (When used with a VF-PS1 inverter)

* The shortcut key function (parameter F750=1) cannot be used. Even if the parameter is so set, the name of the function is not displayed on the screen.

(1) Function of switching between Quick mode and Standard Setting mode

<Standard Setting mode selected when power is turned on (parameter PSEL=0)>

- When power is turned on, "Quick" is displayed. (If the [F1] key is not pressed.)
When the unit enters Parameter Setup Mode in this situation, the ordinary top window of Parameter Setup Mode appears.
- If the [F1] key is pressed while "Quick" is displayed, "Quick" is switched from normal to reverse video " **Quick** ". (If the [F1] key is pressed.)
When the unit enters Parameter Setup Mode in this situation, the Quick mode window appears instead of the top window of Parameter Setup Mode.

<Quick mode selected when power is turned on (parameter PSEL=1)>

- When power is turned on, " **Quick** " is displayed in reverse video. (If the [F1] key is not pressed.)
When the unit enters Parameter Setup Mode in this situation, the Quick mode window appears instead of the top window of Parameter Setup Mode.
- If the [F1] key is pressed when " **Quick** " is displayed in reverse video, "Quick" is switched from reverse to normal video. (If the [F1] key is pressed.)
When the unit enters Parameter Setup Mode in this situation, the ordinary top window of Parameter Setup Mode appears.

<Always Quick mode (parameter PSEL=2)>

- " **Quick** " is displayed in reverse video.
When the unit enters Parameter Setup Mode in this situation, the Quick mode window appears instead of the top window of Parameter Setup Mode.
- * In this situation, the [F1] key is inoperative.

(2) Operation Panel and Remote (When used with a VF-AS1 inverter)

- "Panel" is displayed. (If the [F1] key is not pressed.)
In this situation, operation can be performed by remote control by means of the terminal board.
- If the [F1] key is pressed while "Panel" is displayed, "Panel" is switched from normal to reverse video " **Panel** ". (If the [F1] key is pressed.)
In this situation, operation can be performed using keys on the remote keypad.
There is no need to switch to Panel Operation mode by changing parameter settings.
- * The switching between operation modes cannot be done during operation.

(3) Operation Panel and Remote (When used with a VF-PS1 inverter)

- "Loc/ **Rem** " is displayed. (If the [F1] key is not pressed.)
In this situation, operation can be performed by remote control by means of the terminal board.
- If the [F1] key is pressed while "Panel" is displayed, "Loc/ **Rem** " is switched from normal to reverse video " **Loc** /Rem". (If the [F1] key is pressed.)
In this situation, operation can be performed using keys on the remote keypad.
There is no need to switch to Local Operation mode by changing parameter settings.
- * The switching between operation modes cannot be done during operation.

(4) Peak/Minimum Hold setting

- "Update" is displayed. (If the [F1] key is not pressed.)
The instant the [F1] key is pressed in this situation, a measurement for peak hold/minimum hold starts. When the [F1] key is pressed, " **Update** " is displayed in reverse video. (If the [F1] key is pressed.)

5.3 Selecting a language to be displayed

A language to be displayed on the screen can be selected.

In this window, the language selected when turning on the remote keypad for the first time can also be changed to the other language.

Note) When an application CPU version of VFAS1 is less than V104, you cannot choose it other than English and Japanese.

1 Press the [F2] (Lng) key.

The Language selection window appears on the screen.

Select/confirm the desired language with the control dial.

Functions of function keys

F1: Brings you to the Top View Mode.

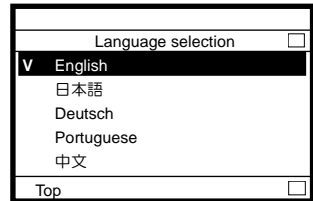

F1

2 Select/confirm the desired language with the control dial.

(In this example, Japanese is selected.)

Functions of function keys

F1: Brings you to the Top View Mode.



F1

5.4 Performing jog run

When Panel Jog Run is selected (parameter F262=1, CMOd=1), "JOG" is displayed in the lower right corner of the window. When "JOG" is displayed, jog run can be performed using the [F4] key.

The switching to jog run cannot be performed during operation. When switching to Jog Run mode, operation has to be stopped temporarily.

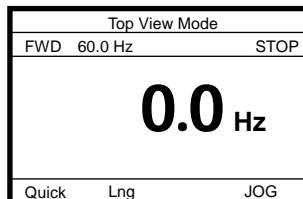



1 Press the [F4] key to carry out jog run.

The jog run frequency is displayed on the screen. (In this example, the operation frequency is set at 5.0Hz.)

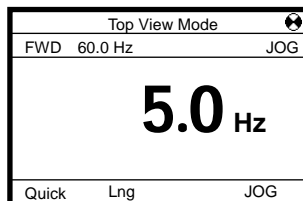
Operation continues as long as the [F4] key is pressed, and it stops when the [F4] key is released.



Functions of function keys

-  : Switches between Quick mode and Standard Setting mode.
 -  : Brings you to the Language selection window.
 -  : Executes a jog run command.
-



5.5 Emergency stop/reset operation

To make an emergency stop or to reset the inverter, follow these steps. An emergency stop can be made when operation is performed with the terminal board (parameter CMOd=0, 2, 3 or 4).

- 1 Press the [STOP/RESET] key, which displays the blinking code “EOFF” in the upper right corner of the window.

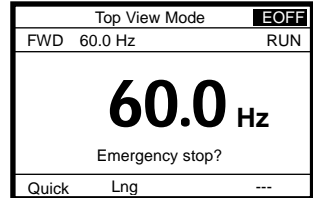

- 2 Then press the [STOP/RESET] key again. The Emergency Stop window appears and the blinking code “E” is displayed.

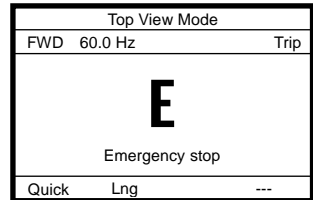

- 3 Then press the [STOP/RESET] key again. The Trip window appears and the blinking code “CLr” is displayed in it.

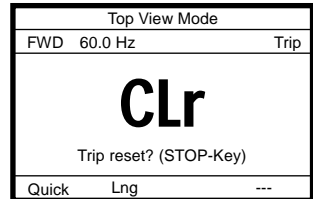

- 4 Last of all, press the [STOP/RESET] key once again to reset the inverter.

6. Operation in Parameter Setup Mode

In this mode, you can set basic parameters and extended parameters.

This mode also allows you to use the history function (inverter's parameter *RUH*) and the changed parameter search function (inverter's parameter *CRU*) easily by simply selecting the desired function from a menu.

Functions of function keys

- F1** : Brings you to the Top View Mode.
- F4** : Brings you to the Status Monitor Mode.

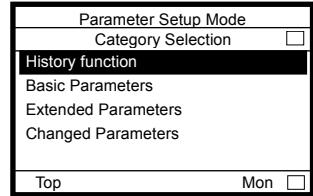

■ When Quick mode is selected

The window shown in the figure at right appears when Quick mode is selected using the EASY key function.

This window displays the parameter currently selected for Quick mode.

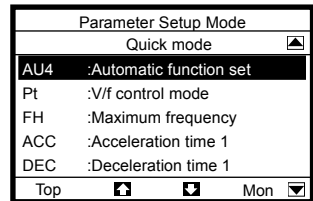

Functions of function keys

- F1** : Brings you to the Top View Mode.
- F2** : Displays the previous window.
- F3** : Displays the next window.
- F4** : Brings you to the Status Monitor Mode.

6.1 Searching for the change histories of parameters (History function)

The change histories of up to 5 parameters can also be displayed in a list form in order of novelty.

1 Select/confirm "History function" using the control dial.

Change histories are displayed in a list form in order of novelty.

If the number of change histories exceed 5, change histories except the 5 latest ones are deleted in the order in which changes were made.

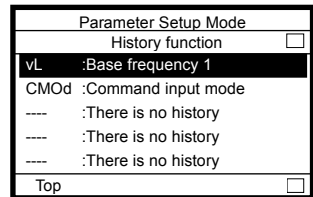

Functions of function keys

- F1** : Brings you to the Top View Mode.

■ In this window, settings can be changed.

Pressing the control dial displays the Parameter Setting window, in which you can change settings as required.

⇒ For the steps to be followed, see the following pages.

6.2 Setting a basic parameter

When Quick mode is selected using the EASY key function, skip step 1.
Go straight to step 2.

1 Select/confirm “Basic parameters” using the control dial.

The Basic Parameters window appears.

Functions of function keys

- (F1) : Brings you to the Top View Mode.
- (F2) : Displays the previous window.
- (F3) : Displays the next window.

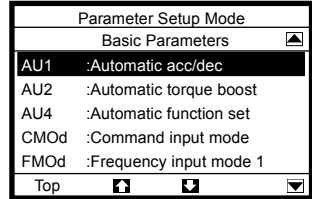

2 Select/confirm the parameter setting you want to change, using the control dial.

(Ex. Select/confirm “Command input mode” and “Base frequency 1.”)

The Parameter Setting window appears.

If the setting selected is changed by selecting a menu item, the menu item selected is highlighted and marked with a checkmark.

Functions of function keys

- (F2) : Displays the previous window.
- (F3) : Displays the next window.

● If the setting selected is changed by selecting a menu item

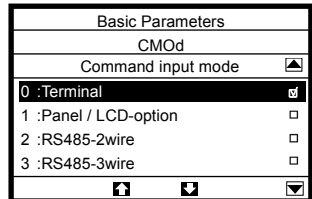

If the setting selected is changed by specifying a value, the value specified is displayed. In addition, the minimum allowable value (min) and the maximum allowable value (max) are also displayed at the bottom of the window.

Functions of function keys

The functions keys allow you to select the position or decimal place of each figure (operation frequency) you want to increment or decrement with the control dial.

- (F1) : Selects the position of hundreds.
- (F2) : Selects the position of tens.
- (F3) : Selects the position of ones.
- (F4) : Selects the first decimal place.

● If the setting selected is changed by specifying a value

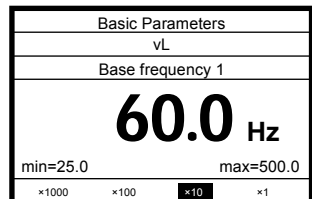

- 3 Using the control dial, select/confirm the setting you want to change by selecting a menu item or specifying a value.**
(In this example, “Panel / LCD-option” is selected and confirmed or a frequency of 90.0Hz is specified and confirmed.)

When the change you made is saved, the title of the parameter stops blinking and the screen returns to the previous window.

- If the setting selected is changed by selecting a menu item

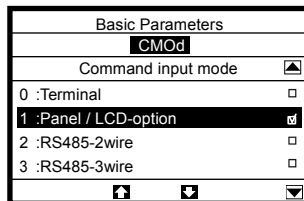

- If the setting selected is changed by specifying a value

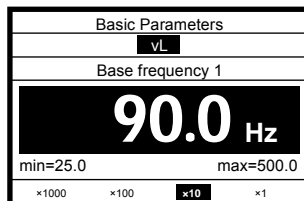

6.3 Setting an extended parameter

- 1 Select/confirm “Extended parameters” using the control dial.**

The Extended Parameters window appears.

Functions of function keys

- Ⓡ_{F1} : Displays parameters in the number range of 900.
 The number displayed decrements each time this key is pressed.
- Ⓡ_{F2} : Displays the previous window.
- Ⓡ_{F3} : Displays the next window.
- Ⓡ_{F4} : Displays parameters in the number range of 200.
 The number displayed increments each time this key is pressed.

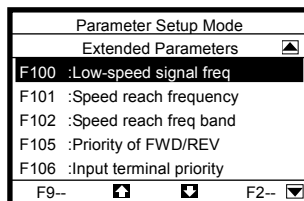

- 2 Change the parameter setting.**

To do this, perform steps 2 and 3 in the “6.2 Setting a basic parameter” section.

6.4 Searching for parameters whose settings were changed (Search for changed settings)

The remote keypad is capable of displaying parameters whose current settings are different from their default settings, and their current settings.

1 Select/confirm “Changed Parameters” using the control dial.

The Changed Parameters window appears.

Functions of function keys

- (F1) : Brings you to the Top View Mode.
- (F3) : Displays, in reverse order, parameters whose setting were changed.
- (F4) : Displays, in normal order, parameters whose setting were changed.

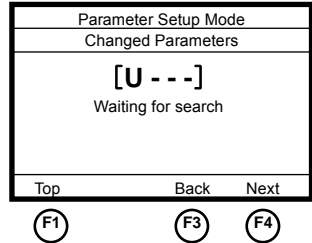

2 Search for the desired parameter by pressing the [F3] or [F4] key repeatedly.

The title, function and current setting of the parameter selected are displayed.

Functions of function keys

- (F1) : Brings you to the Top View Mode.
- (F3) : Displays, in reverse order, parameters whose setting were changed.
- (F4) : Displays, in normal order, parameters whose setting were changed.

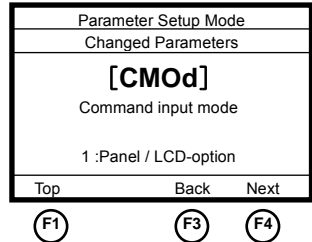

■ In this window, settings can be changed.

Pressing the control dial displays the Parameter Setting window, in which you can change settings as required.

⇒ For the operation procedure, see the previous sections.

7. Operation in Status Monitor Mode

In this mode, you can monitor various kinds of statuses and information, such as the operating status of the inverter, information on the terminal board, and trip information.

Functions of function keys

- F1** : Brings you to the Top View Mode.
- F2** : Displays the previous window.
- F3** : Displays the next window.
- F4** : Brings you to the Parameter Setup Mode.

Status Monitor Mode	
Real-time information	
Rotative direction	FWD
Frequency reference	60.0Hz
Output current	22%
Input voltage	99%
Output voltage	50%
Top	Prm



Here are the items that can be monitored in this mode and an explanation of them. These items are the same as those that can be monitored with the inverter's main operation panel.

Items displayed	Description	Display of details
Rotative direction	Rotating direction	-
Frequency reference ^{*1}	Set value and current value of parameter F711	v
Output current ^{*1}	Set value and current value of parameter F712	v
Input voltage ^{*1}	Set value and current value of parameter F713	v
Output voltage ^{*1}	Set value and current value of parameter F714	v
Torque ^{*1,*2}	Set value and current value of parameter F715	v
PBr overload ^{*1,*2}	Set value and current value of parameter F716	v
Inverter overload ^{*1,*2}	Set value and current value of parameter F717	v
Motor overload ^{*1,*2}	Set value and current value of parameter F718	v
Input terminal 1 : S4,S3...R,F	Input terminal board information (Standard terminal board)	v
Input terminal 2 : L8,L7...L1	Input terminal board information (Optional terminal board)	v
Output terminal 1 : FL...OUT2	Output terminal board information (Standard terminal board)	v
Output terminal 2 : R4...OT3	Output terminal board information (Optional terminal board)	v
Version of APP-CPU	CPU version information (Application)	-
Version of MOT-CPU	CPU version information (Motor)	-
Past trip # 1 (latest)	Trip history information 1 (latest)	v
Past trip # 2	Trip history information 2	v
Past trip # 3	Trip history information 3	v
Past trip # 4	Trip history information 4	v
Parts replacement alarm	Parts replacement alarm information	v
Cumulative run time	Cumulative run time	-

*1: The display item shows the case of a default setting.

*2: These items are not displayed when the LCD panel is used with a VF-PS1 inverter.

7. 1 Displaying details of an item monitored

1 Select/confirm the desired item using the control dial.

(Ex. Select/confirm “Output current”)

The monitor window of the item selected appears.

* Depending on the item selected, no monitor window may be displayed.

Functions of function keys

(F1) : Brings you to the Top View Mode.

(F4) : Brings you to the Parameter Setup Mode.

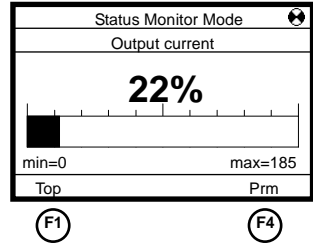

■ How to use monitor windows

Monitor windows can be broadly classified under the following three types.

<Type of window 1: Displays a value and a graph>

This type of window displays an analog value, such as an output frequency, output current or output voltage. (Ex. “Output current”)

It displays the current value both numerically and in a graph form.

In addition, the minimum allowable value (min) and the maximum allowable value (max) are also displayed at the bottom of the window.

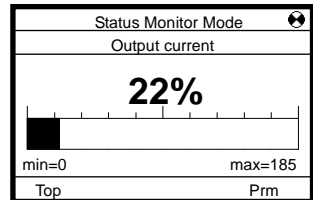

<Type of window 2: Displays information in a graph form>

This type of window displays input/output terminal information and a life alarm in a graph form. (Ex. “Input terminal : S4, S3...R, F”)

It displays the ON/OFF status of each terminal signal and the ON/OFF status of an alarm signal in a graph form.

If the arrow ↑ is moved to a terminal or alarm symbol, the name of the function assigned to the terminal or the name of the alarm is displayed.

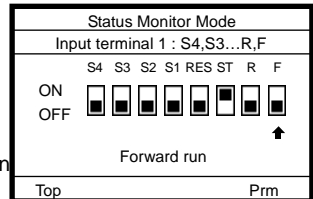

* This illustration shows the information displayed when the LCD panel is connected to an VF-AS1 inverter.

<Type of window 3: Displays information in a list form>

This type of window displays detailed trip information. (Ex. Past trip # 1 (latest))

It displays the conditions under which the inverter was operated at the occurrence of tripping.

Past trip # 1 (latest)	
E	:Emergency stop
Sequence number	1
Output frequency	25.0Hz
Rotative direction	FWD
Frequency reference	30.0Hz
Output current	40%
Top	Prm

8. Operation in a copy function

The copy function can be used when "Copy" is displayed on the upper part of the F3 key. The copy function works by the latest combination of LCD Remote Keypad (RKP004Z rev.2 or later) with the Inverter version of APP-CPU is V136 or more of VFAS1, V614 or more of VFPS1. When either is old, this function does not work.

Limitation in copy function use		Version of APP-CPU			
		VFAS1		VFPS1	
		V134 or less	V136 or more	V612 or less	V614 or more
LCD type form	RKP004Z-1or0	Disabled	Disabled	Disabled	Disabled
	After RKP004Z-2	Disabled	Enabled	Disabled	Enabled

Moreover, it is not possible to copy normally in the following cases even if the copy function can be used.

- 1) It is not possible to copy, when the inverter form differs,.
- 2) It is not possible to copy to the inverter while driving.
- 3) It is not possible to copy, when a minimum unit of the frequency is different.
- 4) It is necessary to reset up the parameters after the copy when copying between the inverters from which capacity differs.
- 5) It is necessary to reset power supply after the copy when the unit of time differs.

■ Explanation of the top window

- Display of commands executed:
"FWD" or "REV" is displayed to indicate the direction of rotation.
The operation frequency is displayed in the form of "□□. □Hz."
- Display of operating status:
"RUN" is displayed during operation.
"STOP" is displayed during a stop.
"Trip" is displayed in the event of tripping.
- Display of output frequency:
The operation frequency is displayed in the form of "□□. □Hz."
- Display of alarm/tripping:
If an error or tripping occurs, an error or trip code is displayed.
- Display of error/tripping message:
If an error or tripping occurs, an error or trip message is displayed

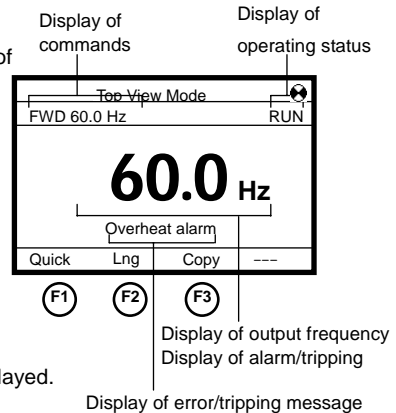

Functions of function keys

- (F1): Switches between Quick mode and Standard Setting mode
- (F2): Brings you to the Language selection window.
- (F3): Brings you to Copy mode window.

8. 1 Copy to LCD

Push the F3 key on an initial screen and the copy mode screen is displayed. It is not possible to drive with the [RUN] key in the following 3~5 screen display.

- 1 Select the memory saving group using the control dial.**

Copy Mode
Group selection <input type="checkbox"/>
Memory - A
Memory - B
Top Info <input type="checkbox"/>

- 2 Select copy direction [Copy to the LCD memory] using the control dial.**

Copy Mode
Memory - A
Copy direction <input type="checkbox"/>
[Copy to the inverter]
[Copy to the LCD memory]
Top <input type="checkbox"/>

- 3 Display of copy waiting**

Copy starts when the [F4] key is input.

Copy Mode
Memory - A
[Copy to the LCD memory]
Waiting
Please push F4 key when starting
Top Start

(F4)

- 4 Display of copy loading (fixed screen)**

Copy finishes in 1 minute. When the copy is not completed even if it waits 2 minutes or more, please reset a power supply and copy again.

Copy Mode
Memory - A
[Copy to the LCD memory]
Loading
Now loading. Please wait for about 1 min.

Note) The status display (🌀) doesn't rotate when copying it while driving until the copy is completed.

- 5 Display of copy finish**

Return to the copy direction window as above "2" when press the ESC key after copy.

Copy Mode
Memory - A
[Copy to the LCD memory]
Finish
Copy was completed normally. Please push ESC-key. CRC code : 6AE3
Top

8. 2 Copy to inverter

There is no data in LCD, and copy it to LCD at the time of purchase.

(Chap.: 8.1)

Push the F3 key on an initial screen and the copy mode screen is displayed. It is not possible to drive with the [RUN] key in the following 3~5 screen display.

1 Select the memory saving group using the control dial.

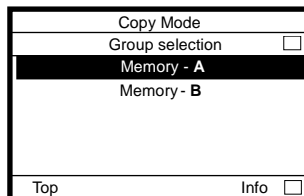

2 Select copy direction [Copy to the inverter memory] using the control dial.

It is not possible to copy to the inverter when there is no information in the selected memory. Copy to the LCD first (ref.: Chapter 8.1).

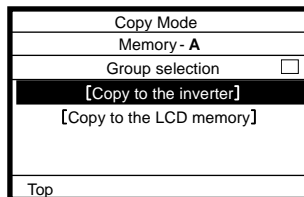

3 Display of copy waiting

Copy starts when the [F4] key is input

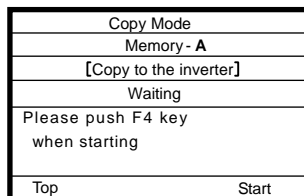

F4

4 Display of copy loading (fixed screen)

Copy finishes in 1 minute. . When the copy is not completed even if it waits 2 minutes or more, please reset a power supply and copy again.

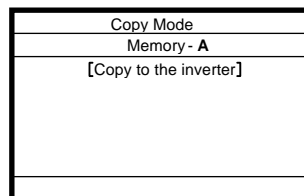

5 Display of copy finish

Return to the copy direction window as above "2" when press the ESC key after copy.

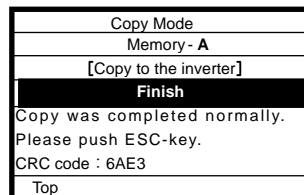

8.3 Confirm a memory information

There is no data in LCD, and copy it to LCD at the time of purchase.

(Chap.: 8.1)

Push the F3 key on an initial screen and the copy mode screen is displayed.

- 1 Select the memory saving group that you want to confirm using the control dial.**

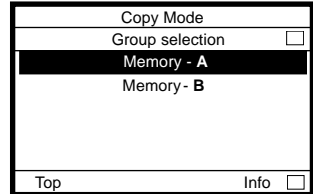

- 2 Push the [F4] key.**

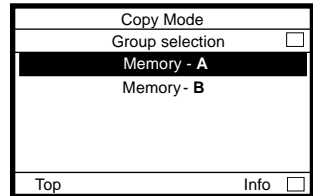

F4

- 3 Displays detail information in the LCD memory.**

Type : Displays VFAS1 or VFPS1.

Rating : Displays voltage and capacity.

Version of APP-CPU :

Displays CPU version for the application.

The total parameter might differ when CPU version is different.

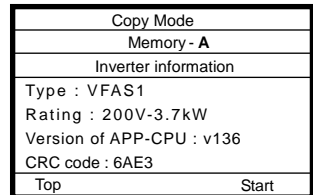

CRC code:

The CRC code is calculated from the communication data. It is detected whether it normally copies to the inverter by agreeing with the CRC in the memory code and the CRC in the copy completion display when copying it to the inverter.

9. List of function key functions

The abbreviations and graphic symbols displayed at the bottom of the window refer to the functions of function keys, and the pressing a function key performs the corresponding function. The abbreviations and graphical symbols in the window correspond to the [F1] to [F4] keys, respectively starting from the left.

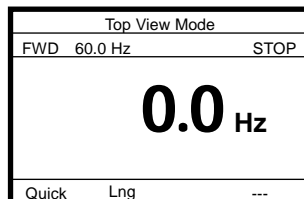

Press the [F1] key to perform this function.

Press the [F2] key to perform this function.

Press the [F3] key to perform this function.

Press the [F4] key to perform this function.

Here are the functions keys available and their functions.

Function key	Display		Function	Reference
	Display position	Item displayed		
[F1] key	Far left	Quick	Switches between Quick mode and Standard Setting mode.	5-2
		Panel	Switches between Operation Panel and Remote.	5-2
		Loc/Rem	Switches between Local and Remote.	5-2
		Update	Measurements for Peak/Minimum Hold starts.	5-2
		Top	Brings you to the Top View Mode.	4-1
		F9-- ~ F1--	Displays parameters in the number range of 900 ~ displays parameters in the number range of 100.	6-3
		x1000	Selects the position of hundreds.	5-1
[F2] key	Left center	Lng	Brings you to the Language selection window.	5-4
			Displays the previous window.	6-1
		x100	Selects the position of tens.	5-1
[F3] key	Right center		Displays the next window.	6-1
		x10	Selects the position of ones.	5-1
		Back	Displays, in reverse order, parameters whose setting were changed.	6-4
		Copy	Brings you to the copy mode.	8-1
		---	No function.	-
[F4] key	Far right	Mon	Brings you to the Top View Mode.	4-1
		Prm	Brings you to the Parameter Setup Mode.	4-1
		F1-- ~ F9--	Displays parameters in the number range of 100 ~ displays parameters in the number range of 900.	6-3
		x1	Selects the first decimal place.	5-1
		Next	Displays, in normal order, parameters whose setting were changed.	6-4
		JOG	Executes a jog run command.	5-5
		Info	Brings you to the memory information.	8-3
		---	No function.	-

10. Specifications

Item	Specifications
Model number	RKP004Z
Applicable model	VF-AS1/PS1 inverter unit
Communication setting	Baud rate: 19200 bps (F800=1) Communication type: 2-wire RS485 Parity: even (F801=1)
Use environments	Indoors, an altitude of 3000m or less, where the product will not be exposed to direct sunlight, corrosive or explosive gases, vapor, coarse particulates including dust, and where there is no grinding fluid or grinding oil nearby
Ambient temperature	-10 to +60°C
Storage temperature	-25 to +65°C
Relative humidity	20 to 93% (no condensation and absence of vapor)
Vibration	5.9m/s ² (0.6G) or less (10 to 55Hz) (compliant with JIS C 60068-2-6)
Cooling method	Self-cooling

■ Outside dimensions (unit: mm)

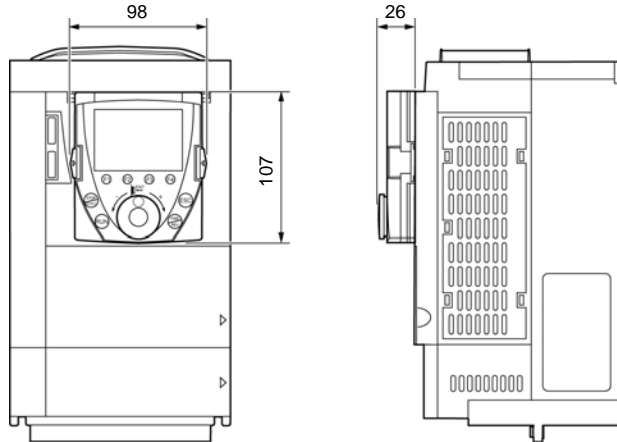

11. Before making a service call

If a problem occurs, follow the instructions in this table to track down and eliminate the cause of the problem.

Problems	Possible causes	Remedies
Nothing is displayed on the screen.	<ul style="list-style-type: none"> The inverter connected is not turned on or it is not connected securely. 	<ul style="list-style-type: none"> Check whether the inverter is turned on. Check the interconnect cable and the connector for loosening.
The Startup window appears, but the message "CONNECTION IN PROGRESS" does not out and the screen does not turn to the next window.	<ul style="list-style-type: none"> A cable other than a dedicated one is used. The communication speed setting or parity setting of the inverter is different from that of the unit. 	<ul style="list-style-type: none"> Use a dedicated cable. Set the communication speed and the parity, as specified below. F800 (communication speed) = 1 (19,200 bps) F801 (parity) = 1 (even parity) Then turn the unit off and then back on to reset it.
Although line information is displayed on the screen, textual information is not displayed. Or some characters are not displayed correctly.	<ul style="list-style-type: none"> Connection may be broken during communication. If the unit uses an old language database, the codes shown below may be displayed. <Ex.> "F123" "004" "M301" 	<ul style="list-style-type: none"> Move to another window by pressing the [ESC] key to reload textual information, and check the cable and the connector for loosening. This phenomenon does not mean that the unit is faulty.
The error code E-17 (key failure alarm) is displayed.	<ul style="list-style-type: none"> The same key is pushed more than 20 seconds. 	<ul style="list-style-type: none"> Check whether the key operates normally. If it does not operate normally, it has to be repaired.
Operation cannot be controlled with the [RUN] key or the [STOP/RESET] key.	<ul style="list-style-type: none"> Panel Operation mode is not enabled. The operation frequency is set at 0.0Hz. 	<ul style="list-style-type: none"> Change the setting of the basic parameter COMd (command input mode) to 1 (Panel / LCD-option). Set an operation frequency according to the setting of the basic parameter FMOd (frequency input mode 1). When performing operation at the frequency set with the extension operation panel (see section 5.1), set FMOd to 4 (Panel / LCD-option).
Operation can be controlled with the [RUN] key and the [STOP/RESET], but the direction of rotation cannot be changed with the [FWD/REV] key.	<ul style="list-style-type: none"> The basic parameter Fr (panel FWD/REV selection) is set to 0 or 1. 	<ul style="list-style-type: none"> Change the setting of the parameter Fr (panel FWD/REV selection) to 2 or 3.
The inverter has tripped because of a communication error (Err5).	<ul style="list-style-type: none"> F803 (com time-out time) is turned ON (enabled). * By default, the function of measuring the time for a time-out is turned off (disabled). 	<ul style="list-style-type: none"> Connection may be broken during communication. Check the cable and the connector for loosening.
Although the [STOP/RESET] key was not pressed, the machine stopped operating.	<ul style="list-style-type: none"> Multiple commands have been entered because the three keys [F2], [F3] and [F4] or [ESC], [FWD] and [RUN] were pressed in rapid succession. The [STOP/RESET] key may be broken and held in the ON position. 	<ul style="list-style-type: none"> Check to see if multiple commands have been entered as a result of pressing the three keys in rapid succession. Check whether the key operates normally. If it does not operate normally, it has to be repaired.

Problems	Possible causes	Remedies
Using a copy function is not possible.	<ul style="list-style-type: none"> • APP-CPU and the LCD type form may not be appropriate. 	<ul style="list-style-type: none"> • When APP-CPU and the LCD type form are not appropriate the copy function cannot be used.
Memory data error message is displayed.	<ul style="list-style-type: none"> • Something is wrong with the internal memory. 	<ul style="list-style-type: none"> • Copy to the LCD again. (ref. Chapter 8)
Disconnection error message is displayed when the copy function is used.	<ul style="list-style-type: none"> • Connection may be broken during communication. 	<ul style="list-style-type: none"> • Check the cable and the connector, then copy again.
"TOSHIBA" screen is momentarily displayed when using copy function or the confirmation of the memory information.	<ul style="list-style-type: none"> • This phenomenon appears only once when using copy function for the first time. 	<ul style="list-style-type: none"> • Does not appear after doing copy to the LCD one time(ref. Chapter 8.1).
"----" is displayed when using the confirmation of the memo information function.	<ul style="list-style-type: none"> • It occurs when LCD has no information or communication signal between LCD and the inverter is disconnected while copying to the LCD. 	<ul style="list-style-type: none"> • Copy to the LCD. (ref. Chapter 8)
The language cannot be selected.	<ul style="list-style-type: none"> • APP-CPU version of VFAS1 is less than V104. 	<ul style="list-style-type: none"> • The language can be selected by using APP-CPU version of VFAS1 is V106 or greater.

12. Warranty

Any part of the unit that proves defective will be repaired and adjusted free of charge under the following conditions:

1. If the product breaks down within one year after delivery, although it is installed and handled properly, and if the breakdown is undoubtedly attributable to a defect in designing or manufacturing by Toshiba, the product shall be repaired free of charge.
2. This warranty applies only to the delivered unit.
3. For the following kinds of failure or damage, the repair cost shall be borne by the customer even within the warranty period.
 - (1) Failure or damage caused by misuse, or unauthorized repairs or modification
 - (2) Failure or damage caused by the drop of the product after purchase or rough handling during transportation
 - (3) Failure or damage caused by fire, salty water or wind, corrosive gas, earthquake, storm or flood, lightning, abnormal voltage supply, or other natural disasters
 - (4) Damage caused by using the product for a purpose unauthorized for it as an external operation panel
4. If there are any warranty conditions otherwise provided for, those conditions will govern.