

**TOSVERT VF-AS1/PS1 series**

---

**Modbus TCP option unit Function Manual**

---

**MBE001Z**

---

**NOTICE**

1. Make sure that this instruction manual is delivered to the end user of Modbus TCP option unit.
2. Read this manual before installing or operating the Modbus TCP option unit. Keep it in a safe place for reference.
3. All information contained in this manual are subject to change without notice. Please confirm the latest information on our web site "[www.inverter.co.jp](http://www.inverter.co.jp)".



## Introduction

Thank you for purchasing the “Modbus TCP option (MBE001Z)” for the TOSVERT VF-AS1/PS1 inverter. Before using Modbus TCP option unit, carefully read and understand the safety precautions, this manual and the inverter instruction manual. This way you can utilize the excellent performance of this unit.





After reading this function manual, please keep it handy for future reference. For details of its general handling, see an instruction manual attached with the option unit.

- TOSVERT VF-AS1 Instruction Manual.....E6581301
- TOSVERT VF-PS1 Instruction Manual.....E6581386
- MBE001Z Instruction Manual .....E6581635

### ■ Handling in general

 <b>Warning</b>	
 Prohibited	▼ Do not connect or disconnect a network cable while the inverter power is on. It may lead to electric shocks or fire.
 Mandatory	▼ See the instruction manual attached with the option unit for cautions the handling. Otherwise, it may lead to electric shocks, fire, injuries or damage to product.

### ■ Network control

 <b>Warning</b>	
 Prohibited	▼ Do not send the value out of the valid range to network variables. Otherwise, the motor may suddenly start/stop and that may result in injuries.
 Mandatory	▼ Use an additional safety device with your system to prevent a serious accident due to the network malfunctions. Usage without an additional safety device may cause an accident.
 <b>Caution</b>	
 Mandatory	▼ Set up “Communication error trip function (see below)” to stop the inverter when the option unit is deactivated by an unusual event such as tripping, an operating error, power outage, failure, etc. - Time Out on Modbus Communication (f 594) (See “3.2.4 Network error detection”) Deactivated option unit may cause an accident, if the “Communication error trip function” is not properly set up. ▼ Make sure that the operation signals are STOP before resetting inverter’s fault. The motor may suddenly start and that may result in injuries.

### ■ Notes on operation

<b>Notes</b>	
	▼ When the control power is shut off by the instantaneous power failure, communication will be unavailable for a while.

# Table of Contents

<b>1. OVERVIEW .....</b>	<b>3</b>
<b>2. NAMES AND FUNCTIONS .....</b>	<b>3</b>
2.1. Outline .....	3
2.2. RJ45 connector pinout .....	4
2.3. Example of connection to a Modbus TCP .....	4
2.4. LED indicator .....	5
<b>3. PARAMETERS .....</b>	<b>6</b>
3.1. Communication parameters .....	6
3.2. The details of the parameter setting .....	8
3.2.1. DEVICE NAME (f 792-f 799) .....	8
3.2.2. Assigning IP addresses (f 576- f 588) .....	9
3.2.3. Assigning IP Master (f 589- f 592) .....	10
3.2.4. Network error detection (f 594, f 851, f 852) .....	10
3.2.5. IO Scanner (Command:f 831-f 838), (Monitor:f 841-f 848) .....	11
3.2.5.1. FA06 (Command word 1 from internal option PCB) .....	11
3.2.5.2. FA23 (Command word 2 from internal option PCB) .....	11
3.2.5.3. FA07 (Frequency reference from internal option PCB) .....	12
3.2.5.4. FA33 (Torque reference from internal option PCB) .....	12
3.2.5.5. FA50 (Terminal output data from comm.) .....	12
3.2.5.6. FA51 (Analog output (FM) data from comm.) .....	12
3.2.5.7. FA52 (Analog output (AM) data from comm.) .....	12
3.2.5.8. FD01 (Inverter status (real time)) .....	13
3.2.5.9. FD00 (Output frequency (real time)) .....	13
3.2.5.10. FD03 (Output current (real time)) .....	13
3.2.5.11. FE36 (Analog input value VI/II) .....	14
3.2.5.12. FE37 (RX Input) .....	14
3.2.5.13. FE60 - FE63 (My Monitor) .....	14
3.2.5.14. FE14 (Cumulative run time) .....	14
3.2.5.15. FE40 (Analog output (FM)) .....	14
3.2.5.16. FC91 (Alarm code) .....	14
3.2.5.17. FD06 (Input TB Status) .....	15
3.2.5.18. FD07 (Output TB Status) .....	15
<b>4. MODBUS TCP SERVER .....</b>	<b>16</b>
4.1. Modbus TCP frames .....	16
4.2. Drive Modbus servers .....	16
4.3. List of Modbus functions supported .....	16
4.4. "03 (03 Hex) Read Holding Registers" function .....	17
4.5. "06 (06 Hex) Write Single Register" function .....	18
4.6. "16 (10 Hex) Write Multiple Registers" function .....	19
4.7. "23 (17 Hex) Read/Write Multiple Registers" function .....	20
4.8. "43 (2B Hex) Read Device Identification" function .....	21
4.9. Parameter data .....	22
<b>5. IO SCANNING SERVICE .....</b>	<b>23</b>
5.1. Presentation .....	23
5.2. Periodic variables .....	23
<b>6. EXAMPLE OF THE SETUP WITH PL7 .....</b>	<b>24</b>
6.1. Defining the hardware configuration .....	24
6.2. BOOTP configuration .....	25
6.3. Configuring Modbus messaging .....	26
6.4. Configuring periodic variables .....	27
<b>7. COMMAND &amp; SETPOINT SELECTION (LOCAL/REMOTE) .....</b>	<b>28</b>
<b>8. UNUSUAL DIAGNOSIS .....</b>	<b>30</b>
8.1. Option error .....	30
8.2. Disconnection error of network cable .....	30

# 1. Overview

The Modbus TCP interface (MBE001Z) allows the VF-AS1/PS1 inverter to be connected into a Modbus TCP network.

MBE001Z is applicable for VF-AS1 (software version V150 or later) and VF-PS1 (software version V650 or later).

## 2. Names and functions

The drawing below shows names and functions of main parts.

### 2.1. Outline

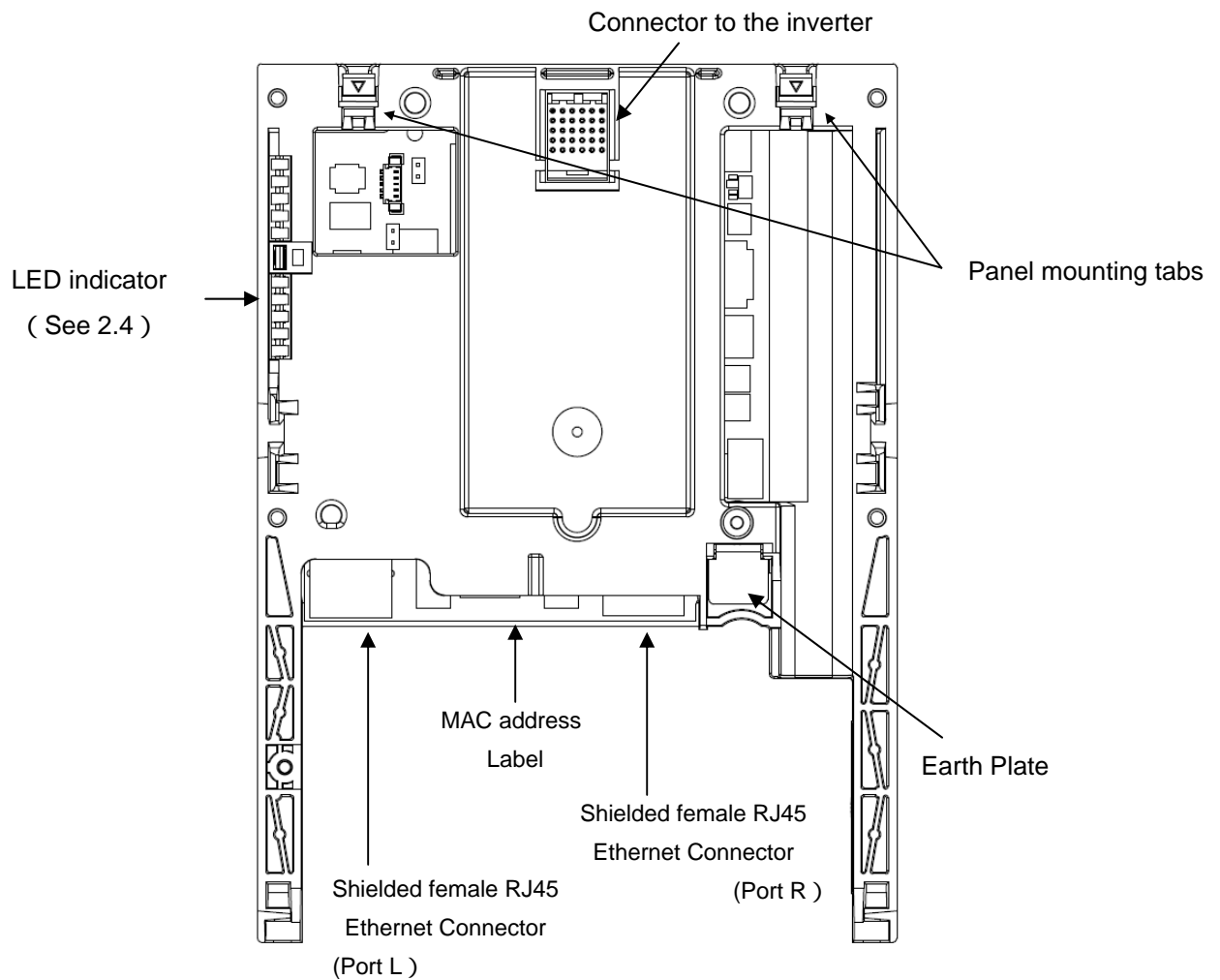

## 2.2. RJ45 connector pinout

The Modbus TCP card is equipped with two shielded RJ45 connectors. The shielding is connected to the drive ground.

Use a STP (shielded twisted pair) Ethernet cable

The transmission speed is detected automatically by the card (10 Mbps or 100 Mbps).

The card can operate in half duplex or full duplex mode, whether connected to a hub or a switch and regardless of the transmission speed (10 Mbps or 100 Mbps).

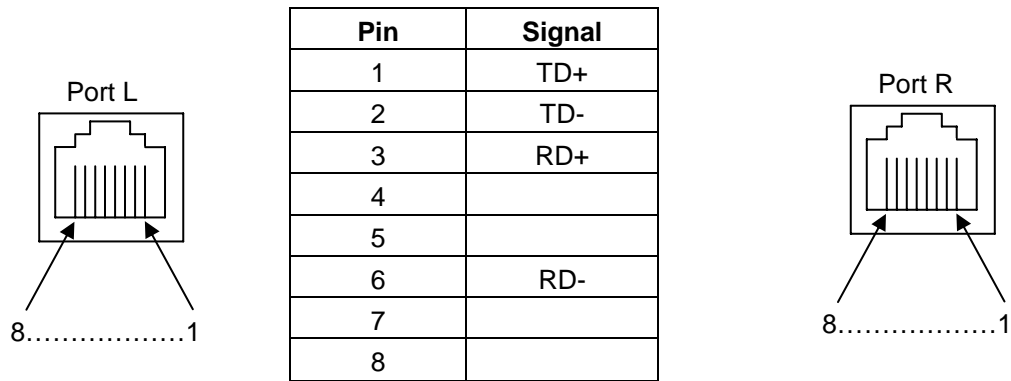

The card supports the ETHERNET 2 frame format (IEEE 802-3 not supported).

## 2.3. Example of connection to a Modbus TCP

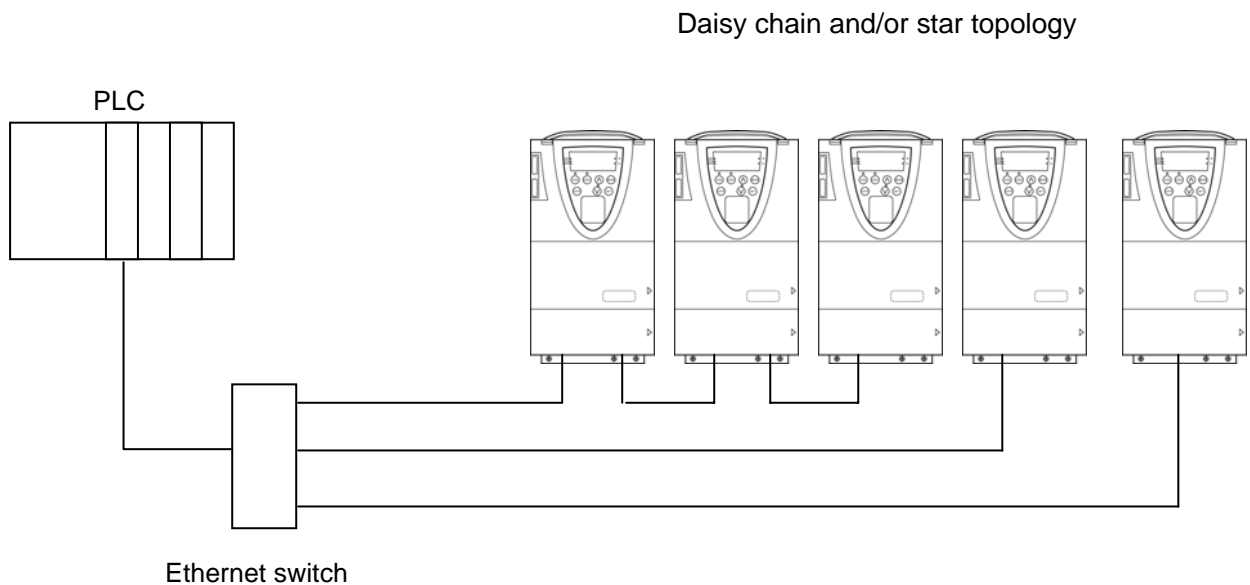

### Notes

- ▼ Provide strain relief so that the communication connector does not take the weight of the cable.
- ▼ Please connect this option to only the Modbus TCP communication line. This option does not work when connected to the other communication lines. For example, the RJ45 connector on the front of AS1/PS1 operation panel is for RS485 communication. Do not connect the Modbus TCP communication line to the RJ45 connector

## 2.4. LED indicator

The LED shows the present status of the network and error.

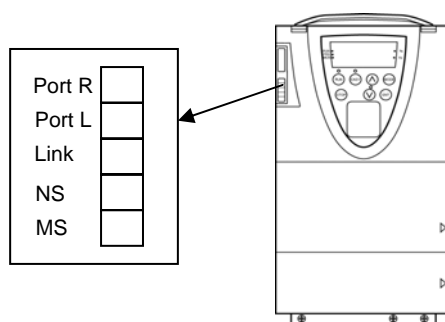

LED	Color/ state	Description
2.1 "Port R"	Off	No Link
	Flashing Green/Yellow	Power Up testing
	Green ON	Link at 100 Mbps
	Yellow ON	Link at 10 Mbps
	Green BLINK	Activity at 100 Mbps
	Yellow BLINK	Activity at 10 Mbps
2.2 "Port L"	Off	No Link
	Flashing Green/Yellow	Power Up testing
	Green ON	Link at 100 Mbps
	Yellow ON	Link at 10 Mbps
	Green BLINK	Activity at 100 Mbps
	Yellow BLINK	Activity at 10 Mbps
2.3 "Link"	Off	Physical connections unplugged - No IP address obtained
	Flashing Green/Red	Power Up testing
	Green ON	At least one port is connected and an IP address has been obtained
	Green flashing 3 times	All ports are unplugged, but the card has an IP address.
	Green flashing 4 times	Error: Duplicated IP address (1)
	Green flashing 5 times	The card is performing a BOOTP or DHCP sequence
2.4 "NS"	Off	The device does not have an IP address or powered off.
	Flashing Green/Red	Power up testing.
	Green ON	The device has at least one established connection (even to the Message Router.)
	Green flashing	The device has not established connections, but has obtained an IP address.
	Red flashing	One or more of the connections in which this device is the target has timed out. This shall be left only if all time out connections are reestablished or if the device is reset.
	Red ON	The device has detected that its IP address is already in use (1).
2.5 "MS"	Off	No power is supplied to the device.
	Flashing Green/Red	Power Up testing.
	Green ON	The device is operating correctly.
	Green flashing	The device has not been configured.
	Red flashing	The device has detected a recoverable minor fault.
	Red ON	The device has detected a non-recoverable major fault (1).

(1) In case of duplicate IP Address, the LED 2.3.is green flashing 4times, LED 2.4 and 2.5 are solid red.

## 3. Parameters

### 3.1. Communication parameters

Set up the inverter parameters as follows. These parameters do not take effect until the inverter is reset. If these parameters are not set to correct value, this unit can not work normally.

Title	Communication No.	Function	Description	Factory setting
f 821	0821	Rate Setting (*1)	This field is used to set the transmission speed and the transmission mode of the card. 0:Autodetect(default) 1:10Mbps Full 2:10Mbps Half 3:100Mbps Full 4:100Mbps Half	0
f 822	0822	Actual Rate (Port L)	This field displays the baud rate and the transmission mode currently used by the communication card. <b>(Display only)</b> 0:Autodetect 1:10Mbps Full 2:10Mbps Half 3:100Mbps Full 4:100Mbps Half	----
f 823	0823	Actual Rate (Port R)		
f 792- f 799	0792- 0799	DEVICE NAME (*1)	16 characters by a hex digit 0h to FFFFh for each of fields. (There are 2 characters per one parameter.) The device name is required if the card uses DHCP to obtain its IP Address. Refer to "3.2.1 DEVICE NAME" for the details.	0,0,0,0 0,0,0,0 (HEX) (*2)
f 576	0576	IP mode (*1)	Use this parameter to select the IP address assignment method. 0:Manual 1:BOOTP 2:DHCP Refer to "3.2.2 Assigning IP addresses" for the details.	0
f 577- f 580	0577- 0580	IP address (*1)	IP address of the card 0 to 255 for each of fields. These fields are editable when IP mode = 0. Refer to "3.2.2 Assigning IP addresses" for the details.	0,0,0,0
f 581- f 584	0581- 0584	IP Mask (*1)	Subnet mask of the card 0 to 255 for each of fields. These fields are editable when IP mode = 0. Refer to "3.2.2 Assigning IP addresses" for the details.	0,0,0,0
f 585- f 588	0585- 0588	IP Gate (*1)	Gateway IP address of the card 0 to 255 for each of fields. These fields are editable when IP mode = 0. Refer to "3.2.2 Assigning IP addresses" for the details.	0,0,0,0
f 589- f 592	0589- 0592	IP Master	0 to 255 for each of fields. • If the value is [0.0.0.0] then accepted by the Ethernet card regardless of which device has sent it. • If the value is other than [0.0.0.0] then only the device which has the IP address [IP Master] is authorized to write. Refer to "3.2.3 Assigning IP Master " for the details.	0,0,0,0
f 784- f 789	0784- 0789	MAC address	MAC address display 0 to 255 for each of fields.	----

Title	Communication No.	Function	Description	Factory setting
F594	0594	Time Out on Modbus Communication	0: No Time-Out (unit:1=0.1s) 1 to 600 (0.1s to 60.0s)	0
f851	0851	Operation at communication error by disconnection	0: Inverter stop, communication command, frequency mode open (by cmod, fmod) 1: None (continued operation) 2: Deceleration stop 3: Coast stop 4: Network error (error trip) 5: Preset speed operation (by f852 setting)	0
f852	0852	Preset speed operation selection	0:None 1~15:Preset speed operation (by parameter setting)	0
F593	0593	Enable IO Scanner	0: IO Scanner disabled 1: IO Scanner Enabled	0
f831 - f838	0831-0838	IO Scanner Command data	0: No action 1: FA06 (Communication option command 1) 2: FA23 (Communication option command 2) 3: FA07 (Communication option frequency command, 0.01Hz) 4: FA33 (Torque command, 0.01%) 5: FA50 (Terminal output) 6: FA51 (Analog output (FM) data from comm.) 7: FA52 (Analog output (AM) data from comm.) 8: F601 (Stall prevention level, %) 9: F441 (Power running torque limit 1 level, 0.01%) 10: F443 (Regenerative braking torque limit 1 level, 0.01%) 11: F460 (Speed loop proportional gain) 12: F461 (Speed loop stabilization coefficient)	0
f841 - f848	0841-0848	IO Scanner Monitor data	0: No action 1: FD01 (Inverter status 1) 2: FD00 (Output frequency, 0.01Hz) 3: FD03 (Output current, 0.01%) 4: FD05 (Output voltage, 0.01%) 5: FC91 (Inverter alarm) 6: FD22 (PID feedback value, 0.01Hz) 7: FD06 (Input terminal status) 8: FD07 (Output terminal status) 9: FE36 (VI/II input) 10: FE35 (RR/S4 input) 11: FE37 (RX input) 12: FD04 (Input voltage (DC detection), 0.01%) 13: FD16 (Speed feedback (real-time value)) 14: FD18 (Torque, 0.01%) 15: FE60 (My monitor) 16: FE61 (My monitor) 17: FE62 (My monitor) 18: FE63 (My monitor) 19: F880 (Free notes) 20: FD29 (Input power, 0.01kW) 21: FD30 (Output power, 0.01kW) 22: FE14 (Cumulative operation time, 0.01=1 hour) 23: FE40 (FM terminal output monitor) 24: FE41 (AM terminal output monitor)	0
f899	0899	Network option reset setting	0:None 1:Reset option circuit board and inverter	0
-	FE66	Add-on option 1 CPU version (Under side option)	High byte is version. Low byte is revision. For example, When version number 1, and revision number 2 is, panel indication becomes with 1.02.	-
-	FE67	Add-on option 2 CPU version (Panel side)	The version of the option with it has equipped can be checked by using the function of f710 to f718 (standard monitor display selection). *For details, refer to the inverter instruction manual.	-

(\*1): This parameter is effective by reset. Please reset (power supply reset or f899=1) after changing a set point.

(\*2): The Factory default setting parameter ( $\underline{L} \underline{Y} \underline{P}$ ) does not work for this parameter.



## 3.2. The details of the parameter setting

### 3.2.1. DEVICE NAME (f 792-f 799)

Device Name can be used by a hex digit to 16 characters

(DEVICE NAME (f 792-f 799) are 2 characters per one parameter.)

The device name is required if the card uses DHCP to obtain its IP Address.

Please set the setting of the device name according to the following rules.

1. The parameter is displayed by the hexadecimal number.
2. One parameter shows two ASCII characters.
3. The relation between the device name and the parameter is as follows.

Example for Device Name = 'VFAS1-4007'

Chars No.	Parameter	ASCII (Ex.)	Code (Ex.)	Setting data (Ex.)
1	f 792 (Upper byte (8-15bit))	'V'	54h	f 792 = 5446h
2	f 792 (Lower byte (0-7bit))	'F'	46h	
3	f 793 (Upper byte (8-15bit))	'A'	41h	f 793 = 4153h
4	f 793 (Lower byte (0-7bit))	'S'	53h	
5	f 794 (Upper byte (8-15bit))	'1'	31h	f 794 = 312Dh
6	f 794 (Lower byte (0-7bit))	'.'	2Dh	
7	f 795 (Upper byte (8-15bit))	'4'	34h	f 795 = 3430h
8	f 795 (Lower byte (0-7bit))	'0'	30h	
9	f 796 (Upper byte (8-15bit))	'0'	30h	f 796 = 3037h
10	f 796 (Lower byte (0-7bit))	'7'	37h	
11	f 797 (Upper byte (8-15bit))	' '	00h	f 797 = 0000h
12	f 797 (Lower byte (0-7bit))	' '	00h	
13	f 798 (Upper byte (8-15bit))	' '	00h	f 798 = 0000h
14	f 798 (Lower byte (0-7bit))	' '	00h	
15	f 799 (Upper byte (8-15bit))	' '	00h	f 799 = 0000h
16	f 799 (Lower byte (0-7bit))	' '	00h	

### 3.2.2. Assigning IP addresses (f 576 - f 588)

The drive needs 3 IP addresses.

\*The drive IP address.

\*The subnet mask.

\*The gateway IP address.

These fields are editable when IP mode (f 576) = 0.

If the address has been given by a BOOTP or a DHCP server, these fields are read only.

- If you enter a value other than [0.0.0.0], dynamic addressing by a BOOTP or DHCP server is disabled.
- After dynamic addressing by a BOOTP or DHCP server, the new address value is displayed.

They can be provided by:

\*A BOOTP server (correspondence between the MAC address and the IP addresses).

\*Or a DHCP server (correspondence between Device Name and IP addresses).

If an IP address other than [0.0.0.0] has been entered, assignment using a server is disabled.

The address is assigned according to the IPmode parameter.

IP Mode (f 576) value	Comments
IP mode = 0	The card uses the address defined in f 577 - f 588
IP mode = 1	The card receives its address from a BOOTP server
IP mode = 2 And Device name contains a valid name.	The card receives its address from a DHCP server

### 3.2.3. Assigning IP Master (f 589- f 592)

It is strongly recommended that control should be reserved for a single master device.

If control were not to be reserved for a master device (for example a PLC):

- Any other Modbus TCP Ethernet client could send unwanted commands.
- Other clients could use the 8 available TCP connections and prevent the master from having control.

#### **Warning**



Mandatory

- ▼ Use the [IP MASTER] (f 589- f 592) parameter to configure a network master device. If a valid IP address for a master device is not specified using this option, other Ethernet clients can saturate the TCP connections or send incorrect commands leading to unintended equipment operation.

Failure to follow this instruction can result in death, serious injury, or equipment damage

To configure this reservation, enter an IP address other than [0.0.0.0] (0) (0) (0) (0) .

• **If control has been reserved:**

All access to write from other IP addresses is not accepted (for example, adjustments or writing a setpoint).

2 TCP connections are reserved for this device. In this way, you avoid other TCP clients using all the available connections

(8 maximum) and the control master therefore no longer being able to access the drive Modbus TCP server.

When another device attempts to write :

- The response is error 4 (See 4.7 from 4.5)

• **If control has not been reserved (IP Master (f 589- f 592) = [0.0.0.0] ) :**

All access to write from any IP address is accepted.

### 3.2.4. Network error detection (f 594, f 851, f 852)

Set the network communication loss action time to f 594. The network loss action function starts from receiving the properly frame message. The action of the network communication loss is set by f 851 .

When setting of f 851 is set other than 4 when it was detected, 't' alarm occurs with the inverter. In addition, in the case of f 851 = 5, it runs at designated frequency in "Preset speed operation selection(f 852)".

#### **Caution**



Mandatory

- ▼ Set up "Network error detection" to stop the inverter when the option unit is deactivated by an unusual event such as an operating error, power outage, failure, etc. Deactivated option unit may cause an accident, if the "Network error detection" is not properly set up.

### 3.2.5. IO Scanner (Command:f 831-f 838), (Monitor:f 841-f 848)

The outline is indicated about the setting item of parameter IO Scanner Command data (f 831 - f 838), and IO Scanner Monitor data (f 841 - f 848). Please refer to a communication functional description (VF-AS1: E6581315/VF-PS1: E6581413) for details.

#### 3.2.5.1. FA06 (Command word 1 from internal option PCB)

bit	Function	0	1	Note
0	Preset Speed1	OFF ..... 0000, 1 - 15 ..... 0001 - 1111		Combination of 4 bits.
1	Preset Speed2			
2	Preset Speed3			
3	Preset Speed4			
4	THR1/2	Motor 1 (THR1)	Motor 2 (THR2)	THR1: t h r THR2: f 1 7 3
5	PI off	Normal	PI off	-
6	ACC1/ACC2	ACC 1 (AD1)	ACC 2 (AD2)	AD1: a c c , d e c AD2: f 5 0 0 , f 5 0 1
7	DC braking	OFF	DC braking	-
8	Jog	OFF	JOG RUN	-
9	Fw/Reverse	Fw.	Rev.	-
10	Run/stop	STOP	RUN	-
11	Free run (ST)		Free run	-
12	Emergency stop	OFF	EMG./ Stop	Always enable
13	Reset trip	OFF	Reset	-
14	Frequency link	OFF	Priority	Enable in spite of the parameter f mod
15	Command link	OFF	Priority	Enable in spite of the parameter c mod

#### 3.2.5.2. FA23 (Command word 2 from internal option PCB)

bit	Function	0	1	Note
0	Speed/Torque	Speed Ctrl.	Torque Ctrl.	-
1	Clear kwh	OFF	Clear	Clear the value of f e 7 6 , f e 7 7
2	(Reserved)	-	-	-
3 *	Brake Close (BC)	Normal	Forced Close	-
4 *	Pre magnetic	Normal	ON	-
5 *	Brake Open (B)	Brake Close	Brake Open	-
6 *	Brake Answer (BA)	Brake Close	Brake Open	-
7	Fast Stop	Normal	ON	-
8	ACC1/ACC2	00: Acc. / Dec. 1 01: Acc. / Dec. 2 10: Acc. / Dec. 3 * 11: Acc. / Dec. 4 *		Combination of 2 bits. AD1: a c c , d e c AD2: f 5 0 0 , f 5 0 1 AD3: f 5 1 0 , f 5 1 1 * AD3: f 5 1 4 , f 5 1 5 *
9	ACC3/ACC4 *			
10	THR 1/2	00: V/f 1 01: V/f 2 10: V/f 3 * 11: V/f 4 *		Combination of 2 bits.
11	THR 3/4 *			
12 *	Torque Limit 1/2	00: Torque limit 1 01: Torque limit 2 10: Torque limit 3 11: Torque limit 4		Combination of 2 bits.
13 *	Torque Limit 3/4			
14 *	Speed Gain 1/2	Gain 1	Gain 2	Gain 1: f 4 6 0 , f 4 6 1 Gain 2: f 4 6 2 , f 4 6 3
15	(Reserved)	-	-	-

\* These functions are reserved in VF-PS1.

### 3.2.5.3. FA07 (Frequency reference from internal option PCB)

---

Frequency reference is set up in units of 0.01Hz using hexadecimal number format.  
 For example, when "Frequency reference" is set up to 80Hz, since the minimum unit is 0.01Hz,  
 $80 / 0.01 = 8000(\text{Dec}) = 1F40\text{h}(\text{Hex})$

### 3.2.5.4. FA33 (Torque reference from internal option PCB)

---

Torque reference is set up in units of 0.01% using hexadecimal number format.  
 For example, when "torque reference" is set up to 50%, since the minimum unit is 0.01%,  
 $50 / 0.01 = 5000(\text{Dec}) = 1388\text{h}(\text{Hex})$

### 3.2.5.5. FA50 (Terminal output data from comm.)

---

By setting up the data of the bit 0 - 6 of terminal output data (FA50) from communication, setting data (0 or 1) can be outputted to the output terminal.  
 Please select the functional number 92 - 105 as the selection (f 130 - f 138, f 168, f 169) of the output terminal function before using it.

bit	Output TB function name	0	1
0	Communication data 1 (Output TB select No.: 92, 93)	OFF	ON
1	Communication data 2 (Output TB select No.: 94, 95)		
2	Communication data 3 (Output TB select No.: 96, 97)		
3	Communication data 4 (Output TB select No.: 98, 99)		
4	Communication data 5 (Output TB select No.: 100, 101)		
5	Communication data 6 (Output TB select No.: 102, 103)		
6	Communication data 7 (Output TB select No.: 104, 105)		
7	-	-	-

### 3.2.5.6. FA51 (Analog output (FM) data from comm.)

---

The data set as the parameter FA51 can output to FM terminal.  
 The data adjustment range is 0 - 2047 (resolution: 11 bits).  
 Please select 31 (analog output for communication) as FM terminal meter selection parameter (f msl ) before using it.  
 Please refer to "Meter setting and adjustment" Section of the VF-AS1/PS1 instruction manual for details.

### 3.2.5.7. FA52 (Analog output (AM) data from comm.)

---

The data set as the parameter FA52 can output to AM terminal.  
 The data adjustment range is 0 - 2047 (resolution: 11 bits).  
 Please choose 31 (analog output for communication) as AM terminal meter selection parameter (amsl ) before using it.  
 Please refer to "Meter setting and adjustment" Section of the VF-AS1/PS1 instruction manual for details.

### 3.2.5.8. FD01 (Inverter status (real time))

bit	Function	0	1	Note
0	FL	No output	Under output	-
1	EMG	No fault	Under fault	The r t r y status and the trip retention status are also regarded as tripped statuses.
2	ALARM	No alarm	Under alarm	-
3	(Reserved)	-	-	-
4	tHr2(VF2+tH2)	Motor 1 (THR1)	Motor 2 (THR2)	THR1: t h r THR2: f 1 7 3
5	PI	PI enable	PI off	-
6	ACC1/ACC2	Acc./Dec. 1 (AD1)	Acc./Dec. 2 (AD2)	AD1: a c c , d e c AD2: f 5 0 0 , f 5 0 1
7	DC braking	OFF	DC braking	-
8	Jog	OFF	JOG RUN	-
9	Fw/Reverse	Fwd. RUN	Rev. RUN	-
10	Run/stop	STOP	RUN	-
11	Free run (ST)	ST=ON	ST=OFF	-
12	Emergency stop	No EMG. Stop	Under EMG. Stop	-
13	READY with ST/RUN			ST = ON and RUN = ON in addition to "ready for operation"*
14	READY without ST/RUN			-
15**	Local/Remote	Remote	Local	-

\* Ready for operation: Initialization completed, not a stop due to a failure, no alarm issued, not m o f f , not a forced stop due to I l , not a forced stop due to a momentary power failure.

\*\* This function is reserved in VF-AS1.

### 3.2.5.9. FD00 (Output frequency (real time))

The current output frequency is read in units of 0.01Hz using hexadecimal number format. For example, when the output frequency is 80Hz, 1F40h (hexadecimal number) are read.

Since the minimum unit is 0.01Hz,

$$1F40h \text{ (Hex)} = 8000(\text{Dec}) * 0.01 = 80 \text{ (Hz)}$$

The following parameters are also the same as this parameter.

- FD22 (Feedback value of PID (real time)) ..... Unit: 0.01Hz
- FD16 (PG feedback or Estimated speed (real time))..... Unit: 0.01Hz
- FD29 (Input power (real time))..... Unit: 0.01kW
- FD30 (Output power (real time)) ..... Unit: 0.01kW

### 3.2.5.10. FD03 (Output current (real time))

The output current is read in units of 0.01% using hexadecimal number format.

For example, when the output current of the rated current 4.8A inverter is 50% (2.4A), 1388h (hexadecimal number) is read.

Since the minimum unit is 0.01%,

$$1388h \text{ (Hex)} = 5000 \text{ (Dec)} * 0.01 = 50 \text{ (\%)}$$

The following parameters are also the same as this parameter.

- FD05 (Output voltage(real time)) ..... Unit: 0.01% (V)
- FD04 (Voltage at DC bus (real time)) ..... Unit: 0.01%(V)
- FD18 (Torque) ..... Unit: 0.01% (Nm)\*

\* When the motor information connected to the inverter set to the parameter (f 4 0 5 - f 4 1 5), torque monitor value "100%" is same as the rated torque of a motor in general.

### 3.2.5.11. FE36 (Analog input value VI/II)

---

The value inputted into the VI/II terminal is read.  
The value range is 0h to 2710h (0 to 100.00 %).

- FE35 (RR Input) is also the same as this parameter.

### 3.2.5.12. FE37 (RX Input)

---

The value inputted into the RX terminal is read.  
The value range is D8F0h to 2710h (-100.00 to +100.00 %).

### 3.2.5.13. FE60 - FE63 (My Monitor)

---

Refer to the function Manual (E6581335).

### 3.2.5.14. FE14 (Cumulative run time)

---

The operated cumulative time is read using hexadecimal number format.  
For example, when cumulative operation time is 18 hours, 12h (18 hours) is read.  
12h (Hex) = 18 (Dec., hour)

### 3.2.5.15. FE40 (Analog output (FM))

---

The output value of FM terminal is read.  
The value range is set to 0 to 10000 (2710h).

- FE41 (AM terminal output monitor) is also the same as this parameter.

### 3.2.5.16. FC91 (Alarm code)

---

bit	Function	0	1	Note
0	Over current alarm	Normal	Under alarm	"C" blinking
1	Inverter over load alarm	Normal	Under alarm	"I" blinking
2	Motor over load alarm	Normal	Under alarm	"l" blinking
3	Over heat alarm	Normal	Under alarm	"h" blinking
4	Over voltage alarm	Normal	Under alarm	"p" blinking
5	Under voltage of main power	Normal	Under alarm	-
6	(Reserved)	-	-	-
7	Under current alarm	Normal	Under alarm	-
8	Over torque alarm	Normal	Under alarm	-
9	OLr alarm	Normal	Under alarm	-
10	Cumulative run-time alarm	Normal	Under alarm	-
11	(Reserved)	-	-	-
12	(Reserved)	-	-	-
13	(Reserved)	-	-	-
14	Stop after instantaneous power off	-	Dec., Under stop	Refer to f 256 value
15	Stop after LL continuance time	-	Dec., Under stop	Refer to uvc value

**3.2.5.17. FD06 (Input TB Status)**

bit	TB Name	Function (Parameter)	0	1
0	F	Input TB Function select 1 (f 1 1 1)	OFF	ON
1	R	Input TB Function select 2 (f 1 1 2)		
2*	ST	Input TB Function select 3 (f 1 1 3)		
3	RES	Input TB Function select 4 (f 1 1 4)		
4	S1	Input TB Function select 5 (f 1 1 5)		
5	S2	Input TB Function select 6 (f 1 1 6)		
6	S3	Input TB Function select 7 (f 1 1 7)		
7	S4	Input TB Function select 8 (f 1 1 8)		
8	L1	Input TB Function select 9 (f 1 1 9)		
9	L2	Input TB Function select 10 (f 1 2 0)		
10	L3	Input TB Function select 11 (f 1 2 1)		
11	L4	Input TB Function select 12 (f 1 2 2)		
12	L5	Input TB Function select 13 (f 1 2 3)		
13	L6	Input TB Function select 14 (f 1 2 4)		
14	L7	Input TB Function select 15 (f 1 2 5)		
15	L8	Input TB Function select 16 (f 1 2 6)		

\* This function is reserved in VF-PS1.

**3.2.5.18. FD07 (Output TB Status)**

bit	TB Name	Function (Parameter)	0	1
0	OUT1	Output TB Function select 1 (f 1 3 0)	OFF	ON
1	OUT2	Output TB Function select 2 (f 1 3 1)		
2	FL	Output TB Function select 3 (f 1 3 2)		
3	OUT3	Output TB Function select 4 (f 1 3 3)		
4	OUT4	Output TB Function select 5 (f 1 3 4)		
5	R1	Output TB Function select 6 (f 1 3 5)		
6	OUT5	Output TB Function select 7 (f 1 3 6)		
7	OUT6	Output TB Function select 8 (f 1 3 7)		
8	R2	Output TB Function select 9 (f 1 3 8)		
9	R3	Output TB Function select 10 (f 1 6 8)		
10	R4	Output TB Function select 11 (f 1 6 9)		
11 - 15	-	-	-	-



---

## 4. Modbus TCP server

---

### 4.1. Modbus TCP frames

---

Modbus TCP frames consist of a header and a Modbus request.

**Header format:**

Byte	Description		Comments
0	Transaction identifier	high order	This identifier always equals 0.
1		low order	
2	Protocol identifier	high order	
3		low order	
4	Length of data	high order	Number of bytes in the Modbus request +1. The frame length is always less than 256 bytes, the value of the significant byte therefore equals 0.
5		low order	
6	Destination identifier (Unit ID)		
7	Modbus request function code		

The frame header returned by the VF-AS1/PS1 server is identical to that of the frame sent by the client.

---

### 4.2. Drive Modbus servers

---

The destination identifier (Unit ID) is used to access drive Modbus TCP servers:

Unit ID	Modbus TCP server	Accessible parameters
0-248	Variable speed drive	See the VF-AS1/VF-PS1 Manual.
255	IO Scanner	See the "IO Scanner" section.

---

### 4.3. List of Modbus functions supported

---

Function code	Modbus name	Description	Size of data
03	Read Holding Registers	Read N output words	63 words max.
06	Write Single Register	Write one output word	-
16 (10 Hex)	Write Multiple Registers	Write N output words	61 words max.
23 (17 Hex)	Read/Write Multiple Registers	Read/write N words	20/20 words max.
43 (2B Hex)	Read Device Identification	Identification	-

#### 4.4. “03 (03 Hex) Read Holding Registers” function

This Modbus request is used to read the values of a number (No. of Points) of adjacent words starting at the address indicated (Starting Address). The values read are restored one after another, at the end of the response (First Point Data      Last Point Data).

Request format:

Byte	Meaning
0	Function Code = <b>03h</b>
1	Starting Address Hi
2	Starting Address Lo
3	No. of Points Hi (0)
4	No. of Points Lo (1 - 125)

Response format:

Byte	Meaning
0	Function Code = <b>03h</b>
1	Byte Count (B = 2 × No. of Points)
2	First Point Data Hi
3	First Point Data Lo
...	.....
B	Last Point Data Hi
B+1	Last Point Data Lo

Exception response format:

Byte	Meaning
0	Function Code = <b>83h</b>
1	Exception Code = <b>01 (Illegal Function)</b> <b>02 (Illegal Data Address)</b> <b>03 (Illegal Data Value)</b>

### Notes

- ▼ If the communication number that doesn't exist is read, the option returns 8000h(HEX).

## 4.5. “ 06 (06 Hex) Write Single Register” function

This Modbus request is used to write a given value (Preset Data) to the address supplied (Register Address).

Request format:

Byte	Meaning
0	Function Code = <b>06h</b>
1	Register Address Hi
2	Register Address Lo
3	Preset Data Hi
4	Preset Data Lo

Response format:

Byte	Meaning
0	Function Code = <b>06h</b>
1	Register Address Hi
2	Register Address Lo
3	Preset Data Hi
4	Preset Data Lo

Exception response format:

Byte	Meaning
0	Function Code = <b>86h</b>
1	Exception Code = <b>01 (Illegal Function)</b> <b>02 (Illegal Data Address)</b> <b>03 (Illegal Data Value)</b> <b>04 (Slave Device Failure)</b>

### Notes

- ▼ As for the EEPROM parameter, first the data is written to RAM, after that the data is written to EEPROM. Some EEPROM parameters cannot be changed during the inverter is running.  
When write to EEPROM parameter that will change inverter status from stop to run, the inverter must be in the state that it cannot run.  
For example: To write to EEPROM, the inverter must open ST-CC. (display shows "OFF")  
If not, the data is only written to RAM.
- ▼ The Life of EEPROM is approximately 100,000 times. Avoid writing a command more than 100,000 times to the same parameter of the Inverter.
- ▼ Please access only parameters in document.

## 4.6. “ 16 (10 Hex) Write Multiple Registers” function

This Modbus request is used to write a number (No. of Registers) of adjacent words starting at a given address (Starting Address). The values to be written are supplied one after another (First Register Data Last Register Data).

Request format:

Byte	Meaning
0	Function Code = <b>10h</b>
1	Starting Address Hi
2	Starting Address Lo
3	No. of Registers Hi (0)
4	No. of Registers Lo (1 - 100)
5	Byte Count (B = 2 × No. of Registers)
6	First Register Data (Hi)
7	First Register Data (Lo)
...	.....
B+4	Last Register Data (Hi)
B+5	Last Register Data (Lo)

Response format:

Byte	Meaning
0	Function Code = <b>10h</b>
1	Starting Address Hi
2	Starting Address Lo
3	No. of Registers Hi (0)
4	No. of Registers Lo (1 - 100)

Exception response format:

Byte	Meaning
0	Function Code = <b>90h</b>
1	Exception Code = <b>01 (Illegal Function)</b> <b>02 (Illegal Data Address)</b> <b>03 (Illegal Data Value)</b> <b>04 (Slave Device Failure)</b>

### Notes

- ▼ As for the EEPROM parameter, first the data is written to RAM, after that the data is written to EEPROM. Some EEPROM parameters cannot be changed during the inverter is running. When write to EEPROM parameter that will change inverter status from stop to run, the inverter must be in the state that it cannot run. For example: To write to EEPROM, the inverter must open ST-CC. (display shows "OFF") If not, the data is only written to RAM.
- ▼ The Life of EEPROM is approximately 100,000 times. Avoid writing a command more than 100,000 times to the same parameter of the Inverter.
- ▼ Please access only parameters in document.

## 4.7. “23 (17 Hex) Read/Write Multiple Registers” function

The “Read/Write Multiple Registers” service is reserved for setting up the IO Scanning service (see “IO Scanning” section).

Request format:

Byte	Meaning
0	Function Code = <b>17h</b>
1	Read Starting Address Hi (00)
2	Read Starting Address Lo (00)
3	No. of Read Registers Hi (0)
4	No. of Read Registers Lo (1 - 9)
5	Write Starting Address Hi (00)
6	Write Starting Address Lo (00)
7	No. of Write Registers Hi (0)
8	No. of Write Registers Lo (1 - 9)
9	Byte Count (B = 2 × No. of Registers)
10	First Write Register Data (Hi)
11	First Write Register Data (Lo)
...	.....
B+8	Last Write Register Data (Hi)
B+9	Last Write Register Data (Lo)

Response format:

Byte	Meaning
0	Function Code = <b>17h</b>
1	Byte Count (Byte Count = 2 × Number of Points)
2	First Point Data of Read Hi
3	First Point Data of Read Lo
...	.....
B	Last Point Data of Read Hi
B+1	Last Point Data of Read Lo

Exception response format:

Byte	Meaning
0	Function Code = <b>97h</b>
1	Exception Code = <b>01 (Illegal Function)</b> <b>02 (Illegal Data Address)</b> <b>03 (Illegal Data Value)</b> <b>04 (Slave Device Failure)</b>

### Notes

- ▼ As for the EEPROM parameter, first the data is written to RAM, after that the data is written to EEPROM. Some EEPROM parameters cannot be changed during the inverter is running. When write to EEPROM parameter that will change inverter status from stop to run, the inverter must be in the state that it cannot run. For example: To write to EEPROM, the inverter must open ST-CC. (display shows "OFF") If not, the data is only written to RAM.
- ▼ The Life of EEPROM is approximately 100,000 times. Avoid writing a command more than 100,000 times to the same parameter of the Inverter.
- ▼ Please access only parameters in document.

## 4.8. “ 43 (2B Hex) Read Device Identification” function

The “Read/Write Multiple Registers” service is reserved for setting up the IO Scanning service (see “IO Scanning” section).

Request format:

Byte	Meaning	
0	Function Code = <b>2Bh</b>	<b>2Bh</b>
1	Type of MEI	0Eh
2	Read Device ID code	01: Basic 02: Regular 03: Extended
3	Object ID	0

Response format:

Byte	Meaning	With the MBE001Z card	
0	Function Code = <b>2Bh</b>	<b>2Bh</b>	
1	Type of MEI	0Eh	
2	Read Device ID code	01: Basic 02: Regular 03: Extended	
3	Conformity Level	2	
4	More Follows	0	
5	Next Object Id	0	
6	Number Of Objects	3 for Basic. 6 for Regular or Extended	
7	Obj 0 Id → <b>Vendor Name</b>	0	
8	Obj 0 length	7	
9-15	Obj 0 value	“TOSHIBA”	
16	Obj 1 Id → <b>ProductCode</b>	1	
17	Obj 1 length	9	
18-26	Obj 1 value	“Modbus TCP”	
27	Obj 2 Id → <b>Version</b>	2	
28	Obj 2 length	4	
29-32	Obj 2 value	“vXYZ”	
33	Obj 4 Id → <b>Product Name</b>	4	<b>Only for Regular and Extended</b>
34	Obj 4 length	7	
35-41	Obj 4 value	“TOSVERT”	
42	Obj 5 Id → <b>Model Name</b>	5	
43	Obj 5 length	15 maximum	
44-58	Obj 5 value	“XXXXXXXXXX...”	
59	Obj 6 Id → <b>UserApplicationName</b>	6	
60	Obj 6 length	20 maximum	
61-80	Obj 6 value	“XXXXXXXXXX...”	

Exception response format:

Byte	Meaning
0	Function Code = <b>ABh</b>
1	Exception Code = <b>01 (Illegal Function)</b> <b>02 (Illegal Data Address)</b> <b>03 (Illegal Data Value)</b>

## 4.9. Parameter data

It is explanation by the reference method of the list of parameters of the VF-AS1 / VF-PS1 series as follows. For communication purposes, see the parameter list on inverter's instruction manual regarding the communication number, adjustment range and so forth.

<Example of excerpts from the inverter's instruction manual>

Title	Communication No.	Function	Adjustment range	Minimum setting unit (Panel/Communication)	Default setting	Write during running	Reference
auh	-	History function		1/1	-	-	5.1
au1	0000	Automatic acceleration/deceleration	0:Deselect 1:Automatic setting 2:Automatic setting (during acceleration only)	1/1	0	Disabled	5.2
au2	0001	Automatic torque boost	0:Deselect 1:Automatic torque boost + auto-tuning 1	1/1	-	Disabled	5.3
				⋮	⋮		
dec	0010	Deceleration time 1	0.1~6000 sec.	0.1/0.1 *2	*1	Enabled	5.2
typ	0007	Factory default setting	0: - 1:50 Hz default setting 2:60 Hz default setting 3:Factory default setting ⋮ 10:Acceleration/deceleration time setting 0.01 sec.~600.0 sec. 11:Acceleration/deceleration time setting 0.1 sec.~6000sec.	1/1	-	Disabled	5.20
				⋮			

\*1: Default values vary depending on the capacity.  
\*2: Changing the parameter  $\frac{t}{4P}$  enables to set to 0.01 sec. (adjustment range: 0.01 - 600.0 sec.).

- (1) "Title" means the display on the inverter panel.
- (2) "Communication number" is affixed to each parameter that is necessary for designating the parameter for communication.
- (3) "Adjustment range" means a data range adjustable for a parameter, and the data cannot be written outside the range. The data have been expressed in the decimal notation. For writing the data through the communication function, take the minimum setting unit into consideration, and use hexadecimal system.
- (4) "Minimum setup unit" is the unit of a single data (when the minimum unit is "-", 1 is equal to 1). For example, the "minimum setup unit" of acceleration time ( $\frac{P}{L}$ ) is 0.01, and 1 is equal to 0.01s. For setting a data to 10 seconds, transmit 03E8h [ $10 \div 0.01=1000d=03E8h$ ] by communication.
- (5) Communication numbers "xxxAh" to "xxxFh" don't exist in VF-AS1/VF-PS1. Therefore, these communication numbers are skipped when read or write. For example:  
When the data of two words is read from ACC(0009h), 000Ah doesn't exist because of this specification.  
Consequently, in this case ACC(0009h) and DEC(0010h) are read.

## 5. IO Scanning service

### 5.1. Presentation

The IO Scanning service is used to exchange periodic I/O data between:

- A controller or PLC (IO Scanner).
- Devices (IO Scanning servers).

This exchange is usually performed by implicit services, thus avoiding the need to program the controller (PLC).

The IO Scanner periodically generates the Read/Write Multiple Registers (23 = 17(Hex)) request.

The IO Scanning service operates if it has been enabled in the PLC and the drive.

The drive parameters assigned to IO Scanning have been selected by default. This assignment can be modified by configuration.

The drive IO Scanning service can also be configured by the Ethernet card Modbus server.

When the IO Scanning service has been enabled in the VF-AS1/VF-PS1 drive:

- A TCP connection is assigned to it.
- The parameters assigned in the periodic variables are exchanged cyclically between the Ethernet card and the drive.
- The parameters assigned to the periodic output variables are reserved for IO Scanning. They cannot be written by other Modbus services, even if the IO Scanner is not sending its periodic output variables.

### 5.2. Periodic variables

Word Number	Output variables (written by IO Scanner)	Input variables (read by IO Scanner)
0	Reserved	Reserved
1	Scanner read word 1 – configurable(F831)	Scanner write word 1 – configurable(F841)
2	Scanner read word 2 - configurable(F832)	Scanner write word 2 - configurable(F842)
3	Scanner read word 3 - configurable(F833)	Scanner write word 3 - configurable(F843)
4	Scanner read word 4 - configurable(F834)	Scanner write word 4 - configurable(F844)
5	Scanner read word 5 - configurable(F835)	Scanner write word 5 - configurable(F845)
6	Scanner read word 6 - configurable(F836)	Scanner write word 6 - configurable(F846)
7	Scanner read word 7 - configurable(F837)	Scanner write word 7 - configurable(F847)
8	Scanner read word 8 - configurable(F838)	Scanner write word 8 - configurable(F848)
9-31	Reserved	Reserved

It is possible to configure the assignment of periodic variables 1 to 8.

Please refer to "parameter" about configurable.



Example of the setup with PL7

It is an example of the setup using PLC (PL7) made by Schneider electric as follows.

### 5.3. Defining the hardware configuration

Configure an Ethernet module, then configure the module so that it can communicate with the drive. The example shows a TSX Premium PLC equipped with a TSX ETY5102 module.

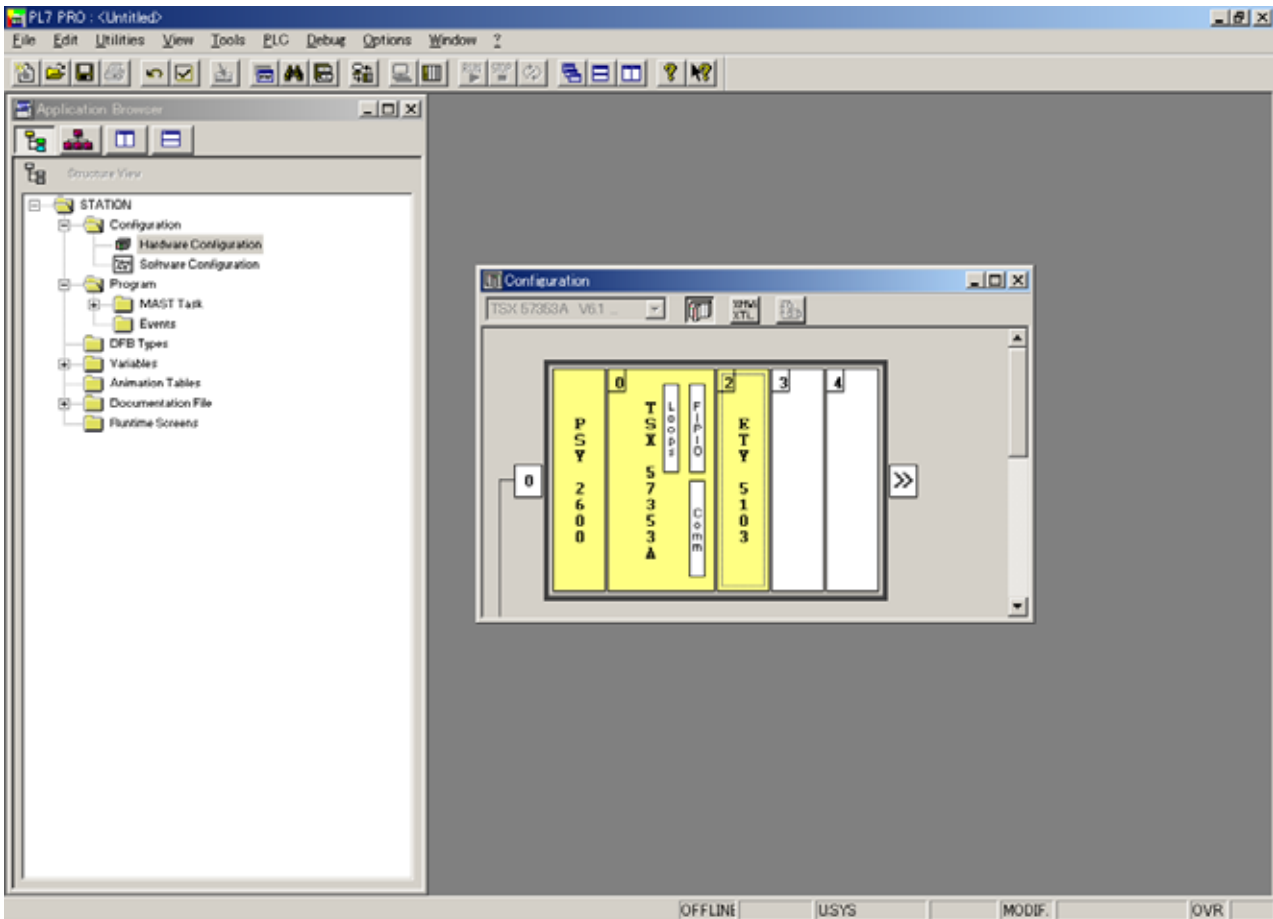

## 5.4. BOOTP configuration

The BOOTP server function consists of allocating BOOTP clients their IP addresses. The activation conditions for the drive BOOTP client are described in the “Configuration - IP Addresses” section.

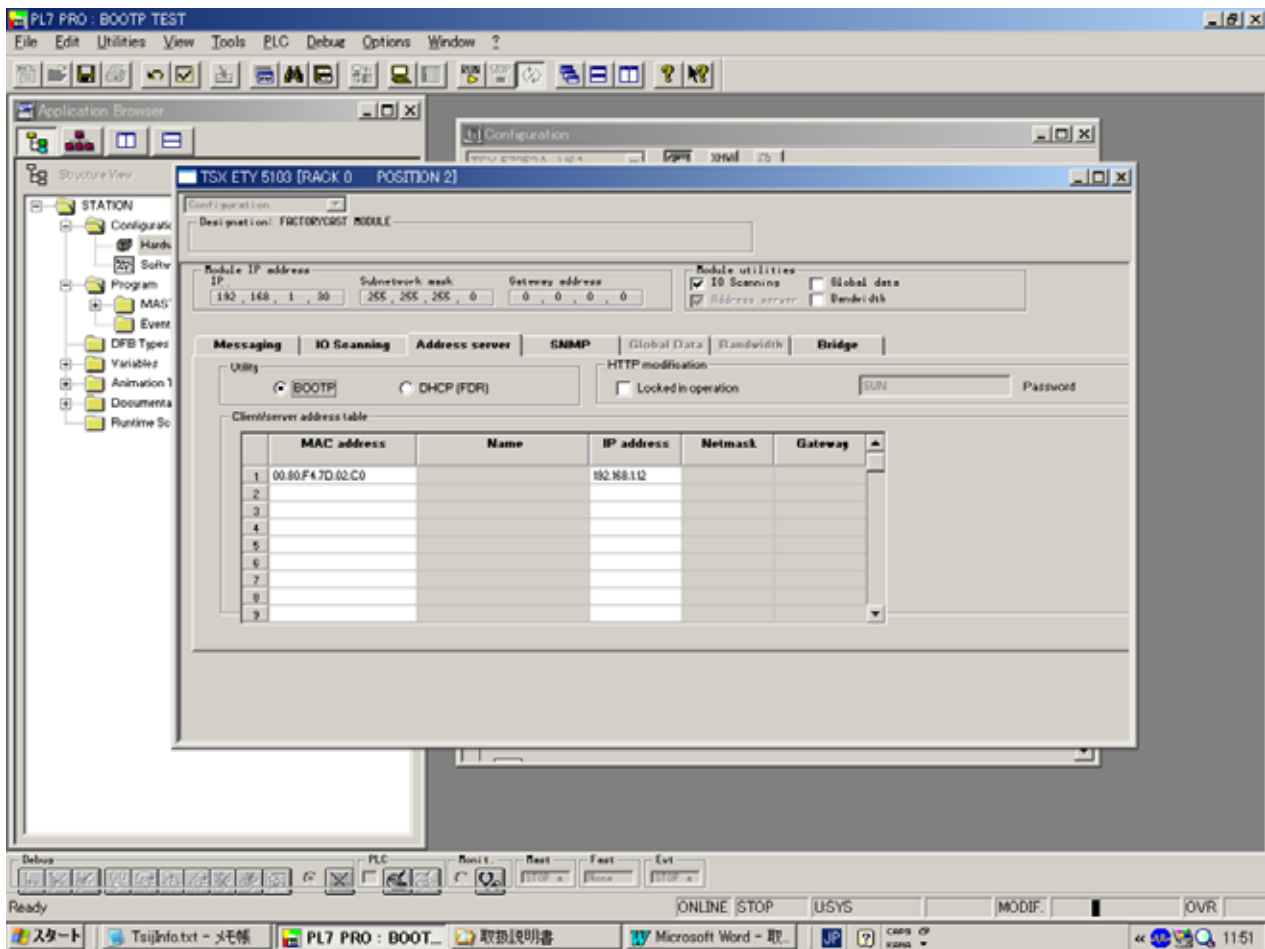

This window is used to configure the BOOTP server.

The drive MAC address is given on a label attached to its MBE001Z Ethernet card. The IP address assigned to the drive must be entered in the table against the MAC address. In this example, the Ethernet card MAC address is 00.80.F4.7D.02.C0, and its IP address is 192.168.1.12.

Each line in the “Table of supplied addresses” can accept both the MAC and IP addresses of a BOOTP client.

## 5.5. Configuring Modbus messaging

To use Modbus messaging in PL7, the “IP address”, “Subnet mask” and “Gateway address” parameters must be configured in the “Messaging” tab in the PLC Ethernet module configuration screen.

Data entered in the “Connection configuration” box is used to manage the PLC Modbus messaging service, but has no effect on IO Scanning which is an independent service.

Example:

PLC IP address	192.168.1.30
Subnet mask	255.255.255.0
Gateway address	0.0.0.0
Drive IP address	192.168.1.12

	Xway address	IP address	Protocol	Access	Mode
1	1,101	192.168.1.12	MODBUS	<input checked="" type="checkbox"/>	MULTI

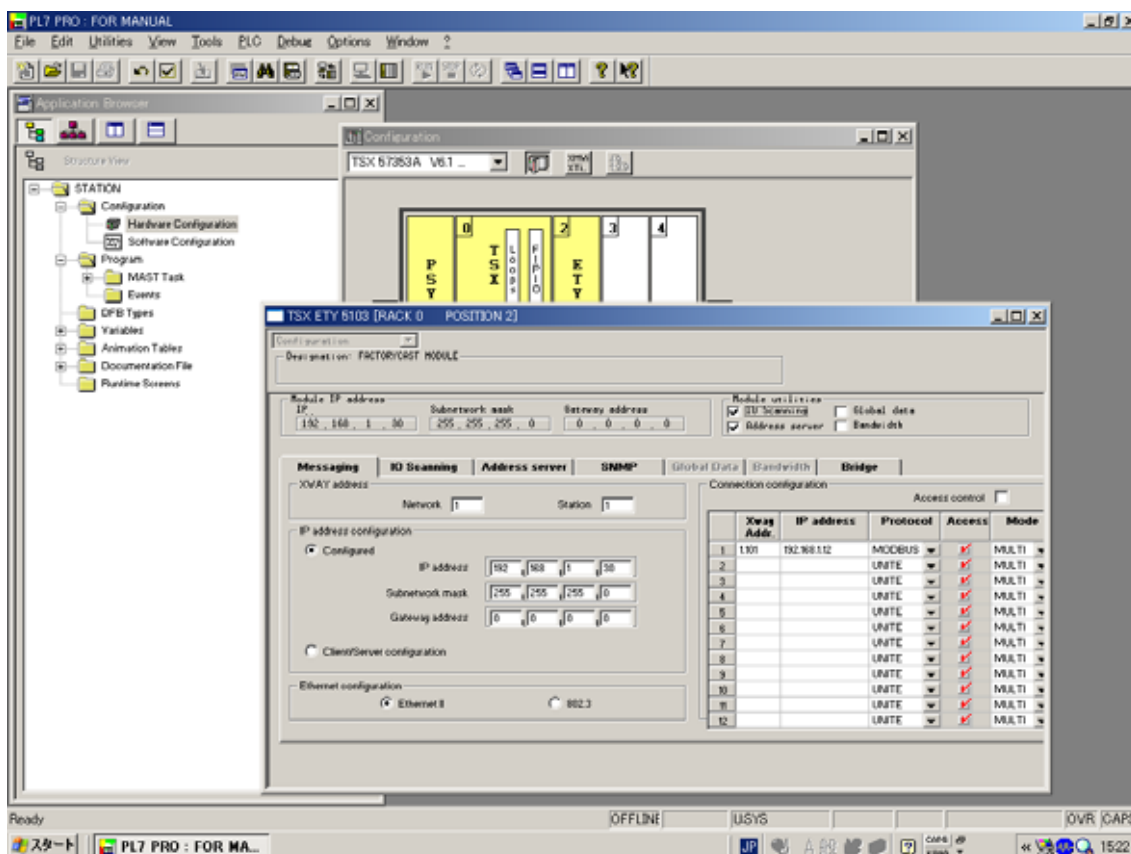

## 5.6. Configuring periodic variables

This window is used to configure the IO Scanning function, described in the IO Scanning Service section on page 23.

Example:

- The periodic variables of the drive at IP address 192.168.1.12 are associated with PLC data words.
- The drive periodic output variables (control) are associated with the 32 words (WR count) starting at PLC address %MW550 (Write Ref.).
- The drive periodic input variables (monitoring) are associated with the 32 words (RD count) starting at PLC address %MW500 (Read Ref.).

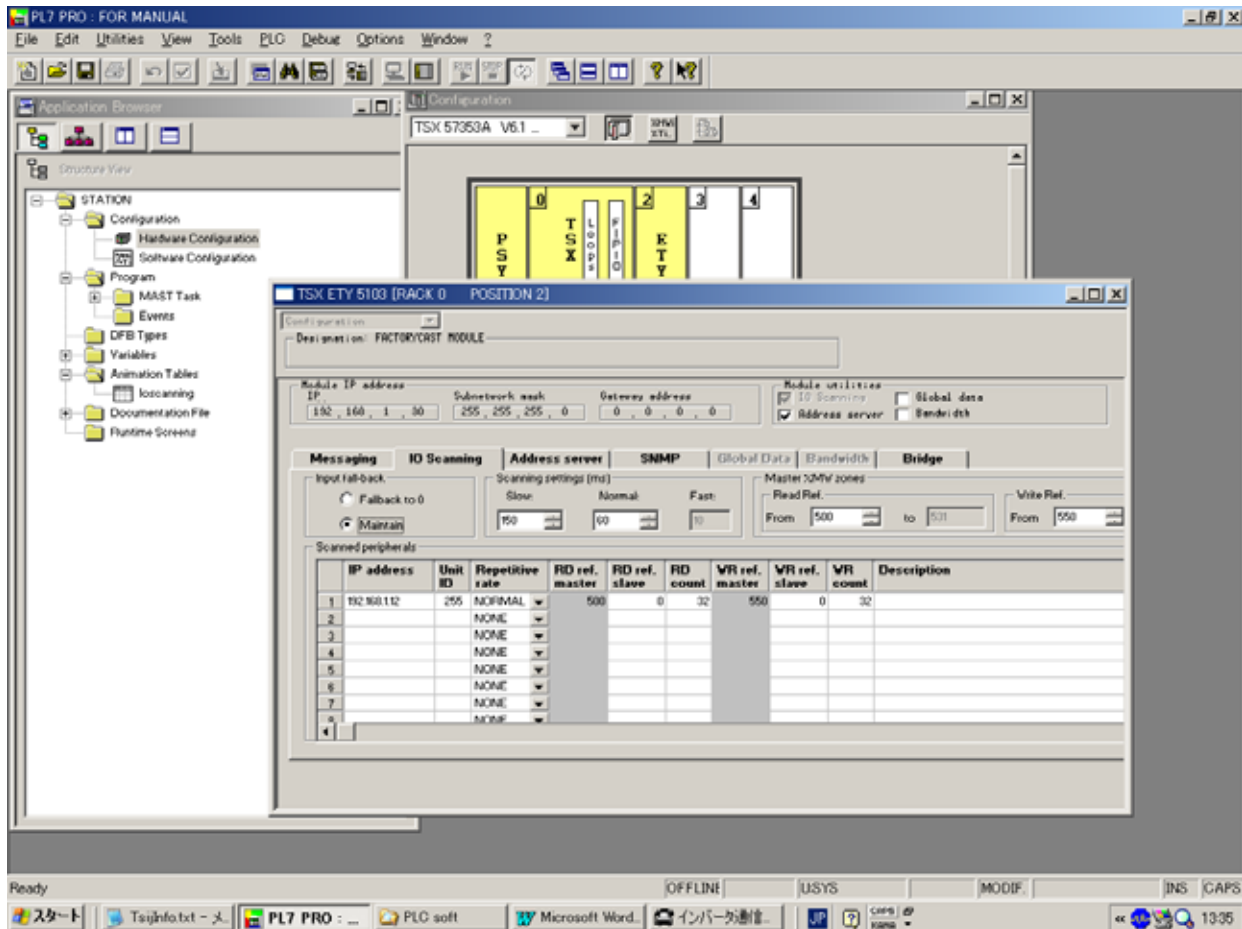

The addresses for the PLC %MW words correspond to the configuration in the previous example.

PLC address	Periodic output variable (default assignment)	Configurable
%MW 550	Reserved	No
%MW 551	Scanner write word 1	Yes (F831)
%MW 552	Scanner write word 2	Yes (F832)
%MW 553	Scanner write word 3	Yes (F833)
%MW 554	Scanner write word 4	Yes (F834)
%MW 555	Scanner write word 5	Yes (F835)
%MW 556	Scanner write word 6	Yes (F836)
%MW 557	Scanner write word 7	Yes (F837)
%MW 558	Scanner write word 8	Yes (F838)
%MW 559 to %MW 581	Reserved	No

PLC address	Periodic output variable (default assignment)	Configurable
%MW 500	Reserved	No
%MW 501	Scanner read word 1	Yes (F841)
%MW 502	Scanner read word 2	Yes (F842)
%MW 503	Scanner read word 3	Yes (F843)
%MW 504	Scanner read word 4	Yes (F844)
%MW 505	Scanner read word 5	Yes (F845)
%MW 506	Scanner read word 6	Yes (F846)
%MW 507	Scanner read word 7	Yes (F847)
%MW 508	Scanner read word 8	Yes (F848)
%MW 509 to %MW 531	Reserved	No

## 6. Command & Setpoint selection (Local/Remote)

Indication to display Local/Remote mode is on the inverter unit (Refer to the inverter instruction manual for details). Modbus TCP option command and setpoint are activated on Remote mode.

Inverters have some switches to select the command and setpoint location. Following figure shows the diagram. Refer to the inverter instruction manual for the parameter in detail.

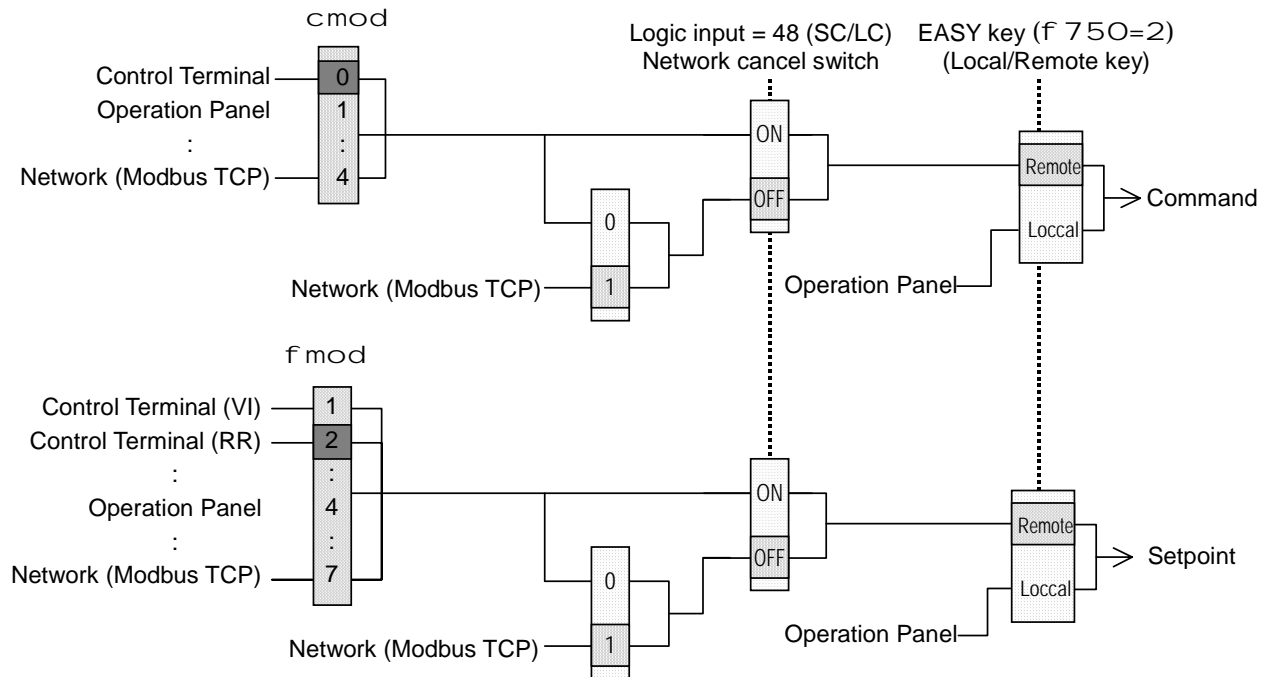

## &lt;Example&gt;

The example below shows how to configure the VF-AS1/PS1 for local/remote operation.

F terminal.....Operating command

R terminal .....Modbus TCP local/remote (Terminal in this example) switching

RR/S4 terminal.....Operation frequency command

## &lt;Wiring&gt;

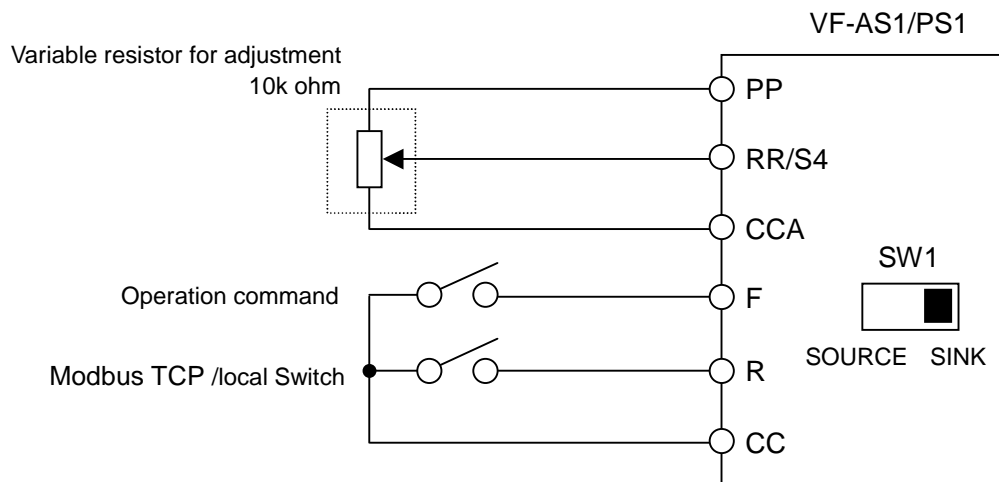

## &lt;Parameter setting&gt;

c mod(Command mode selection) = 0 (Terminal board)

f mod(Frequency setting mode selection 1) = 2 (RR/S4)

f 1 1 2(Input terminal selection 2 (R)) = 48 (Remote/Local control)

## &lt;Operation&gt;

R-CC terminal open: VF-AS1/PS1 is controlled as a slave device of The Modbus TCP.

R-CC terminal closed:

F-CC terminal short to RUN

F-CC terminal open to STOP

Output frequency is set up by the RR/S4 signal input.

## (Note)

When the local(HAND) / remote key (f 7 5 0=2) is chosen as EASY key selection and the EASY key lamp of an inverter front panel is on, priority is most given to operation by a panel. (Refer to the inverter instruction manual for details).

Note that the HAND mode of the panel has priority over FLN local control.

---

## 7. Unusual diagnosis

---

The VF-AS1/PS1 is able to install two kind options. The option error message is depended on the position of the option under or panel side.

---

### 7.1. Option error

---

The error message is displayed when there is hardware error, software error or lose of connection of wire.

When an option and a combination of the inverter are bad, it is displayed.

Please use VF-AS1 after V150 or VF-PS1 after V650.

Display of trip information

e - 23 (Error code : 55) : Add-on option 1 error

(This error is displayed at the time the bottom side option has an error or only one option is installed and has an error.)

e - 24 (Error code : 56) : Add-on option 2 error

(This error is displayed at the time the two-units are installed and the upper side option has an error.)

---

### 7.2. Disconnection error of network cable

---

When network trouble occurred by disconnection etc, the inverter does emergency stop with the following indication when the Time Out on Modbus Communication parameter (f 594) is set, and it was set in (f 851 =4).

Display of trip information

err 8 (Error code : 27) : Communication error.