TOSVERT VF-AS1/PS1 series

ModbusTCP option unit Instruction Manual

MBE001Z

NOTICE

1. Make sure that this instruction manual is delivered to the end user of Modbus TCP option unit.
2. Read this manual before installing or operating the Modbus TCP option unit. Keep it in a safe place for reference.
3. All information contained in this manual are subject to change without notice. Please confirm the latest information on our web site "www.inverter.co.jp".



Safety precautions

On the inverter and in its instruction manual, important information is contained to prevent injuries to users, damages to assets, and for proper use of the device.

Read the instruction manual provided with the inverter along with this instruction manual and thoroughly understand the safety precautions, the symbols, and indications as shown below.

Please adhere to the contents of these manuals at all times.



Explanation of markings

| Marking | Meaning of marking |
|---|---|
|  Warning | Indicates that errors in operation may lead to death or serious injury. |
|  Caution | Indicates that errors in operation may lead to injury (*1) to people or that these errors may cause damage to physical property. (*2) |

(*1) Such things as injury, burns or shock that will not require hospitalization or long periods of outpatient treatment.

(*2) Physical property damage refers to wide-ranging damage to assets and materials.





Meanings of symbols

| Marking | Meaning of marking |
|---|---|
|  | Indicates prohibition (Do not do it). What is prohibited will be described in or near the symbol in either text or picture form. |
|  | Indicates something mandatory (must be done). What is mandatory will be described in or near the symbol in either text or picture form. |
|  | Indicates danger or warning. What is dangerous, or what the warning should be applied to will be described in or near the symbol in either text or picture form. |



■ Limitation of use

| | |
|--|--|
| ⚠ Safety precaution | |
| <p>▼ Never use this unit with any device other than the TOSVERT VF-AS1/PS1 series inverters. Doing so may cause an accident.</p> | |



■ Handling in general

| | |
|--|---|
| ⚠ Warning | |
|  Never Disassemble | <p>▼ Never disassemble, modify or repair the product. Disassembling the product may cause electric shocks, fire, and injuries. For repairs, call your sales/repair agency.</p> |
|  Prohibited | <p>▼ Do not open the front cover on the inverter while the inverter power is on. It may lead to electric shocks.</p> <p>▼ Do not remove this option from VF-AS1/PS1 while the power is on. It may lead to electric shocks.</p> <p>▼ Do not put or insert foreign objects such as waste cable, bars or wires into the product. It may lead to electric shocks or fire.</p> <p>▼ Do not splash water over the product, and do not wipe the body with a wet cloth. It may lead to electric shocks or fire.</p> |
|  Mandatory | <p>▼ Turn off the power immediately in case of any abnormalities such as smoke, smell or abnormal noise. Neglect of these conditions may lead to fire. For repairs, call your sales/repair agency.</p> <p>▼ Do not touch the sharp portions (such as leads of parts on the board, the corner of board, or etc.) on this option. It may lead to injuries.</p> |
| ⚠ Caution | |
|  Mandatory | <p>▼ This option is an electrostatic discharge sensitive device. Handle it, where the environment is protected against electrostatic electricity. Otherwise, permanent damage to device will result.</p> |







■ Transportation and installation

| | |
|---|--|
| ⚠ Warning | |
|  Prohibited | <p>▼ Do not apply a dropping shock or other physical shocks. Otherwise, damage or malfunction will result.</p> <p>▼ Do not install or operate the inverter if it is damaged or any part of it is missing. Operating a defective inverter may lead to electric shocks or fire. For repairs, call your sales/repair agency.</p> <p>▼ Do not put any flammable material near the product. It may catch fire due to the product sparking in the case of a malfunction.</p> |
|  Mandatory | <p>▼ Use this product under the environmental conditions prescribed in the instruction manual. Usage it under any other conditions may result in malfunction.</p> <p>▼ An emergency stop device must be installed that fits with system specifications (e.g. shut off input power then engage mechanical brake). Operation cannot be stopped immediately by the inverter or this unit alone, thus risking an accident or injuries.</p> |



■ **Wiring**

|  Caution | |
|--|--|
|  Mandatory | <ul style="list-style-type: none"> ▼ Electrical construction work must be done by a qualified expert. Connection of input power by someone who does not have expert knowledge may result in electric shocks or fire. ▼ Turn off input power before wiring. Wait at least 15 minutes and make sure that the charge lamp (on the inverter unit) is no longer lit. Otherwise, it may lead to electric shocks. |

■ **Operations**

|  Warning | |
|--|--|
|  Prohibited | <ul style="list-style-type: none"> ▼ Do not pull on the cable and connector. It may cause damage or malfunctions. |
|  Mandatory | <ul style="list-style-type: none"> ▼ Use this option under the environment specified in the instruction manual. Usage under the environment other than them may cause damages or malfunctions or an accident. ▼ Use an additional safety device with your inverter or system to prevent a serious accident due to the unit malfunctions. Usage without an additional safety device may cause an accident. |
|  Mandatory | <ul style="list-style-type: none"> ▼ Use the [IP MASTER] (<i>F 5 8 9 - F 5 9 2</i>) parameter to configure a network master device. If a valid IP address for a master device is not specified using this option, other Ethernet clients can saturate the TCP connections or send incorrect commands leading to unintended equipment operation. Failure to follow this instruction can result in death, serious injury, or equipment damage |
|  Caution | |
|  Mandatory | <ul style="list-style-type: none"> ▼ Set up “Communication error trip function (see below)” to stop the inverter when the option unit is deactivated by an unusual event such as an operating error, power outage, failure, etc. <ul style="list-style-type: none"> - Time Out on Modbus Communication (<i>F 5 9 4</i>) (See the VF-AS1/PS1 ModbusTCP Communication Function Manual for details.) Deactivated option unit may cause an accident, if the “Communication error trip function” is not properly set up. ▼ Make sure that the operation signals are STOP before resetting inverter’s fault. The motor may suddenly start and that may result in injuries. |

■ **Disposal**

|  Caution | |
|--|--|
|  Mandatory | <ul style="list-style-type: none"> ▼ If you dispose off this unit, have it done by a specialist in industrial waste disposal*. Improper disposal may result in explosion of capacitors or produce noxious gases, resulting in injuries. (*) Persons who specialize in the processing of waste and known as “Industrial Waste Product Collectors and Transporters” or “Industrial Waste Disposal Persons.” If the collection, transport and disposal of industrial waste is done by someone who is not licensed for that job, it is a punishable violation of the law (Laws in regard to cleaning and processing of waste materials). |

■ **Notes on operation**

| Notes | |
|--------------|---|
| | <ul style="list-style-type: none"> ▼ Avoid installing in a place where ambient temperature or/and humidity change sharply. ▼ Keep the transmission cable separate from the power cable of the inverter to prevent the inverter from malfunction due to electromagnetic noise. |

Preface

Thank you for purchasing the “ModbusTCP option (MBE001Z)” for the TOSVERT VF-AS1/PS1 inverter. By installing this board into the VF-AS1/PS1, data communication can be made with a host computer or other device via ModbusTCP network.

Before using this unit, carefully read and understand the safety precautions, this manual and the inverter instruction manual. This way you can utilize the excellent performance of this unit. Besides this instruction manual, the “ModbusTCP option Function Manual” which includes the contents to install into ModbusTCP network is prepared. If it is required, please contact with our branch offices, sales offices or web site “www.inverter.co.jp”.

(“ModbusTCP option Function Manual”: E6581636)

After reading this instruction manual, please keep it handy for future reference.

*MBE001Z is applicable for VF-AS1(software version V150 or later) and VF-PS1(software version V650 or later).

- Part numbering

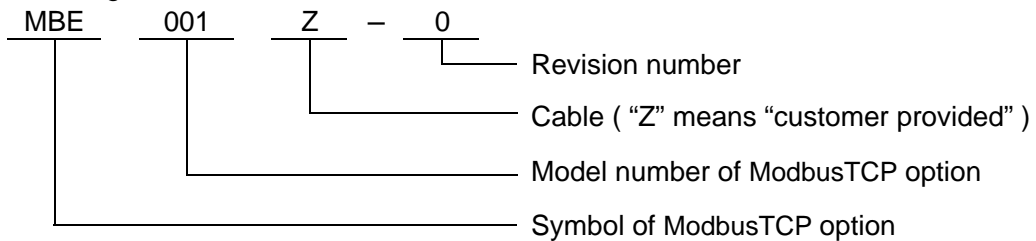

- Accessory check list

ModbusTCP communication option is shipped together with the following accessories. On opening the packing case, check to see if the following accessories are contained or not.

- (1) ModbusTCP option (MBE001Z)..... 1 board

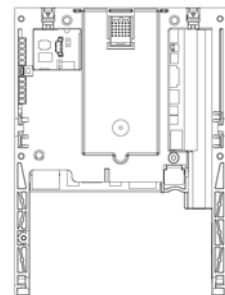

- (2) Instruction manual for the VF-AS1/PS1 ModbusTCP option.....1 copy

(English: E6581635
(This manual)

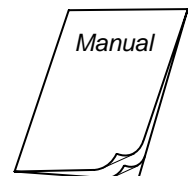

- (3) LED name label

1 sheet

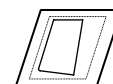

Table of Contents

| | |
|---|----|
| 1. Overview | 6 |
| 2. Names and functions..... | 6 |
| 2.1. Outline..... | 6 |
| 2.2. RJ45 connector pinout | 7 |
| 2.3. Example of connection to an ModbusTCP | 7 |
| 2.4. LED indicator..... | 8 |
| 3. Installing the MBE001Z | 9 |
| 4. Parameters..... | 10 |
| 4.1. Communication parameters | 10 |
| 5. Command & Setpoint selection (Local/Remote)..... | 12 |
| 6. Specifications | 14 |
| 7. Warranty..... | 14 |

1. Overview

The ModbusTCP interface (MBE001Z) allows the VF-AS1/PS1 inverter to be connected into a ModbusTCP network.

2. Names and functions

The drawing below shows names and functions of main parts.

2.1. Outline

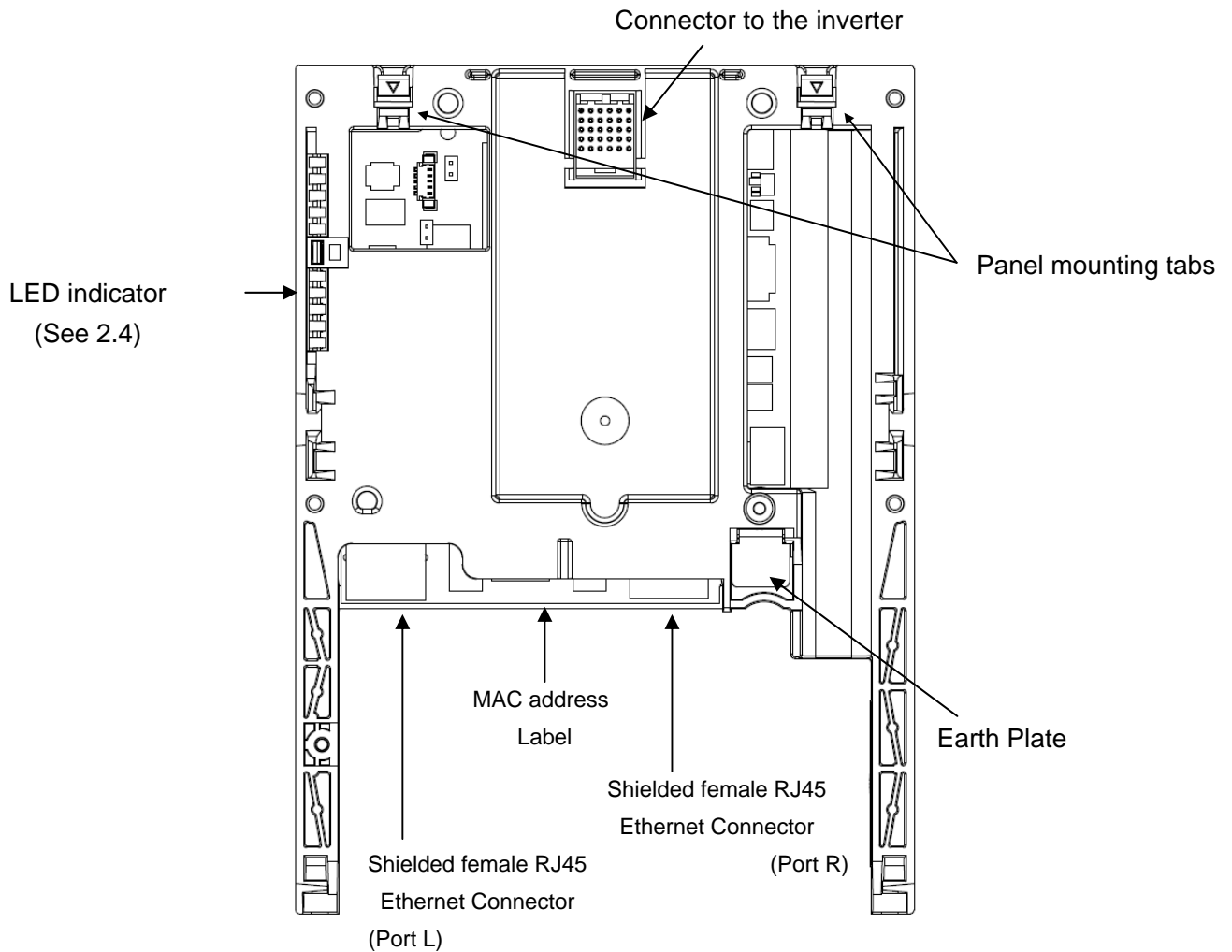

2.2. RJ45 connector pinout

The ModbusTCP card is equipped with two shielded RJ45 connectors. The shielding is connected to the drive ground.

Use a STP (shielded twisted pair) Ethernet cable

The transmission speed is detected automatically by the card (10 Mbps or 100 Mbps).

The card can operate in half duplex or full duplex mode, whether connected to a hub or a switch and regardless of the transmission speed (10 Mbps or 100 Mbps).

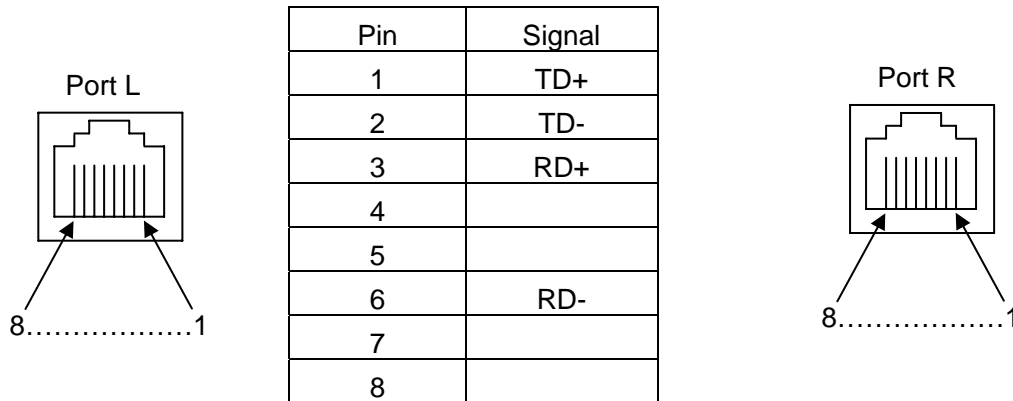

2.3. Example of connection to a ModbusTCP

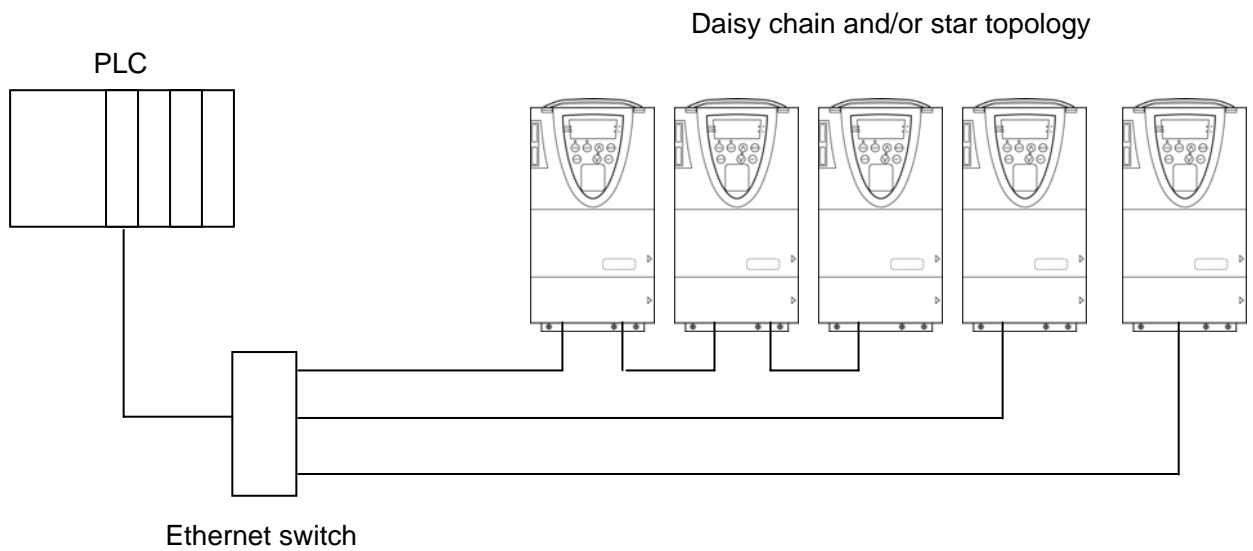

Notes

- ▼ Provide strain relief so that the communication connector does not take the weight of the cable.
- ▼ Please connect this option to only the Modbus TCP communication line. This option does not work when connected to the other communication lines. For example, the RJ45 connector on the front of AS1/PS1 operation panel is for RS485 communication. Do not connect the Modbus TCP communication line to the RJ45 connector

2.4. LED indicator

The LED shows the present status of the network and error.

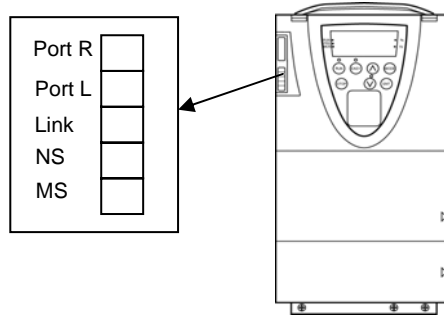

| LED | Color/ state | Description |
|-----------------|------------------------|---|
| 2.1 "Port R" | Off | No Link |
| | Flashing Green/Yellow | Power Up testing |
| | Green ON | Link at 100 Mbps |
| | Yellow ON | Link at 10 Mbps |
| | Green BLINK | Activity at 100 Mbps |
| | Yellow BLINK | Activity at 10 Mbps |
| 2.2 "Port L" | Off | No Link |
| | Flashing Green/Yellow | Power Up testing |
| | Green ON | Link at 100 Mbps |
| | Yellow ON | Link at 10 Mbps |
| | Green BLINK | Activity at 100 Mbps |
| | Yellow BLINK | Activity at 10 Mbps |
| 2.3 "Link" | Off | Physical connections unplugged - No IP address obtained |
| | Flashing Green/Red | Power Up testing |
| | Green ON | At least one port is connected and an IP address has been obtained |
| | Green flashing 3 times | All ports are unplugged, but the card has an IP address. |
| | Green flashing 4 times | Error: Duplicated IP address (1) |
| | Green flashing 5 times | The card is performing a BOOTP or DHCP sequence |
| 2.4 "NS" | Off | The device does not have an IP address or powered off. |
| | Flashing Green/Red | Power up testing. |
| | Green ON | The device has at least one established connection (even to the Message Router.) |
| | Green flashing | The device has not established connections, but has obtained an IP address. |
| | Red flashing | One or more of the connections in which this device is the target has timed out. This shall be left only if all time out connections are reestablished or if the device is reset. |
| | Red ON | The device has detected that its IP address is already in use (1). |
| 2.5 "MS" | Off | No power is supplied to the device. |
| | Flashing Green/Red | Power Up testing. |
| | Green ON | The device is operating correctly. |
| | Green flashing | The device has not been configured. |
| | Red flashing | The device has detected a recoverable minor fault. |
| | Red ON | The device has detected a non-recoverable major fault (1). |

(1) In case of duplicate IP Address, the LED 2.3.is green flashing 4times, LED 2.4 and 2.5 are solid red.

3. Installing the MBE001Z

Install the ModbusTCP option to VF-AS1/PS1 as follows.

| | |
|---|---|
|  Mandatory | Turn off the input power of VF-AS1/PS1 and wait for at least 15 minutes and then check that the CHARGE lamp on VF-AS1/PS1 is no longer lit. |
|---|---|

- (1) Turn off input power of VF-AS1/PS1 and wait for at least 15 minutes and then check that the CHARGE lamp on VF-AS1/PS1 is no longer lit.
- (2) Securing the option to the inverter
 - a) Insert a flat-blade screwdriver in each of the two holes at the upper part of the front panel, release the panel mounting tab by pushing the screwdriver down and remove the front panel cover.
 - b) Install the option in the inverter by fitting the tabs on the lower side the option into the slots at the lower part of the inverter front panel.
 - c) Make sure the option is securely attached to the inverter. Then check whether the plastic bosses on the inverter case have fitted in the holes at the upper and lower parts of the option.
 - d) Insert the tabs at the lower part of the front cover into the slots at the lower part of the inverter to attach the front cover to the inverter.
 - e) Stick the enclosed "LED name label" to the option LED display part of the front cover.

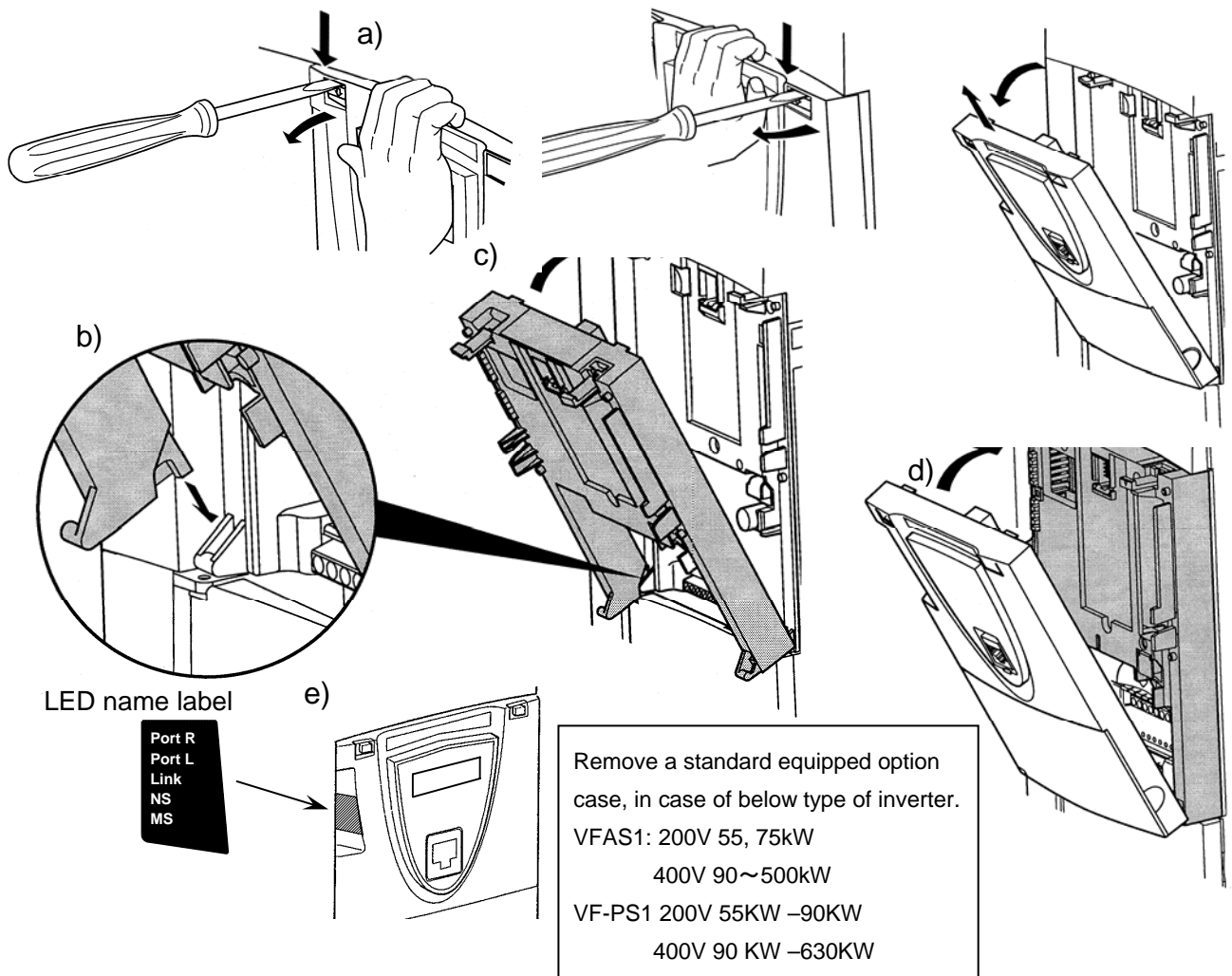

Case of installing two options

Please install this option (MBE001Z) on the top of options when you install two options. Do not install under the another option.

4. Parameters

4.1. Communication parameters

Set up the inverter parameters as follows. These parameters do not take effect until the inverter is reset. If these parameters are not set to correct value, this unit can not work normally.

| Title | Communication No. | Function | Description | Factory setting |
|--|-------------------|----------------------------------|---|-------------------------------------|
| <i>F821</i> | 0821 | Rate Setting (*1) | This field is used to set the transmission speed and the transmission mode of the card. 0:Autodetect(default) 1:10Mbps Full 2:10Mbps Half 3:100Mbps Full 4:100Mbps Half | 0 |
| <i>F822</i> | 0822 | Actual Rate (Port L) | This field displays the baud rate and the transmission mode currently used by the communication card. (Display only) 0:Autodetect 1:10Mbps Full 2:10Mbps Half 3:100Mbps Full 4:100Mbps Half | 0 |
| <i>F823</i> | 0823 | Actual Rate (Port R) | 0:Autodetect 1:10Mbps Full 2:10Mbps Half 3:100Mbps Full 4:100Mbps Half | 0 |
| <i>F792-F799</i> | 0792-0799 | DEVICE NAME (*1) | 16 characters by a hex digit 0h to FFFFh for each of fields. (There are 2 characters per one parameter.) The device name is required if the card uses DHCP to obtain its IP Address. | 0,0,0,0 0,0,0,0 (HEX) (*2) |
| <i>F576</i> | 0576 | IP mode (*1) | Use this parameter to select the IP address assignment method. 0:Manual 1:BOOTP 2:DHCP | 0 |
| <i>F577-F580</i> | 0577-0580 | IP address (*1) | IP address of the card 0 to 255 for each of fields. These fields are editable when IP mode = 0. | 0,0,0,0 |
| <i>F581-F584</i> | 0581-0584 | IP Mask (*1) | Subnet mask of the card 0 to 255 for each of fields. These fields are editable when IP mode = 0. | 0,0,0,0 |
| <i>F585-F588</i> | 0585-0588 | IP Gate (*1) | Gateway IP address of the card 0 to 255 for each of fields. These fields are editable when IP mode = 0. | 0,0,0,0 |
| <p>If the address has been given by a BOOTP or a DHCP server, these fields ("IP address", "IP Mask", "IP Gate") are read only.</p> <ul style="list-style-type: none"> •If you enter a value other than [0.0.0.0] (0) (0) (0) (0), dynamic addressing by a BOOTP or DHCP server is disabled. •After dynamic addressing by a BOOTP or DHCP server, the new address value is displayed. | | | | |
| <i>F589-F592</i> | 0589-0592 | IP Master | 0 to 255 for each of fields. • If the value is [0.0.0.0] then accepted by the Ethernet card regardless of which device has sent it. •If the value is other than [0.0.0.0] then only the device which has the IP address [IP Master] is authorized to write. | 0,0,0,0 |
| <i>F784-F789</i> | 0784-0789 | MAC address | MAC address display 0 to 255 for each of fields. | ---- |
| <i>F594</i> | 0594 | Time Out on Modbus Communication | 0: No Time-Out (unit:1=0.1s) 1 to 600 (0.1s to 60.0s) | 0 |

| Title | Communication No. | Function | Description | Factory setting |
|------------------|-------------------|---|--|-----------------|
| <i>F851</i> | 0851 | Operation at communication error by disconnection | 0: Inverter stop, communication command, frequency mode open (by <i>ENOD, FNOD</i>) 1: None (continued operation) 2: Deceleration stop 3: Coast stop 4: Network error (<i>ERRB</i> trip) 5: Preset speed operation (by <i>F852</i> setting) | 0 |
| <i>F852</i> | 0852 | Preset speed operation selection | 0:None 1~15:Preset speed operation (by parameter setting) | 0 |
| <i>F593</i> | 0593 | Enable IO Scanner | 0: IO Scanner disabled 1: IO Scanner Enabled | 0 |
| <i>F831-F838</i> | 0831-0838 | IO Scanner Command data | 0: No action 1: FA06 (Communication option command 1) 2: FA23 (Communication option command 2) 3: FA07 (Communication option frequency command, 0.01Hz) 4: FA33 (Torque command, 0.01%) 5: FA50 (Terminal output) 6: FA51 (Analog output (FM) data from comm.) 7: FA52 (Analog output (AM) data from comm.) 8: F601 (Stall prevention level, %) 9: F441 (Power running torque limit 1 level, 0.01%) 10: F443 (Regenerative braking torque limit 1 level, 0.01%) 11: F460 (Speed loop proportional gain) 12: F461 (Speed loop stabilization coefficient) | 0 |
| <i>F841-F848</i> | 0841-0848 | IO Scanner Monitor data | 0: No action 1: FD01 (Inverter status 1) 2: FD00 (Output frequency, 0.01Hz) 3: FD03 (Output current, 0.01%) 4: FD05 (Output voltage, 0.01%) 5: FC91 (Inverter alarm) 6: FD22 (PID feedback value, 0.01Hz) 7: FD06 (Input terminal status) 8: FD07 (Output terminal status) 9: FE36 (VI/II input) 10: FE35 (RR/S4 input) 11: FE37 (RX input) 12: FD04 (Input voltage (DC detection), 0.01%) 13: FD16 (Speed feedback (real-time value)) 14: FD18 (Torque, 0.01%) 15: FE60 (My monitor) 16: FE61 (My monitor) 17: FE62 (My monitor) 18: FE63 (My monitor) 19: F880 (Free notes) 20: FD29 (Input power, 0.01kW) 21: FD30 (Output power, 0.01kW) 22: FE14 (Cumulative operation time, 0.01=1 hour) 23: FE40 (FM terminal output monitor) 24: FE41 (AM terminal output monitor) | 0 |
| <i>F899</i> | 0899 | Network option reset setting | 0:None 1:Reset option circuit board and inverter | 0 |
| — | FE66 | Add-on option 1 CPU version (Under side option) | High byte is version. Low byte is revision. For example, When version number 1, and revision number 2 is, panel indication becomes with 1.02. The version of the option with it has equipped can be checked by using the function of <i>F710</i> to <i>F718</i> (standard monitor display selection). | — |
| — | FE67 | Add-on option 2 CPU version (Panel side) | *For details, refer to the inverter instruction manual. | — |

(*1): This parameter is effective by reset. Please reset (power supply reset or *F899=1*) after changing a set point.

(*2): The Factory default setting parameter (*EEP*) does not work for this parameter.

5. Command & Setpoint selection (Local/Remote)

Indication to display Local/Remote mode is on the inverter unit (Refer to the inverter instruction manual for details). ModbusTCP option command and setpoint are activated on Remote mode.

Inverters have some switches to select the command and setpoint location. Following figure shows the diagram. Refer to the inverter instruction manual for the parameter in detail.

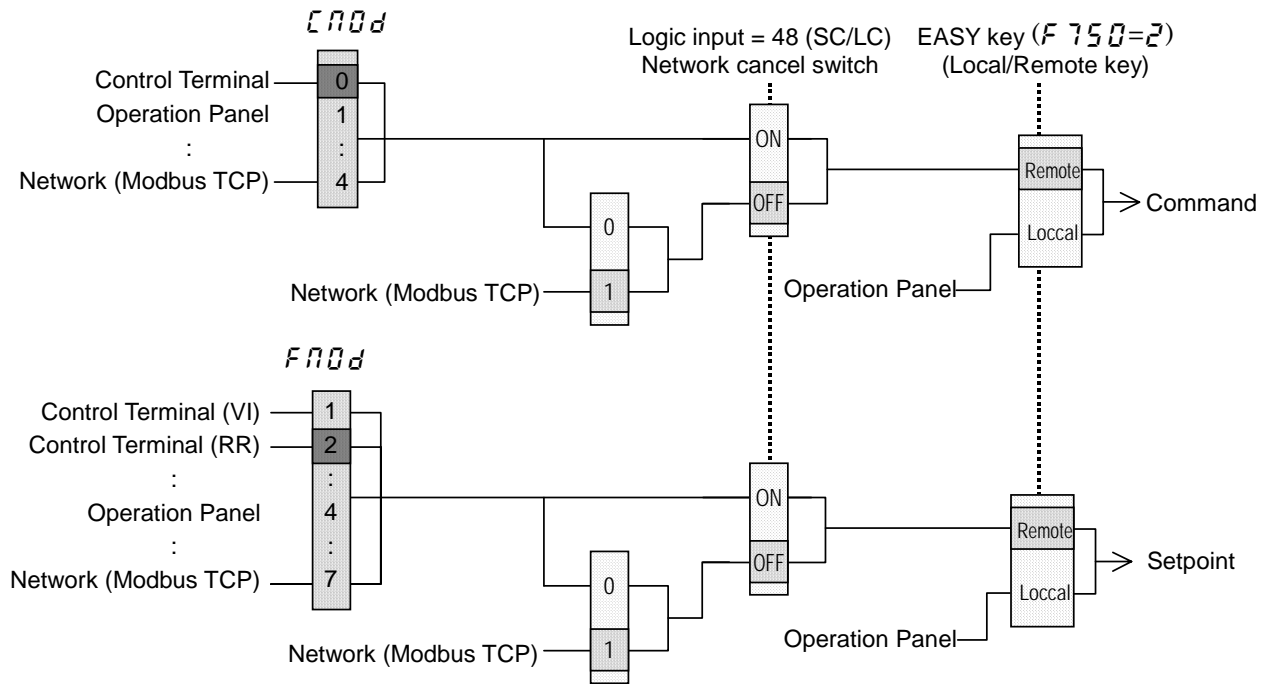

<Example>

The example below shows how to configure the VF-AS1/PS1 for local/remote operation.

- F terminal..... Operating command
- R terminal..... ModbusTCP local/remote (Terminal in this example) switching
- RR/S4 terminal..... Operation frequency command

<Wiring>

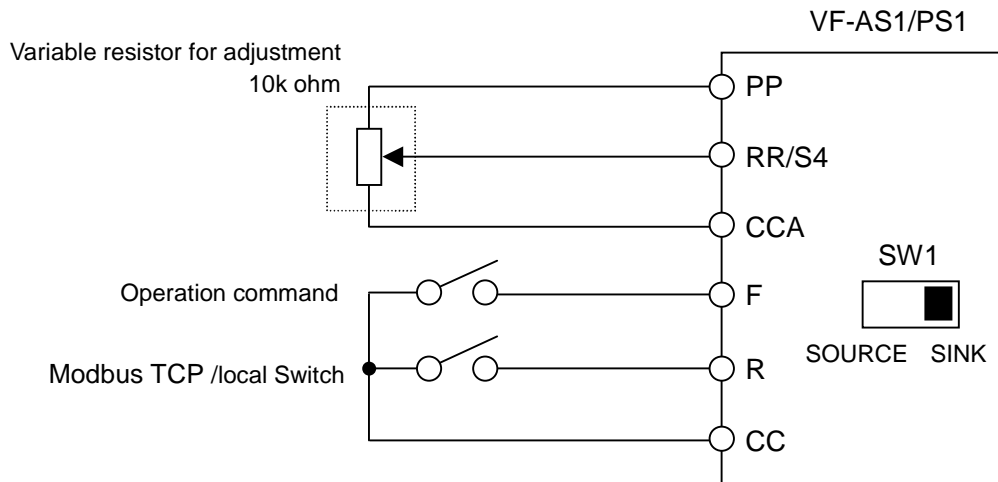

<Parameter setting>

- $F 7 5 0 = 0$ (Command mode selection) = 0 (Terminal board)
- $F 7 5 1 = 2$ (Frequency setting mode selection 1) = 2 (RR/S4)
- $F 1 1 2$ (Input terminal selection 2 (R)) = 48 (Remote/Local control)

<Operation>

R-CC terminal open: VF-AS1/PS1 is controlled as a slave device of The ModbusTCP.

R-CC terminal closed:

- F-CC terminal short to RUN
- F-CC terminal open to STOP
- Output frequency is set up by the RR/S4 signal input.

(Note)

When the local(HAND) / remote key ($F 7 5 0 = 2$) is chosen as EASY key selection and the EASY key lamp of an inverter front panel is on, priority is most given to operation by a panel. (Refer to the inverter instruction manual for details).

Note that the HAND mode of the panel has priority over FLN local control.

6. Specifications

| Item | Specification |
|---------------------|---|
| Model number | MBE001Z |
| Ethernet | Baud-rate: Auto negotiation or manual selection of data rate and duplex can be selected. 10Mbps Full/10Mbps Half/100Mbps Full/100Mbps Half |
| Service environment | Conforms to VF-AS1/PS1 |
| Ambient temperature | Conforms to VF-AS1/PS1 |
| Storage temperature | Conforms to VF-AS1/PS1 |
| Relative humidity | Conforms to VF-AS1/PS1 |
| Vibration | Conforms to VF-AS1/PS1 |
| Power supply | 24VDC supplied from the inverter |

7. Warranty

Any part ModbusTCP communication option that is proved to be defective will be repaired free of charge under the following conditions:

1. This product will be repaired free of charge, if problem/fault occurs under normal handling within one year of delivery and is caused obviously by a design or manufacturing defect.
2. The warranty applies only to the delivered product.
3. For the following kinds of failure or damage, the repair cost shall be borne by the customer even within the warranty period.
 - i) Failure or damage caused by improper or incorrect use or handling, or unauthorized repair or modification of the inverter.
 - ii) Failure or damage caused by the unit falling or an accident during transportation after the purchase.
 - iii) Failure or damage caused by fire, salty water or wind, corrosive gas, earthquake, storm or flood, lightning, abnormal voltage supply, or other natural disasters.
 - iv) Damage due to the use of ModbusTCP communication option for non-intended purposes.
4. If an additional warranty is provided then those conditions will also apply.