

TOSVERT VF-MB1/S15

DeviceNet Option Function Manual

DEV003Z-1

NOTICE

1. Read this manual before installing or operating. Keep this instruction manual on hand of the end user, and make use of this manual in maintenance and inspection.
2. All information contained in this manual will be changed without notice. Please contact your Toshiba distributor to confirm the latest information.

Contents

- 1. Introduction 2
- 2. Connection Information 6
 - 2.1. Connection Sizes 6
 - 2.2. Exterior overview 6
 - 2.3. DeviceNet LED indicator 7
 - 2.4. VF-MB1/S15 Communications-related parameters..... 8
- 3. Object Specifications 9
 - 3.1. Identity Object..... 10
 - 3.2. Message Router Object..... 12
 - 3.3. DeviceNet Object..... 13
 - 3.4. Assembly Object..... 14
 - 3.5. Connection Object 32
 - 3.6. Motor Data Object..... 36
 - 3.7. Control Supervisor Object 37
 - 3.8. AC/DC Drive Object..... 40
 - 3.9. Acknowledge Handler Object 42
 - 3.10. Parameter Object (Vender Specific Profiles)..... 43
- 4. DeviceNet Local/Remote Operation..... 44
- 5. EDS file..... 44

1. Introduction

Thank you for purchasing the DeviceNet option “DEV003Z” for the VF-MB1/S15. Before using the DeviceNet option, please familiarize yourself with the product and be sure to thoroughly read the instructions and precautions contained in this manual.

In addition, please make sure that this manual and “Installation Manual” is delivered to the end user, and keep this function manual in a safe place for future reference or drive/interface inspection.

This option needs the option adaptor to connect VF-S15 which type form is SBP009Z. Please match here and buy it when SBP009Z is not at hand yet.

This manual describes the supported functions for the “DEV003Z”.



In conjunction with this manual, the following manuals are supplied by Toshiba, and are essential both for ensuring a safe, reliable system installation as well as for realizing the full potential of the “DEV003Z”:

- TOSVERT VF-MB1 Instruction ManualE6581697
- TOSVERT VF-S15 Instruction ManualE6581611
- VF-MB1/S15 communication option Precautions ManualE6581739

Safety precautions

On the inverter and in its instruction manual, important information is contained for preventing injuries to users and damages to assets and for proper use of the device. Read the instruction manual attached to VF-MB1/S15 along with this instruction manual for completely understanding the safety precautions and adhere to the contents of these manuals.



Explanation of markings

Marking	Meaning of marking
 Warning	Indicates that errors in operation may lead to death or serious injury.
 Caution	Indicates that errors in operation may lead to injury (*1) to people or that these errors may cause damage to physical property. (*2)



(*1) Such things as injury, burns or shock that will not require hospitalization or long periods of outpatient treatment.

(*2) Physical property damage refers to wide-ranging damage to assets and materials.



Meanings of symbols

Marking	Meaning of marking
	Indicates prohibition (Don't do it). What is prohibited will be described in or near the symbol in either text or picture form.
	Indicates something mandatory (must be done). What is mandatory will be described in or near the symbol in either text or picture form.
	Indicates warning. What is warned will be described in or near the symbol in either text or picture form. Indicates caution. What the caution should be applied to will be described in or near the symbol in either text or picture form.

■ General Operation

⚠ Warning	
 Disassembly prohibited	▼ Never disassemble, modify or repair. Doing so could result in electric shock, fire and injury. For repairs, call your sales agency.
 Prohibited	▼ Do not attach this option to any inverter other than the VF-MB1/S15. Doing so could result in electric shock or fire. ▼ When the inverter is energized, never detach the this option from the VF-MB1/S15. Doing so could result in electric shock. ▼ Don't place or insert any kind of object into the DEV003Z (electrical wire cuttings, rods, wires). Doing so could result in electric shock or fire. ▼ Do not allow water or any other fluid to come in contact with the DEV003Z. Doing so could result in electric shock or fire.
 Mandatory	▼ Turn off the VF-MB1/S15 when installing and wiring this option. ▼ If the inverter begins to emit smoke or an unusual odor, or unusual sounds, immediately turn power off. If the equipment is continued in operation in such a state, the result may be fire. Call your local sales agency for repairs.



■ Transportation & installation

⚠ Warning	
 Prohibited	▼ Do not operate the inverter if it is damaged or any component is missing. Doing so could result in electric shock or fire. Call your local sales agency for repairs. ▼ Do not place any inflammable substances near the VF-MB1/S15 Inverter. If an accident occurs in which flame is emitted, this could lead to fire. ▼ Do not install in any location where the inverter could come into contact with water or other fluids. Doing so could result in electric shock or fire.
 Mandatory	▼ Operate under the environmental conditions prescribed in the instruction manual. Operations under any other conditions may result in malfunction.



■ Wiring

⚠ Warning	
 Mandatory	▼ Shut off power when installing and wiring this option. Wait at least 15 minutes and check to make sure that the charge lamp (VF-MB1/S15) is no longer lit. ▼ Electrical construction work must be done by a qualified expert. Installation or connection of input power by someone who does not have that expert knowledge may result in fire or electric shock.

■ Operations

 Warning	
 Prohibited	<ul style="list-style-type: none"> ▼ Do not touch switches when the hands are wet and do not try to clean the inverter with a damp cloth. Doing so could result in electric shock. ▼ Do not pull on any cable itself. Doing so could result in damage or malfunction.
 Mandatory	<ul style="list-style-type: none"> ▼ Check DeviceNet state (using below attribute) when the option unit is deactivated by an unusual event such as an operating error, power outage, failure, etc. <ul style="list-style-type: none"> - Identity Object Instance Attributes 8 (State) (The communication error occurs when Fault (4, 5) or this value cannot be read.) Deactivated option unit may cause an accident, if the DeviceNet state is not checked. ▼ Make sure that the operation signals are STOP before clearing the inverter's fault. The motor may suddenly start and that may result in injuries.

■ Disposal

 Caution	
 Mandatory	<ul style="list-style-type: none"> ▼ For safety's sake, do not dispose of the disused inverter yourself but ask an industrial waste disposal agent (*). If the collection, transport and disposal of industrial waste is done by someone who is not licensed for that job, it is a punishable violation of the law. (Laws in regard to cleaning and processing of waste materials) (*) Persons who specialize in the processing of waste and known as "industrial waste product collectors and transporters" or "industrial waste disposal persons."

Notes on use

Notes	
	<ul style="list-style-type: none"> ▼ Do not install the inverter where the temperature or the humidity will change rapidly. ▼ Keep a distance of 20cm or more between the inverter's power cable and the data transmission cable. Or the inverter might malfunction because of noise. ▼ Insert a magnetic contactor or similar device between the inverter and the power supply to ensure that power is turned off if an emergency stop command is entered through the network. ▼ When the control power is shut off by the instantaneous power failure, communication will be unavailable for a while. ▼ The Life of EEPROM is approximately 100,000 times. Avoid writing a command more than 100,000 times to the same parameter of the Inverter and the communication board.

2. Connection Information

2.1. Connection Sizes

Connection Instance	Produced	Consumed
I/O Messaging	4, 8, 12 or 18 bytes	4, 8, 12 or 18 bytes
Explicit Messaging	39 bytes	39 bytes

- For the Polled I/O connection, if the actual consumed data size is bigger than the connection instance's consumed_connection_size attribute, the consumed data will be ignored, but the connection will otherwise produce normally. If the actual consumed data size is larger than the connection instance's consumed_connection_size attribute, the consumed data will be ignored and the connection will not produce.
- For the Explicit Messaging connection, this is the maximum message length: shorter messages are also acceptable.

2.2. Exterior overview

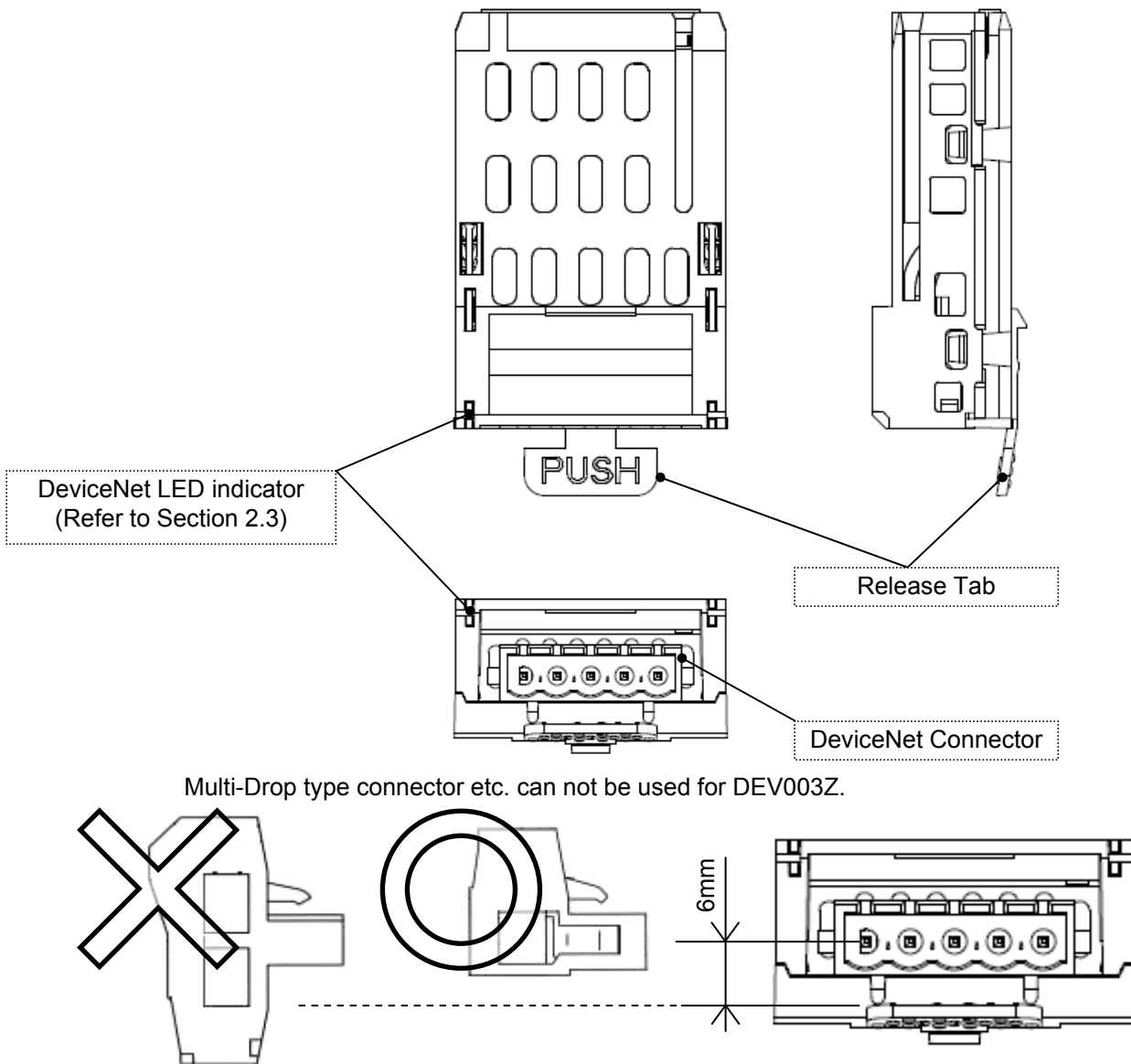

2.3. DeviceNet LED indicator

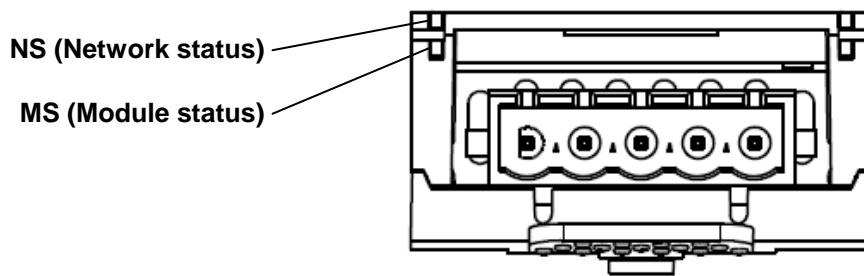

NS (Network status)

This bi-color (green/red) LED indicates the status of the communication link from the DEV003Z to DeviceNet. (According to ODVA DeviceNet Specifications.)

LED is:	For this state:	To indicate:
Off	Not Powered/Not On-line	Device is not on-line. - The device has not completed the Dup_MAC_ID test yet. - The device may not be powered, look at Module Status LED.
Green	On-line and connect	The device is on-line and has connections in the established state. - The device is allocated to a Master.
Flashing Green	On-line, not connect	Device is connected to the network but has no connections in the established state. - The device is not allocated to a master.
Flashing Red	Connection Time-out	Recoverable Fault. One or more I/O Connections are in the Timed-Out state.
Red	Critical Link Failure	Non Recoverable fault. The device has detected an error that has rendered it incapable of communicating on the network (Duplicate MAC ID, or Bus-off). Check parameters [2 0 0] then Cycle power to VF-MB1 to reset this fault.
Flashing Red-Green	Communication Faulted and Received an Identify Comm Fault Request - Long Protocol	A specific Communication Faulted device. The device has detected a Network Access error and is in the Communication Faulted state. The device has subsequently received and accepted an Identify Communication Faulted Request - Long Protocol message

MS (Module status)

This bi-color (green/red) LED indicates the status of the communication link from DEV003Z to the VF-MB1/S15. It indicates whether or not the device has power and is operating properly.

(According to ODVA DeviceNet Specifications.)

LED is:	For this state:	To indicate:
Off	Power OFF	There is no power applied to the device.
Green	Device Operational	The device is operating in a normal condition.
Flashing Green	Device in Standby	The device needs commissioning due to configuration missing, incomplete or incorrect. The Device may be in the Standby state.
Flashing Red	Minor Fault	Recoverable Fault.
Red	Unrecoverable Fault	The device has an unrecoverable fault; may need replacing.
Flashing Red-Green	Device Self Testing	The Device is in Self Test.

2.4. VF-MB1/S15 Communications-related parameters

In a network, VF-MB1/S15 (DEV003Z) serves as a DeviceNet slave device. DEV003Z configuration is set by the following parameters.

Parameter	Function	Adjustment range	Default setting
$\mathcal{C}200$	DEV003Z MAC ID	0 to 63	63
$\mathcal{C}201$	DEV003Z Communication baud rate	DEV003Z communication baud rate is set. 0: AUTO * 1: 125kbps 2: 250kbps 3: 500kbps	0
$\mathcal{C}202$	DeviceNet Baud rate monitor	DeviceNet communication baud rate is shown. 1: 125kbps 2: 250kbps 3: 500kbps	-
$\mathcal{C}203$	DEV003Z Assembly Object	0: Instance 20/70 1: Instance 21/71 2: Instance 100/150 3: Instance 101/151 4: Instance 102/152 5: Instance 105/155	0
$\mathcal{C}100$	Communication error detection delay time	0.0 to 100.0s	0.0
$\mathcal{C}101$	Inverter operation at the communications loss action (Network wire breaks)	0: Stop and Communication release ** (follows $\mathcal{C}n0d$ and $Fn0d$ setting) 1: None 2: Deceleration stop 3: Coast stop 4: Emergency stop ($ErrB$) *** 5: Preset speed operation command (Operating at the preset speed operation frequency set with $\mathcal{C}102$)	4
$\mathcal{C}102$	Preset speed operation selection	0: None 1 to 15: Preset speed ($Sr1-Sr7, F287-F295$)	0
$\mathcal{C}103$	Communication time-out condition selection	0: Disconnection detection 1: When communication mode enable (Both $\mathcal{C}n0d$ and $Fn0d$ are set CANopen or COM option) 2: 1+Driving operation	0
$F899$	Network option reset setting	0: None 1: Resetting the DEV003Z and the inverter	0
$Fd67$	DEV003Z version	DEV003Z firmware version (ex. 0x1101 means "V1.01")	-

* DeviceNet baud rate is 500kbps and with a few slaves in the network, auto baud rate function might not work.

** Do not set at VF-MB1 V1.00.

*** When the parameter is changed, the power must be cycled (or set $F899$ to 1) to the VF-MB1/S15 for the changes to take effect. 1 to $F899$ by the DeviceNet communication might not be able to be set.



Caution

Please note that inverter keeps driving when the communication is lost if 1 (None) is set to the parameter $\mathcal{C}101$ (Inverter operation at the communications loss action).

3. Object Specifications

This section contains the object specifications for all DeviceNet objects currently supported by the “DEV003Z”. Table 1 outlines those objects covered:

Class Code	Object Class	Page
0x01	Identity Object	10
0x02	Message Router Object	12
0x03	DeviceNet Object	13
0x04	Assembly Object	14
0x05	Connection Object	33
0x28	Motor Data Object	37
0x29	Control Supervisor Object	38
0x2A	AC/DC Drive Object	41
0x2B	Acknowledge Handler Object	42
0x65 (0x64)	Parameter Object (Vender Specific Profiles)	43

Table 1: Supported Objects

For definitions of all data types referred to in these object specifications, refer to the ODVA DeviceNet Specifications. In general, however, the following are some of the most prevalent types:

- SINT Signed 8-bit integer value
- USINT Unsigned 8-bit integer value
- BYTE Bit string - 8-bits
- INT Signed 16-bit integer value
- UINT Unsigned 16-bit integer value
- WORD Bit string - 16-bits
- UDINT Unsigned 32-bit integer value

3.1. Identity Object

Class code 0x01. This object provides identification of and general information about the device.

3.1.1. Identity Object Class Attributes

Attribute ID	Name	Data Type	Access Rules	Description	Default Value
1	Revision	UINT	Get	Revision of this object	1
2	Max instance	UINT	Get	Maximum instance number of an object currently created in this class level of the device	1

3.1.2. Identity Object Instance Attributes

Attribute ID	Name	Data Type	Access Rules	Description	Default Value
1	Vendor ID	UINT	Get	Identification of vendor by number	377
2	Device type	UINT	Get	Indication of general type of product	2 (AC Drive)
3	Product code	UINT	Get	Identification of a particular product of an individual vendor	VF-MB1:3000 VF-S15 :3001
4	Revision * (Major)	USINT (ARRAY)	Get	Revision of the item the Identity Object represents	(01)
	Revision * (Minor)	USINT (ARRAY)	Get		(01)
5	Status (bits supported) **	WORD	Get	Summary status of device	-
6	Serial number	UDINT	Get	Serial number of device	-
7	Product name	SHORT_STRING	Get	Human-readable identification	"DEV003Z"
8	State	USINT	Get	Present state of the device 0 = Non-existent 1 = Device Self Testing 2 = Standby 3 = Operational 4 = Major Recoverable Fault 5 = Major Unrecoverable Fault	-
10	Heartbeat Interval	USINT	Get/Set	The nominal interval between heartbeat messages in seconds.	0

* DEV003Z software version.

ex.) If Major = 0x01 and Minor = 0x01, DEV003Z Version is "101".

** Attribute 5 Status:

Bit	Note
0	Owned by Master (predefined Master/Slave Connection)
2	Configured.
4-7	Extended device status 0000 = Unknown 0010 = Faulted I/O connection 0011 = No I/O connection established 0100 = Non volatile configuration bad 0101 = Major fault 0110 = Connection in run mode 0111 = Connection in idle mode
8	Minor Recoverable Fault
9	Minor Unrecoverable Fault.
10	Major Recoverable Fault.
11	Major Unrecoverable Fault
etc.	0 (Reserved)

3.1.3. Identity Object Common Services

Service Code	Service Name	Supported		Description of Service
		Class	Instance	
0x05	Reset	N/A	Yes	Invokes the Reset service for the device
0x0E	Get_Attribute_Single	Yes	Yes	Returns the contents of the specified attribute.
0x10	Set_Attribute_Single	N/A	Yes	Modifies the value of the specified attribute.

3.1.4. Identity Object Specific Services

Identity Object provides no object specific services.

3.2. Message Router Object

Class Code 0x02. The Message Router Object provides a messaging connection point through which a Client may address a service to any object class or instance residing in the physical device.

3.2.1. Message Router Object Class Attributes

Attribute ID	Name	Data Type	Access Rules	Description	Default Value
1	Revision	UINT	Get	Revision of this object	1
2	Max instance	UINT	Get	Maximum instance number of an object currently created in this class level of the device	1

3.2.2. Message Router Object Instance Attributes

Attribute ID	Name	Data Type	Access Rules	Description	Default Value
1	Object list	STRUCT	Get	A list of supported objects	-
	Number	UINT	Get	Number of supported classes in the classes array	11
	Classes	UINT (ARRAY)	Get	List of supported class codes	-
2	Number available	UINT	Get	Maximum number of connections supported	16
3	Number active	UINT	Get	Number of connections currently used by system components	-
4	Activec connections	UINT (ARRAY)	Get	A list of the connection IDs of the currently active connections	-

3.2.3. Message Router Object Common Services

Service Code	Service Name	Supported		Description of Service
		Class	Instance	
0x0E	Get_Attribute_Single	Yes	Yes	Returns the contents of the specified attribute.

3.2.4. Message Router Object Specific Services

Message Router Object provides no object specific services.

3.3. DeviceNet Object

Class Code 0x03. The DeviceNet Object provides for the configuration and status of a DeviceNet port.

3.3.1. DeviceNet Object Class Attributes

Attribute ID	Name	Data Type	Access Rules	Description	Default Value
1	Revision	UINT	Get	Revision of this object.	2
2	Max instance	UINT	Get	Maximum instance number of an object currently created in this class level of the device	1

3.3.2. DeviceNet Object Instance Attributes

Attribute ID	Name	Data Type	Access Rules	Description	Default Value
1	MAC ID	USINT	Get	Node address	63
2	Baud Rate	USINT	Get	Baud rate 0 = 125kbps 1 = 250kbps 2 = 500kbs	-
3	Bus-off Interrupt	BOOL	Get/Set	Bus-Off Interrupt	0
4	Bus-off counter	USINT	Get/Set	Number of times CAN went to the bus-off state	0
5	Allocation information (Allocation Choice Byte)	BYTE	Get	Master/Slave allocation state *	-
	Allocation information (Master's MAC ID)	USINT	Get	MAC ID of Master (from Allocate)	-

3.3.3. DeviceNet Object Common Services

Service Code	Service Name	Supported		Description of Service
		Class	Instance	
0x0E	Get_Attribute_Single	Yes	Yes	Returns the contents of the specified attribute.
0x10	Set_Attribute_Single	N/A	Yes	Modifies the value of the specified attribute.

3.3.4. DeviceNet Object Specific Services

DeviceNet Object provides no object specific services for the slave.

* Attribute 5 Allocation Choice Byte

Bit	Note
0	Explicit
1	Poll
2	Bit Strobe
3	Multicast Poll
4	Change of State
5	Cyclic
6	ACK Suppression
7	(Reserved)

3.4. Assembly Object

Class code 0x04. The Assembly Object binds attributes of multiple objects, which allows data to or from each object to be sent or received over a single connection.

3.4.1. Assembly Object Class Attributes

Attribute ID	Name	Data Type	Access Rules	Description	Default Value
1	Revision	UINT	Get	Revision of this object.	2
2	Max instance	UINT	Get	Maximum instance number of an object currently created in this class level of the device	155

3.4.2. Assembly Object Instance Attributes

Attribute ID	Name	Data Type	Access Rules	Description	Default Value
3	Data	BYTE (ARRAY)	Get/Set	The data contained in the assembly object. (Refer to section 3.4.5.)	-

3.4.3. Assembly Object Common Services

Service Code	Service Name	Supported		Description of Service
		Class	Instance	
0x0E	Get_Attribute_Single	Yes	Yes	Returns the contents of the specified attribute.
0x10	Set_Attribute_Single	N/A	Yes	Modifies the value of the specified attribute.

3.4.4. Assembly Object Specific Services

Assembly Object for static assemblies provides no object specific services.

3.4.5. Assembly Instance Details

3.4.5.1. Instance 20/70 - DeviceNet Standard (4 bytes, parameter [203] = 0)

Byte	Bit 7	Bit 6	Bit 5	Bit 4	Bit 3	Bit 2	Bit 1	Bit 0
0	-	-	-	-	-	Fault reset	-	Run forward
1	-							
2	Drive Reference Speed min ⁻¹ (Low byte) *							
3	Drive Reference Speed min ⁻¹ (High byte) *							

Fig. 1 Output Instance 20 Layout

Byte	Bit 7	Bit 6	Bit 5	Bit 4	Bit 3	Bit 2	Bit 1	Bit 0
0	-	-	-	-	-	Running Forward	-	Faulted/tripped
1	-							
2	Drive Actual Speed min ⁻¹ (Low byte)							
3	Drive Actual Speed min ⁻¹ (High byte)							

Fig. 2 Input Instance 70 Layout

* When Instance 20/70 is used, set [704] and [705] to "Communication option".

Examples of Instance 20/70

① Stop

Instance	Byte	15	14	13	12	11	10	9	8	7	6	5	4	3	2	1	0	Hex.
Output Instance 20	1, 0	0	0	0	0	0	0	0	0	0	0	0	0	0	0	0	0	0x0000
	3, 2	-	-	-	-	-	-	-	-	-	-	-	-	-	-	-	-	-
Input Instance 70	1, 0	0	0	0	0	0	0	0	0	0	0	0	0	0	0	0	0	0x0000
	3, 2	0	0	0	0	0	0	0	0	0	0	0	0	0	0	0	0	0x0000

② Forward running 1800min-1

Instance	Byte	15	14	13	12	11	10	9	8	7	6	5	4	3	2	1	0	Hex.
Output Instance 20	1, 0	0	0	0	0	0	0	0	0	0	0	0	0	0	0	0	1	0x0001
	3, 2	0	0	0	0	0	1	1	1	0	0	0	0	1	0	0	0	0x0708
Input Instance 70	1, 0	0	0	0	0	0	0	0	0	0	0	0	0	0	1	0	0	0x0004
	3, 2	0	0	0	0	0	1	1	1	0	0	0	0	1	0	0	0	0x0708

③ Fault reset **

Instance	Byte	15	14	13	12	11	10	9	8	7	6	5	4	3	2	1	0	Hex.
Output Instance 20	1, 0	0	0	0	0	0	0	0	0	0	0	0	0	0	1	0	0	0x0004
	3, 2	-	-	-	-	-	-	-	-	-	-	-	-	-	-	-	-	-

* Drive Reference Speed is set up number of rotations by the hexadecimal number.
 For example, when "Frequency reference" is set up to 1800min⁻¹:
 1800 = 0x0708 (Hex.)

** Fault reset works only 1 time when 0 -> 1.

3.4.5.2. Instance 21/71 - DeviceNet Standard (4 bytes, parameter $\lfloor 20 \rfloor = 1$)

Byte	Bit 7	Bit 6	Bit 5	Bit 4	Bit 3	Bit 2	Bit 1	Bit 0
0	-	Net Ref *	Net Ctrl *	-	-	Fault reset	Run reverse	Run forward
1	-							
2	Drive Reference Speed min^{-1} (Low byte)							
3	Drive Reference Speed min^{-1} (High byte)							

Fig. 3 Output Instance 21 Layout

Byte	Bit 7	Bit 6	Bit 5	Bit 4	Bit 3	Bit 2	Bit 1	Bit 0
0	At reference **	Ref from Net **	Ctrl from Net **	Ready	Running Reverse	Running Forward	Warning	Faulted/tripped
1	Drive Status ***							
2	Drive Actual Speed min^{-1} (Low byte)							
3	Drive Actual Speed min^{-1} (High byte)							

Fig. 4 Input Instance 71 Layout

* Bit 5 and 6 of the instance 21 byte 0 are defined as follows.

Bit 5 (Net Ctrl)..... When “1” is set, bits 0 (Run forward) and 1 (Run reverse) of byte 0 are enabled. When “0” is set, Run/Stop is according to setup of the VF-MB1/S15 parameter $\lfloor n0d \rfloor$.

Bit 6 (Net Ref)..... When “1” is set, Drive Reference Speed is according to the value of bytes 2 and 3. When “0” is set, Drive Reference Speed is according to setup of the VF-MB1/S15 parameter $\lfloor n0d \rfloor$.

** Bit 5, 6, and 7 of the instance 71 byte 0 are defined as follows.

Bit 5 (Ctrl from Net)..... When RUN/STOP command from DeviceNet is enabled, “1” is set.

Bit 6 (Ref from Net)..... When frequency command from DeviceNet is enabled, “1” is set.

Bit 7 (At reference) When output frequency becomes the same as frequency command, “1” is set.

*** Drive Status is same as the Control Supervisor class State attribute (refer to section 3.7.2).

- 1 (00000001): Startup
- 2 (00000010): Not Ready
- 3 (00000011): Ready
- 4 (00000100): Enabled
- 5 (00000101): Stopping
- 6 (00000110): Fault Stop
- 7 (00000111): Faulted

Examples of Instance 21/71

① Stop

Instance	Byte	15	14	13	12	11	10	9	8	7	6	5	4	3	2	1	0	Hex.
Output Instance 21	1, 0	0	0	0	0	0	0	0	0	0	0	0	0	0	0	0	0	0x0000
	3, 2	-	-	-	-	-	-	-	-	-	-	-	-	-	-	-	-	-
Input Instance 71	1, 0	0	0	0	0	0	0	1	1	0	0	0	1	0	0	0	0	0x0310
	3, 2	0	0	0	0	0	0	0	0	0	0	0	0	0	0	0	0	0x0000

② Forward running 1800min⁻¹

Instance	Byte	15	14	13	12	11	10	9	8	7	6	5	4	3	2	1	0	Hex.
Output Instance 21	1, 0	0	0	0	0	0	0	0	0	0	1	1	0	0	0	0	1	0x0061
	3, 2	0	0	0	0	0	1	1	1	0	0	0	0	1	0	0	0	0x0708
Input Instance 71	1, 0	0	0	0	0	0	1	0	0	1	1	1	1	0	1	0	0	0x04F4
	3, 2	0	0	0	0	0	1	1	1	0	0	0	0	1	0	0	0	0x0708

③ Reverse running 1800min⁻¹

Instance	Byte	15	14	13	12	11	10	9	8	7	6	5	4	3	2	1	0	Hex.
Output Instance 21	1, 0	0	0	0	0	0	0	0	0	0	1	1	0	0	0	1	0	0x0062
	3, 2	0	0	0	0	0	1	1	1	0	0	0	0	1	0	0	0	0x0708
Input Instance 71	1, 0	0	0	0	0	0	1	0	0	1	1	1	1	1	0	0	0	0x04F8
	3, 2	0	0	0	0	0	1	1	1	0	0	0	0	1	0	0	0	0x0708

④ Fault reset *

Instance	Byte	15	14	13	12	11	10	9	8	7	6	5	4	3	2	1	0	Hex.
Output Instance 21	1, 0	0	0	0	0	0	0	0	0	0	0	0	0	0	1	0	0	0x0004
	3, 2	-	-	-	-	-	-	-	-	-	-	-	-	-	-	-	-	-

* Fault reset works only 1 time when 0 -> 1.

3.4.5.3. Instance 100/150 - Toshiba Specific (4 bytes, parameter $\lfloor 203 \rfloor = 2$)

Byte	Bit 7	Bit 6	Bit 5	Bit 4	Bit 3	Bit 2	Bit 1	Bit 0
0	DC braking	ACC1/ ACC2	PI off	THR2	Preset Speed4	Preset Speed3	Preset Speed2	Preset Speed1
1	Command link *	Frequency link *	Reset trip	Emergency stop	Free run (ST)	Run/stop	Forward/ Reverse	Jog
2	Drive Reference Speed Hz (Low byte) **							
3	Drive Reference Speed Hz (High byte) **							

Fig. 5 Output Instance 100 Layout

Byte	Bit 7	Bit 6	Bit 5	Bit 4	Bit 3	Bit 2	Bit 1	Bit 0
0	DC braking	ACC2	PI	THR 2 (VF2+tH2)	-	ALARM (fc91)	EMG	FL
1	-	READY without ST/RUN	READY with ST/ RUN	Emergency stop	Free run (ST)	Run/Stop	Forward / Reverse	Jog
2	Drive Actual Speed Hz (Low byte)							
3	Drive Actual Speed Hz (High byte)							

Fig. 6 Input Instance 150 Layout

* Bit 7 and 6 of the instance 100 byte 1 are defined as follows.

Bit 7 (Command link)..... When "0" is set, the other command does not work except bit 4 and 3 of instance 100 byte 1, Run/Stop is according to setup of the VF-MB1/S15 parameter $\lfloor n0d \rfloor$.

Bit 6 (Frequency link)..... When "1" is set, Drive Reference Speed is according to the value of bytes 2 and 3. When "0" is set, Drive Reference Speed is according to setup of the VF-MB1/S15 parameter $F n0d$.

** Drive Reference Speed is set up by 0.01Hz unit and the hexadecimal number.

For example, when "Frequency reference" is set up to 60Hz, since the minimum unit is 0.01Hz, $60 / 0.01 = 6000 = 0x1770$ (Hex.)

Examples of Instance 100/150

① Stop

Instance	Byte	15	14	13	12	11	10	9	8	7	6	5	4	3	2	1	0	Hex.
Output Instance 100	1, 0	0	0	0	0	0	0	0	0	0	0	0	0	0	0	0	0	0x0000
	3, 2	-	-	-	-	-	-	-	-	-	-	-	-	-	-	-	-	-
Input Instance 150	1, 0	0	1	0	0	1	0	0	0	0	0	0	0	0	0	0	0	0x4800
	3, 2	0	0	0	0	0	0	0	0	0	0	0	0	0	0	0	0	0x0000

② Forward running 60Hz

Instance	Byte	15	14	13	12	11	10	9	8	7	6	5	4	3	2	1	0	Hex.
Output Instance 100	1, 0	1	1	0	0	0	1	0	0	0	0	0	0	0	0	0	0	0xC400
	3, 2	0	0	0	1	0	1	1	1	0	1	1	1	0	0	0	0	0x1770
Input Instance 150	1, 0	0	1	1	0	0	1	0	0	0	0	0	0	0	0	0	0	0x6400
	3, 2	0	0	0	1	0	1	1	1	0	1	1	1	0	0	0	0	0x1770

③ Reverse running 60Hz

Instance	Byte	15	14	13	12	11	10	9	8	7	6	5	4	3	2	1	0	Hex.
Output Instance 100	1, 0	1	1	0	0	0	1	1	0	0	0	0	0	0	0	0	0	0xC600
	3, 2	0	0	0	1	0	1	1	1	0	1	1	1	0	0	0	0	0x1770
Input Instance 150	1, 0	0	1	1	0	0	1	1	0	0	0	0	0	0	0	0	0	0x6600
	3, 2	0	0	0	1	0	1	1	1	0	1	1	1	0	0	0	0	0x1770

④ Preset speed 1 with forward running ($\zeta_r i$)

Instance	Byte	15	14	13	12	11	10	9	8	7	6	5	4	3	2	1	0	Hex.
Output Instance 100	1, 0	1	0	0	0	0	1	0	0	0	0	0	0	0	0	0	1	0x8401
	3, 2	-	-	-	-	-	-	-	-	-	-	-	-	-	-	-	-	-
Input Instance 150 ($\zeta_r i$ is 5Hz.)	1, 0	0	1	1	0	0	1	0	0	0	0	0	0	0	0	0	0	0x6400
	3, 2	0	0	0	0	0	0	0	1	1	1	1	1	0	1	0	0	0x01F4

⑤ Fault reset *

Instance	Byte	15	14	13	12	11	10	9	8	7	6	5	4	3	2	1	0	Hex.
Output Instance 100	1, 0	0	0	1	0	0	0	0	0	0	0	0	0	0	0	0	0	0x2000
	3, 2	-	-	-	-	-	-	-	-	-	-	-	-	-	-	-	-	-

About the other command, refer to section エラー! 参照元が見つかりません。 .

* Fault reset works only 1 time when 0 -> 1.

3.4.5.4. Instance 101/151 - Toshiba Specific (8 bytes, parameter $\lfloor 20 \rfloor = 3$)

Byte	Bit 7	Bit 6	Bit 5	Bit 4	Bit 3	Bit 2	Bit 1	Bit 0
0	-	Net Ref *	Net Ctrl *	-	-	Fault reset	Run reverse	Run forward
1	-							
2	Drive Reference Speed min^{-1} (Low byte)							
3	Drive Reference Speed min^{-1} (High byte)							
4	Index (Low byte)							
5	Write	Index (High byte)						
6	Data (Low byte)							
7	Data (High byte)							

Fig. 7 Output Instance 101 Layout

Byte	Bit 7	Bit 6	Bit 5	Bit 4	Bit 3	Bit 2	Bit 1	Bit 0
0	At reference **	Ref from Net **	Ctrl from Net **	Ready	Running Reverse	Running Forward	Warning	Faulted/tripped
1	Drive Status ***							
2	Drive Actual Speed min^{-1} (Low byte)							
3	Drive Actual Speed min^{-1} (High byte)							
4	Index (Low byte)							
5	Write	Error	Index (High byte)					
6	Data (Low byte)							
7	Data (High byte)							

Fig. 8 Input Instance 151 Layout

* Bit 5 and 6 of the instance 101 byte 0 are defined as follows.

Bit 5 (Net Ctrl) When “1” is set, bits 0 (Run forward) and 1 (Run reverse) of byte 0 are enabled. When “0” is set, Run/Stop is according to setup of the VF-MB1/S15 parameter $\lfloor n0 \rfloor$.

Bit 6 (Net Ref) When “1” is set, Drive Reference Speed is according to the value of bytes 2 and 3. When “0” is set, Drive Reference Speed is according to setup of the VF-MB1/S15 parameter $F n0 d$.

** Bit 5, 6, and 7 of the instance151 byte 0 are defined as follows.

Bit 5 (Ctrl from Net)..... When RUN/STOP command from DeviceNet is enabled, “1” is set.

Bit 6 (Ref from Net)..... When frequency command from DeviceNet is enabled, “1” is set.

Bit 7 (At reference) When output frequency becomes the same as frequency command, “1” is set.

*** Drive Status is same as the Control Supervisor class State attribute (refer to 3.7.2).

- 1 (00000001): Startup
- 2 (00000010): Not Ready
- 3 (00000011): Ready
- 4 (00000100): Enabled
- 5 (00000101): Stopping
- 6 (00000110): Fault Stop
- 7 (00000111): Faulted

Examples of Instance 101/151

Access the inverter parameter is enabled using byte 4 to 7 of this Instance.

Set the communication number of the parameter to byte 4, 5 (Index), and the value to byte 6, 7 (Data).

① Read the parameter $\underline{C} \underline{0} \underline{0} \underline{3}$ (Command mode selection, communication number is 0003).

Instance	Byte	15	14	13	12	11	10	9	8	7	6	5	4	3	2	1	0	Hex.
Output Instance 101	5, 4	0	0	0	0	0	0	0	0	0	0	0	0	0	0	1	1	0x0003
	7, 6	-	-	-	-	-	-	-	-	-	-	-	-	-	-	-	-	-
Input Instance 151 ($\underline{C} \underline{0} \underline{0} \underline{3}$ is 0.)	5, 4	0	0	0	0	0	0	0	0	0	0	0	0	0	0	1	1	0x0003
	7, 6	0	0	0	0	0	0	0	0	0	0	0	0	0	0	0	0	0x0000

② Read the parameter $\underline{F} \underline{2} \underline{6} \underline{8}$ (Initial value of UP/DOWN frequency).

Instance	Byte	15	14	13	12	11	10	9	8	7	6	5	4	3	2	1	0	Hex.
Output Instance 101	5, 4	0	0	0	0	0	0	1	0	0	1	1	0	1	0	0	0	0x0268
	7, 6	-	-	-	-	-	-	-	-	-	-	-	-	-	-	-	-	-
Input Instance 151 ($\underline{F} \underline{2} \underline{6} \underline{8}$ is 60.0Hz.)	5, 4	0	0	0	0	0	0	1	0	0	1	1	0	1	0	0	0	0x0268
	7, 6	0	0	0	1	0	1	1	1	0	1	1	1	0	0	0	0	0x1770

③ Write “60 (Hz)” to the parameter $\underline{5} \underline{r} \underline{1}$ (Preset speed 1, communication number is 0018).

Instance	Byte	15	14	13	12	11	10	9	8	7	6	5	4	3	2	1	0	Hex.
Output Instance 101	5, 4	1	0	0	0	0	0	0	0	0	0	0	1	1	0	0	0	0x8018
	7, 6	0	0	0	1	0	1	1	1	0	1	1	1	0	0	0	0	0x1770
Input Instance 151 (OK)	5, 4	1	0	0	0	0	0	0	0	0	0	0	1	1	0	0	0	0x8018
	7, 6	0	0	0	1	0	1	1	1	0	1	1	1	0	0	0	0	0x1770
Input Instance 151 (NG) (Error code *)	5, 4	1	1	0	0	0	0	0	0	0	0	0	1	1	0	0	0	0xC018
	7, 6	0	0	0	1	0	0	0	1	0	0	0	0	0	0	0	1	0x1101

About byte 0 - 3, refer to section 3.4.5.2.

* Refer to following about the error code.

0x1100: Data out of range

0x1101: Bad address

3.4.5.5. Instance 102/152 - Toshiba Specific (12 bytes, parameter [2 0 3] = 4)

Byte	Bit 7	Bit 6	Bit 5	Bit 4	Bit 3	Bit 2	Bit 1	Bit 0
0	[0 0 1] Command data (Low byte)							
1	[0 0 1] Command data (High byte)							
2	[0 0 2] Command data (Low byte)							
3	[0 0 2] Command data (High byte)							
4	[0 0 3] Command data (Low byte)							
5	[0 0 3] Command data (High byte)							
6	[0 0 4] Command data (Low byte)							
7	[0 0 4] Command data (High byte)							
8	[0 0 5] Command data (Low byte)							
9	[0 0 5] Command data (High byte)							
10	[0 0 6] Command data (Low byte)							
11	[0 0 6] Command data (High byte)							

Fig. 9 Output Instance 102 Layout

Byte	Bit 7	Bit 6	Bit 5	Bit 4	Bit 3	Bit 2	Bit 1	Bit 0
0	[0 2 1] Monitor data (Low byte)							
1	[0 2 1] Monitor data (High byte)							
2	[0 2 2] Monitor data (Low byte)							
3	[0 2 2] Monitor data (High byte)							
4	[0 2 3] Monitor data (Low byte)							
5	[0 2 3] Monitor data (High byte)							
6	[0 2 4] Monitor data (Low byte)							
7	[0 2 4] Monitor data (High byte)							
8	[0 2 5] Monitor data (Low byte)							
9	[0 2 5] Monitor data (High byte)							
10	[0 2 6] Monitor data (Low byte)							
11	[0 2 6] Monitor data (High byte)							

Fig. 10 Input Instance 152 Layout

About byte 0 - 11, refer to section 3.4.5.7.

3.4.5.6. Instance 105/155 - Toshiba Specific (18 bytes, parameter [2 0 3] = 5)

Byte	Bit 7	Bit 6	Bit 5	Bit 4	Bit 3	Bit 2	Bit 1	Bit 0
0	-							
1	Read/Write command							
2	Index (Low byte)							
3	Index (High byte)							
4	Data (Low byte)							
5	Data (High byte)							
6	[0 0 1] Command data (Low byte)							
7	[0 0 1] Command data (High byte)							
8	[0 0 2] Command data (Low byte)							
9	[0 0 2] Command data (High byte)							
10	[0 0 3] Command data (Low byte)							
11	[0 0 3] Command data (High byte)							
12	[0 0 4] Command data (Low byte)							
13	[0 0 4] Command data (High byte)							
14	[0 0 5] Command data (Low byte)							
15	[0 0 5] Command data (High byte)							
16	[0 0 6] Command data (Low byte)							
17	[0 0 6] Command data (High byte)							

Fig. 11 Output Instance 105 Layout

Byte	Bit 7	Bit 6	Bit 5	Bit 4	Bit 3	Bit 2	Bit 1	Bit 0
0	-							
1	Read/Write response *							
2	Index (Low byte)							
3	Index (High byte)							
4	Data (Low byte)							
5	Data (High byte)							
6	[0 2 1] Monitor data (Low byte)							
7	[0 2 1] Monitor data (High byte)							
8	[0 2 2] Monitor data (Low byte)							
9	[0 2 2] Monitor data (High byte)							
10	[0 2 3] Monitor data (Low byte)							
11	[0 2 3] Monitor data (High byte)							
12	[0 2 4] Monitor data (Low byte)							
13	[0 2 4] Monitor data (High byte)							
14	[0 2 5] Monitor data (Low byte)							
15	[0 2 5] Monitor data (High byte)							
16	[0 2 6] Monitor data (Low byte)							
17	[0 2 6] Monitor data (High byte)							

Fig. 12 Input Instance 155 Layout

About byte 6 - 17, refer to section 3.4.5.7.

Examples of Instance 105/155

Access the inverter parameter is enabled using byte 1 to 5 of this Instance.

Set the communication number of the parameter to byte 2, 3 (Index), and the value to byte 4, 5 (Data).

① Read the parameter $\underline{C} \underline{M} \underline{D}$ (Command mode selection, communication number is 0003).

Instance	Byte	15	14	13	12	11	10	9	8	7	6	5	4	3	2	1	0	Hex.
Output Instance 105	1, 0	0	0	0	0	0	0	0	0	0	0	0	0	0	0	0	0	0x0000
	3, 2	0	0	0	0	0	0	0	0	0	0	0	0	0	0	1	1	0x0003
	5, 4	-	-	-	-	-	-	-	-	-	-	-	-	-	-	-	-	-
Input Instance 155 ($\underline{C} \underline{M} \underline{D}$ is 0.)	1, 0	0	0	0	0	0	0	0	0	0	0	0	0	0	0	0	0	0x0000
	3, 2	0	0	0	0	0	0	0	0	0	0	0	0	0	0	1	1	0x0003
	5, 4	0	0	0	0	0	0	0	0	0	0	0	0	0	0	0	0	0x0000

② Read the parameter $\underline{F} \underline{R} \underline{E} \underline{Q}$ (Initial value of UP/DOWN frequency).

Instance	Byte	15	14	13	12	11	10	9	8	7	6	5	4	3	2	1	0	Hex.
Output Instance 105	1, 0	0	0	0	0	0	0	0	0	0	0	0	0	0	0	0	0	0x0000
	3, 2	0	0	0	0	0	0	1	0	0	1	1	0	1	0	0	0	0x0268
	5, 4	-	-	-	-	-	-	-	-	-	-	-	-	-	-	-	-	-
Input Instance 155 ($\underline{F} \underline{R} \underline{E} \underline{Q}$ is 60.0Hz.)	1, 0	0	0	0	0	0	0	0	0	0	0	0	0	0	0	0	0	0x0000
	3, 2	0	0	0	0	0	0	1	0	0	1	1	0	1	0	0	0	0x0268
	5, 4	0	0	0	1	0	1	1	1	0	1	1	1	0	0	0	0	0x1770

③ Write "60 (Hz)" to the parameter $\underline{S} \underline{r} \underline{1}$ (Preset speed 1, communication number is 0018).

Instance	Byte	15	14	13	12	11	10	9	8	7	6	5	4	3	2	1	0	Hex.
Output Instance 105	1, 0	1	0	0	0	0	0	0	0	0	0	0	0	0	0	0	0	0x8000
	3, 2	0	0	0	0	0	0	0	0	0	0	0	1	1	0	0	0	0x0018
	5, 4	0	0	0	1	0	1	1	1	0	1	1	1	0	0	0	0	0x1770
Input Instance 155 (OK)	1, 0	0	0	0	0	0	0	0	0	0	0	0	0	0	0	0	0	0x0000
	3, 2	0	0	0	0	0	0	0	0	0	0	0	1	1	0	0	0	0x0018
	5, 4	0	0	0	1	0	1	1	1	0	1	1	1	0	0	0	0	0x1770
Input Instance 155 (NG) (Error code *)	1, 0	0	1	0	0	0	0	0	0	0	0	0	0	0	0	0	0	0x4000
	3, 2	0	0	0	0	0	0	0	0	0	0	0	1	1	0	0	0	0x0018
	5, 4	0	0	0	0	0	0	0	0	0	0	0	0	0	0	0	1	0x0001

*Data of "Error code"

0x0001: Error

3.4.5.7. How to use Instance 102/152, 105/155

The purposes of instances 102/152 (Byte 0 - 11) and 105/155 (Byte 6 - 17) are adjustment by real time command transmission, and the monitor of an operation state by using cyclic communication of DeviceNet.

Example 1: Command transmitting by the output Instance 102.

When you want to set "0xC400" to parameter *F A 0 6*, set "1 (*F A 0 6*)" to parameter *0 0 1*.

And Since 0 and 1 byte of the output instance 102 supports the parameter *0 0 1*, if "0xC400" is set up here, "0xC400" will be set as *F A 0 6*.

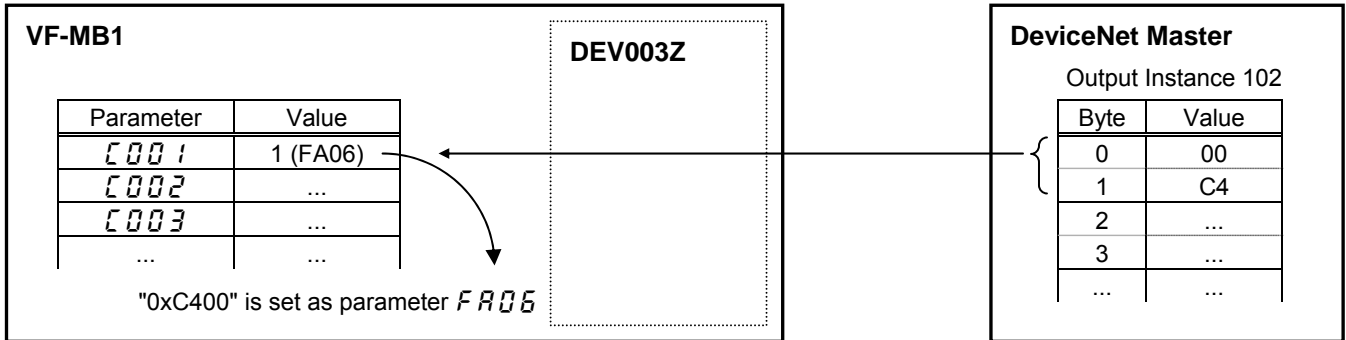

Example 2: State monitoring by the input instance 152.

When you want to monitor the output current, set "3 (*F d 0 3*)" to parameter *0 0 1*.

The value of the parameter *F d 0 3* specified as 0 and 1 byte of the input instance 152 with the parameter *0 0 1* is inputted.

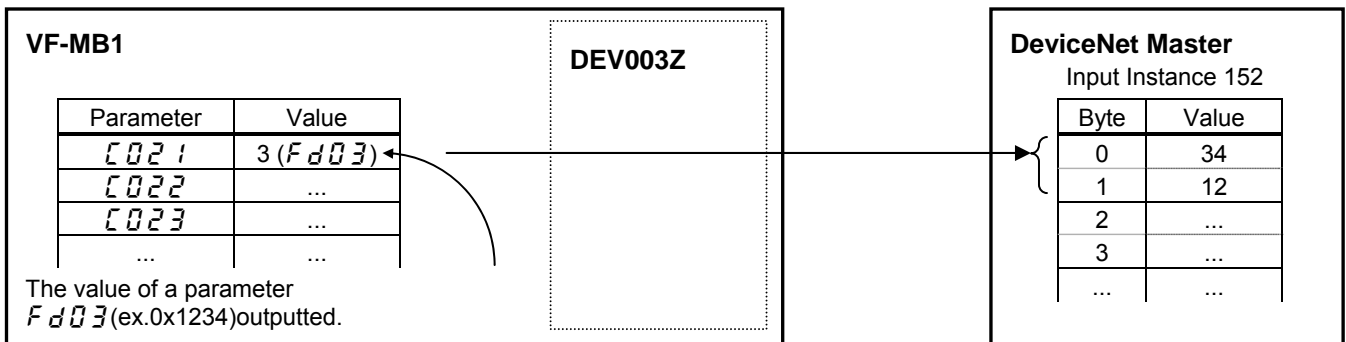

C001 - C006 setup value	C021 - C026 setup value
0: No action 1: <i>F R 0 6</i> (Communication command 1) 2: <i>F R 2 3</i> (Communication command 2) 3: <i>F R 0 7</i> (Frequency command, 0.01Hz) 5: <i>F R 5 0</i> (Terminal output data) 6: <i>F R 5 1</i> (FM analog output) 8: <i>F 5 0 1</i> (Stall prevention level, %) 13: <i>R C C</i> (Acceleration time 1, 0.1s)* 14: <i>d E C</i> (Deceleration time 1, 0.1s)* 15: <i>U L</i> (Upper limit, 0.01Hz) 16: <i>u b</i> (Torque boost value 1, 0.1%) 17: <i>u L u</i> (Base frequency voltage 1, 0.1V)	0: No action 1: <i>F d 0 1</i> (Status information 1) 2: <i>F d 0 0</i> (Output frequency, 0.01Hz) 3: <i>F d 0 3</i> (Output current, 0.01%) 4: <i>F d 0 5</i> (Output voltage, 0.01%) 5: <i>F C 9 1</i> (Alarm information) 6: <i>F d 2 2</i> (PID feedback value, 0.01Hz) 7: <i>F d 0 6</i> (Input terminal board status) 8: <i>F d 0 7</i> (Output terminal status) 9: <i>F E 3 6</i> (VIB input, 0.01%) 10: <i>F E 3 5</i> (VIA input, 0.01%) 11: <i>F E 3 7</i> (VIC input, 0.01%) 12: <i>F d 0 4</i> (Input voltage (DC detection), 0.01%) 13: <i>F d 1 6</i> (Estimated speed (real-time value), 0.01Hz) 14: <i>F d 1 8</i> (Torque, 0.01%) 19: <i>F 8 8 0</i> (Free notes) 20: <i>F d 2 9</i> (Input power, 0.01kW) 21: <i>F d 3 0</i> (Output power, 0.01kW) 22: <i>F E 1 4</i> (Cumulative operation time, hour) 23: <i>F E 4 0</i> (FM terminal output monitor, 0.01%) 25: <i>F d 2 0</i> (Torque current, 0.01%) 26: <i>F d 2 3</i> (Motor overload factor, 0.01%) 27: <i>F d 2 4</i> (Drive overload factor, 0.01%) 28: <i>F d 2 5</i> (PBR overload factor, %) 29: <i>F d 2 6</i> (Motor load factor, %) 30: <i>F d 2 7</i> (Drive load factor, %) 31: <i>F E 5 6</i> (Pulse train input, pps) 32: <i>F E 7 0</i> (Drive rated current, 0.1A) 33: <i>F E 7 6</i> (Input Watt-hour, 0.1kWh × 10 ^{f749}) 34: <i>F E 7 7</i> (Output Watt-hour, 0.1kWh × 10 ^{f749}) 35: <i>F d 8 3</i> (IGBT temperature, degree C)

*1 The unit of *R C C*, *d E C* is according to the parameter *F 5 1 9*.

*2 The unit of *F E 7 6*, *F E 7 7* is according to the parameter *F 7 4 9*.

3.4.6. The outline of the parameter *C001 - C006, C021 - C026* setup value

The outline is indicated about the setting item of parameter *C001 - C006* and *C021 - C026* in Instance 102/152 and 105/155 of use.

Please refer to a communication functional description (E6581726/E6581913) for details.

3.4.6.1. *FAD6* (Communication command1)

bit	Function	0	1	Note
0	Preset speed operation frequencies 1	Preset speed operation is disabled or preset speed operation frequencies (1-15) are set by specifying bits for preset speed operation frequencies 1-4. (0000: Preset speed operation OFF, 001-1111: Setting of preset speed operation frequencies (1-15))		
1	Preset speed operation frequencies 2			
2	Preset speed operation frequencies 3			
3	Preset speed operation frequencies 4			
4	Motor selection (1 or 2) (THR 2 selection)	Motor 1 (THR 1)	Motor 2 (THR 2)	THR 1: $Pt = \text{setting value}, tHr$ THR 2: $Pt = 0, F170, F171, F172, F173$
5	PI D control	Normal operation	PI D off	-
6	Acceleration/deceleration pattern selection (1 or 2) (AD2 selection)	Acceleration/deceleration pattern 1 (AD1)	Acceleration/deceleration pattern 2 (AD2)	AD1: <i>ACC, DEC</i> AD2: <i>F500, F501</i>
7	DC braking	OFF	Forced DC braking	-
8	Jog run	OFF	Jog run	-
9	Forward/reverse run selection	Forward run	Reverse run	-
10	Run/stop	Stop	Run	-
11	Coast stop command	Standby	Cost stop	-
12	Emergency stop	OFF	Emergency stop	Always enable, "E" trip
13	Fault reset	OFF	Reset	No data is returned from the drive
14	Frequency priority selection	OFF	Enabled	Enabled regardless of the setting of <i>FADd</i>
15	Command priority selection	OFF	Enabled	Enabled regardless of the setting of <i>CADd</i>

* VF-S15:When 14(*Sr0*) is set to *FADd*, preset speed operation frequency 0 is selected.

3.4.6.2. *FRZ3* (Communication command 2)

bit	Function	0	1	Note
0	(Reserved)	-	-	-
1	Electric power quantity reset	OFF	Reset	Electric power quantity (<i>FE76</i> , <i>FE77</i>) reset
2	(Reserved)	-	-	-
3	(Reserved)	-	-	-
4	(Reserved)	-	-	-
5	(Reserved)	-	-	-
6	(Reserved)	-	-	-
7	Maximum deceleration forced stop	Normal	Enabled	-
8	Acceleration/deceleration selection 1	00: Acceleration/deceleration 1 01: Acceleration/deceleration 2 10: Acceleration/deceleration 3		Select acceleration/deceleration 1-4 by combination of two bits.. AD1: <i>ACC, DEC</i> AD2: <i>F500, F501</i> AD3: <i>F510, F511</i>
9	Acceleration/deceleration selection 2			
10	(Reserved)			
11	(Reserved)	-	-	-
12	OC stall level switch	OC stall 1	OC stall 2	OC stall 1: <i>F601</i> OC stall 2: <i>F185</i>
13	(Reserved)	-	-	-
14	(Reserved)	-	-	-
15	(Reserved)	-	-	-

Note: Set 0 to reserved bit.

3.4.6.3. *FRQ7* (frequency reference from internal option)

Frequency reference is set up by 0.01Hz unit and the hexadecimal number.
For example, when "Frequency reference" is set up to 80Hz, since the minimum unit is 0.01Hz,
 $80 / 0.01 = 8000 = 0x1F40$ (Hex.)

3.4.6.4. *FRSQ* (Terminal output data from communication)

By setting up the data of the bit 0 - 1 of terminal output data (*FRSQ*) from communication, setting data (OFF or ON) can be outputted to the output terminal.
Please select the functional number 92 - 95 as the selection (*F130 - F138*) of the output terminal function before using it.

bit	Output TB function name	0	1
0	Specified data output 1 (Output terminal No.: 92, 93)	OFF	ON
1	Specified data output 2 (Output terminal No.: 94, 95)	OFF	ON
2-15	(Reserved)	-	-

Note: Set 0 to reserved bit

3.4.6.5. *FRS1* (Analog output (FM) data from communication)

Use this function, set the FM terminal meter selection parameter (*FRSL*) to 18 (communication data output).
This makes it possible to send out the data specified as FM analog output data (*FRS1*) though the FM analog output terminal. Data can be adjusted in a range of 0 to 1000 (resolution of 10 bit).

Please refer to "Meter setting and adjustment" Section of the VF-MB1/S15 instruction manual for details.

3.4.6.6. *F d 0 1* (Inverter operating status 1 (real time))

bit	Function	0	1	Note
0	Failure FL	No output	Under in progress	-
1	Failure	Not tripped	Tripped	Trip status includes <i>r t r y</i> and the trip retention status are also regarded as tripped statuses.
2	Alarm	No alarm	Alarm issued	-
3	Under voltage (<i>n o f f</i>)	Normal	Under voltage	-
4	Motor selection (1 or 2) (THR 2 selection)	Motor 1 (THR1)	Motor 2 (THR2)	THR1: <i>P t</i> = setting value, <i>u L</i> , <i>u L u</i> , <i>u b</i> , <i>t H r</i> THR2: <i>P t</i> = 0, <i>F 1 7 0</i> , <i>F 1 7 1</i> , <i>F 1 7 2</i> , <i>F 1 7 3</i>
5	PID control off	PID control permitted	PID control prohibits	-
6	Acceleration/deceleration pattern selection (1 or 2)	Acceleration/deceleration pattern 1 (AD1)	Acceleration/deceleration pattern 2 (AD2)	AD1: <i>A C C</i> , <i>d E C</i> AD2: <i>F 5 0 0</i> , <i>F 5 0 1</i>
7	DC braking	OFF	Forced DC braking	-
8	Jog run	OFF	Jog run	-
9	Forward / reverse run	Forward run	Reverse run	-
10	Run/stop	Stop	Run	-
11	Coast stop (ST = OFF)	ST=ON	ST=OFF	-
12	Emergency stop	No emergency stop status	Emergency stop status	-
13	Standby ST=ON	Start-up process	Standby	Standby: Initialization completed, not failure stop status, not alarm stop status (<i>n o f f</i> , <i>L L</i> forced stop), ST=ON, and RUN=ON
14	Standby	Start-up process	Standby	Standby: Initialization completed, not failure stop status and not alarm stop status (<i>n o f f</i> , <i>L L</i> forced stop)
15	(Undefined)	-	-	-

Note: The bit described "Undefined" is unstable. Don't use the bit for the judgment.

3.4.6.7. *F d 0 0* (Output frequency (real time))

The current output frequency is read into 0.01Hz of units and by the hexadecimal number. For example, when the output frequency is 80Hz, 0x1F40 (hexadecimal number) are read.

Since the minimum unit is 0.01%,
 $0x1F40 \text{ (Hex.)} = 8000 \text{ (Dec.)} * 0.01 = 80 \text{ (Hz)}$

Also about the following parameters, these are the same as this.

- *F d 2 2* (Feedback value of PID (real time)) Unit: 0.01Hz
- *F d 1 6* (Estimated speed (real time)) Unit: 0.01Hz
- *F d 2 9* (Input power (real time)) Unit: 0.01kW
- *F d 3 0* (Output power (real time)) Unit: 0.01kW

3.4.6.8. *F d 0 3* (Output current (real time))

The output current is read into 0.01% of units and by the hexadecimal number.

For example, when the output current of the rated current 4.8A drive is 50% (2.4A), 0x1388 (hexadecimal number) is read out.

Since the minimum unit is 0.01%,

$$0x1388 \text{ (Hex.)} = 5000 \text{ (Dec.)} * 0.01 = 50 \text{ (\%)}$$

Also about the following parameters, these are the same as this.

- *F d 0 5* (Output voltage (real time)) Unit: 0.01% (V)
- *F d 0 4* (Voltage at DC bus (real time)) Unit: 0.01% (V)
- *F d 1 8* (Torque) Unit: 0.01% (Nm)*

* When the motor information connected to the drive set to the parameter (*F 4 0 5* - *F 4 1 5*), torque monitor value "100%" is same as the rated torque of a motor in general.

3.4.6.9. *F E 3 5*, *F E 3 6*, *F E 3 7* (Monitoring of the analog input VIA, VIB, VIC)

VIA terminal board monitor: "Communication Number *F E 3 5*"

VIB terminal board monitor: "Communication Number *F E 3 6*"

VIC terminal board monitor: "Communication Number *F E 3 7*"

These monitors can also be used as A/D converters irrespective of the drive's control.

VIA / VIC terminal board monitor is capable of reading the data from external devices in a range of 0.01 to 100.00% (unsigned data: 0x0000 to 0x2710).

VIB terminal board monitor is capable of reading the data from external devices in a range of -100.00 to 100.00% (signed data: 0xD8F0 to 0x2710).

If analog input mode is selected with the frequency setting mode selection parameter, however, keep in mind that any data entered via an analog terminal is regarded as a frequency command.

3.4.6.10. *F E 1 4* (Cumulative run time)

The operated cumulative time is read by the hexadecimal number.

For example, when cumulative operation time is 18 hours, 0x12 (18 hours) is read.

$$0x12 \text{ (Hex.)} = 18 \text{ (Dec., hour)}$$

3.4.6.11. *F E 4 0* (Analog output (FM))

The output value of FM terminal is read.

The value range is set to 0 to 10000 (0x2710).

3.4.6.12. *F L 9 1* (Alarm code)

bit	Function	0	1	Remarks (Code displayed on the panel)
0	Over-current alarm	Normal	Alarming	<i>L</i> flicking
1	Inverter over load alarm	Normal	Alarming	<i>L</i> flicking
2	Motor over load alarm	Normal	Alarming	<i>L</i> flicking
3	Over heat alarm	Normal	Alarming	<i>H</i> flicking
4	Over voltage alarm	Normal	Alarming	<i>P</i> flicking
5	Main circuit undervoltage alarm	Normal	Alarming	-
6	main device overheat alarm	Normal	Alarming	<i>L</i> flicking
7	Under current alarm	Normal	Alarming	-
8	Over-torque alarm	Normal	Alarming	-
9	Braking resistor overload alarm	Normal	Alarming	-
10	Cumulative operation hours alarm	Normal	Alarming	-
11	Option communication alarm	Normal	Alarming	-
12	Serial communication alarm	Normal	Alarming	-
13	MOFFMS (MSrelay off or MOFF)	Normal	Alarming	-
14	Stop after instantaneous power off	-	Dec., Under stop	Refer to <i>F 3 0 2</i> value
15	Stop after LL continuance time	-	Dec., Under stop	Refer to <i>F 2 5 6</i> value

3.4.6.13. *F d 0 6* (Input TB Status)

bit	TB Name	Function (Parameter)	0	1
0	F	Input terminal function selection 1 (<i>F 1 1 1</i>)	OFF	ON
1	R	Input terminal function selection 2 (<i>F 1 1 2</i>)		
2	RES	Input terminal function selection 3 (<i>F 1 1 3</i>)		
3	S1	Input terminal function selection 4 (<i>F 1 1 4</i>)		
4	S2	Input terminal function selection 5 (<i>F 1 1 5</i>)		
5	S3	Input terminal function selection 6 (<i>F 1 1 6</i>)		
6	VIB*1	Input terminal function selection 7 (<i>F 1 1 7</i>)		
7	VIA*1	Input terminal function selection 8 (<i>F 1 1 8</i>)		
5 to 15	(Undefined)	-	-	-

Note: The bit described "Undefined" is unstable. Do not use the bit for the judgment.

*1: VIA/ VIB are input terminal function when *F 1 0 9* is logic input.

*The input terminal function is selected by each parameter.

3.4.6.14. *F d 0 7* (Output TB Status)

bit	TB Name	Function (Parameter)	0	1
0	RY-RC	Output terminal function selection 1A (<i>F 1 3 0</i>)	OFF	ON
1	OUT	Output TB Function select 2A (<i>F 1 3 1</i>)	OFF	ON
2	FL	Output TB Function select 3 (<i>F 1 3 2</i>)	OFF	ON
3 - 15	(Undefined)	-	-	-

Note: The bit described "Undefined" is unstable. Do not use the bit for the judgment.

3.5. Connection Object

Class code 0x05. The Connection Class allocates and manages the internal resources associated with both I/O and Explicit Messaging Connections.

3.5.1. Connection Object Attributes

Attribute ID	Name	Data Type	Access Rules	Description	Default Value
1	Revision	UINT	Get	Revision of this object.	1
2	Max instance	UINT	Get	Maximum instance number of an object currently created in this class level of the device	-

3.5.2. Connection Object Instance Attributes

Connection Instance ID #	Description
1	References the Explicit Messaging Connection (refer to 3.5.2.1).
2	Reference the Polled I/O Connection(refer to 3.5.2.3).
4	Reference the COS/Cyclic Connection(refer to 3.5.2.5).

3.5.2.1. Explicit Messaging Connection Object Instance Attributes (Instance 1)

Attribute ID	Name	Data Type	Access Rules	Description	Default Value
1	State	USINT	Get	State of the object 00 = Non-existent 01 = Configuring 02 = Waiting for connection ID 03 = Established 04 = Timed Out 05 = Deferred Delete	-
2	Instance_type	USINT	Get	Indicates connection type	0 { Explicit Message }
3	TransportClass_trigger	USINT	Get	Connection behavior	0x83 { Server Transport Class 3 }
4	Produced_connection_id	UINT	Get	Placed in CAN ID field when transmitting	-
5	Consumed_connection_id	UINT	Get	CAN ID field value denoting received messages	-
6	Initial_comm_characteristics	USINT	Get	Defines producing / consuming message groups	0x21 { Send: Gr. 2 } { Resp: Gr. 2 }
7	Produced_connection_size	UINT	Get	Max number of bytes transmitted across this connection	39
8	Consumed_connection_size	UINT	Get	Max number of bytes received across this connection	39
9	Expected_packet_rate	UINT	Get/Set	Defines timing associated with this connection	(0)
12	Watchdog_timeout_action	USINT	Get/Set	Inactivity/watchdog timeout action	1 (Auto Delete)
13	Produced_connection_path_length	UINT	Get	Number of bytes in produced_connection_path attribute	0
14	Produced_connection_path	USINT (ARRAY)	Get	Specifies Application Object(s) whose data is to be produced by this connection	Empty
15	Consumed_connection_path_length	UINT	Get	Number of bytes in consumed_connection_path attribute	0
16	Consumed_connection_path	USINT (ARRAY)	Get	Specifies Application Object(s) whose data is to be consumed by this connection	Empty
18	Connection_multiplier_timeout	USINT	Get/Set	Specifies the multiplier to the expected_packet_rate value to derive the value for the Inactivity/Watchdog Timer	0

3.5.2.2. Connection Class Common Services

Service Code	Service Name	Supported		Description of Service
		Class	Instance	
0x05	Reset	N/A	Yes	Used to reset all resetable connection objects.
0x0E	Get_Attribute_Single	Yes	Yes	Returns the contents of the specified attribute.
0x10	Set_Attribute_Single	N/A	Yes	Modifies the value of the specified attribute.

3.5.2.3. Poll Connection Object Instance Attributes (Instance 2)

Attribute ID	Name	Data Type	Access Rules	Description	Default Value
1	State	USINT	Get	State of the object 00 = Non-existent 01 = Configuring 02 = Waiting for connection ID 03 = Established 04 = Timed Out 05 = Deferred Delete	-
2	Instance_type	USINT	Get	Indicates connection type	1 (I/O)
3	TransportClass_trigger	USINT	Get	Connection behavior	0x82 [Server Transport Class 2]
4	Produced_connection_id	UINT	Get	Placed in CAN ID field when transmitting	-
5	Consumed_connection_id	UINT	Get	CAN ID field value denoting received messages	-
6	Initial_comm_characteristics	USINT	Get	Defines producing / consuming message groups	0x1 [Send: Gr. 1 Resp: Gr. 2]
7	Produced_connection_size	UINT	Get	Max number of bytes transmitted across this connection	4
8	Consumed_connection_size	UINT	Get	Max number of bytes received across this connection	4
9	Expected_packet_rate	UINT	Get/Set	Defines timing associated with this connection	(2500)
12	Watchdog_timeout_action	USINT	Get	Inactivity/watchdog timeout action	0 (Timed Out)
13	Produced_connection_path_length	UINT	Get	Number of bytes in produced_connection_path attribute	7
14	Produced_connection_path	USINT (ARRAY)	Get	Specifies Application Object(s) whose data is to be produced by this connection	0x20 0x04 0x25 0x46 0x00 0x30 0x03 [Instance 70]
15	Consumed_connection_path_length	UINT	Get	Number of bytes in consumed_connection_path attribute	7
16	Consumed_connection_path	USINT (ARRAY)	Get	Specifies Application Object(s) whose data is to be consumed by this connection	0x20 0x04 0x25 0x14 0x00 0x30 0x03 [Instance 20]
17	Production_inhibit_time	UINT	Get	Defines minimum time between new data production	0
18	Connection_multiplier_timeout	USINT	Get/Set	Specifies the multiplier to the expected_packet_rate value to derive the value for the Inactivity/Watchdog Timer	0

3.5.2.4. Connection Class Common Services

Service Code	Service Name	Supported		Description of Service
		Class	Instance	
0x05	Reset	Yes	Yes	Used to reset all resetable connection objects.
0x0E	Get_Attribute_Single	Yes	Yes	Returns the contents of the specified attribute.
0x10	Set_Attribute_Single	N/A	Yes	Modifies the value of the specified attribute.

3.5.2.5. COS/Cyclic Connection Object Instance Attributes (Instance 4)

Attribute ID	Name	Data Type	Access Rules	Description	Default Value
1	State	USINT	Get	State of the object 00 = Non-existent 01 = Configuring 02 = Waiting for connection ID 03 = Established 04 = Timed Out 05 = Deferred Delete	-
2	Instance_type	USINT	Get	Indicates connection type	1 (I/O)
3	TransportClass_trigger	USINT	Get	Connection behavior	0x12 [Client Transport Class 2]
4	Produced_connection_id	UINT	Get	Placed in CAN ID field when transmitting	-
5	Consumed_connection_id	UINT	Get	CAN ID field value denoting received messages	-
6	Initial_comm_characteristics	USINT	Get	Defines producing / consuming message groups	0x01 [Send: Gr. 1 Resp: Gr. 2]
7	Produced_connection_size	UINT	Get	Max number of bytes transmitted across this connection	4
8	Consumed_connection_size	UINT	Get	Max number of bytes received across this connection	0
9	Expected_packet_rate	UINT	Get/Set	Defines timing associated with this connection	(0)
12	Watchdog_timeout_action	USINT	Get	Inactivity/watchdog timeout action	0 (Timed Out)
13	Produced_connection_path_length	UINT	Get	Number of bytes in produced_connection_path attribute	7
14	Produced_connection_path	USINT (ARRAY)	Get	Specifies Application Object(s) whose data is to be produced by this connection	0x20 0x04 0x25 0x46 0x00 0x30 0x03 [Instance 70]
15	Consumed_connection_path_length	UINT	Get	Number of bytes in consumed_connection_path attribute	5
16	Consumed_connection_path	USINT (ARRAY)	Get	Specifies Application Object(s) whose data is to be consumed by this connection	0x20 0x2B 0x25 0x01 0x00
17	Production_inhibit_time	UINT	Get/Set	Defines minimum time between new data production	0
18	Connection_multiplier_timeout	USINT	Get/Set	Specifies the multiplier to the expected_packet_rate value to derive the value for the Inactivity/Watchdog Timer.	0

3.5.2.6. Connection Class Common Services

Service Code	Service Name	Supported		Description of Service
		Class	Instance	
0x05	Reset	Yes	Yes	Used to reset all resetable connection objects.
0x0E	Get_Attribute_Single	Yes	Yes	Returns the contents of the specified attribute.
0x10	Set_Attribute_Single	N/A	Yes	Modifies the value of the specified attribute.

3.6. Motor Data Object

Class code 0x28. This object serves as a database for motor parameters.

3.6.1. Motor Data Object Class Attributes

Attribute ID	Name	Data Type	Access Rules	Description	Default Value
1	Revision	UINT	Get	Revision of this object	1
2	Max instance	UINT	Get	Maximum instance number of an object currently created in this class level of the device	1
6	Max ID of class attributes	UNIT	Get	The attribute ID number of the last class attribute of the class definition implemented in the device.	7
7	Max ID of instance attributes	UNIT	Get	The attribute ID number of the last instance attribute of the class definition implemented in the device.	15

3.6.2. Motor Data Object Instance Attributes

Attribute ID	Name	Data Type	Access Rules	Description	Default Value
1	Number of Attributes	USINT	Get	Number of Attributes supported	9
2	Attributes List	USINT (ARRAY)	Get	List of attributes supported	-
3	Motor Type	USINT	Get	0 - Non-standard motor 1 - PM DC Motor 2 - FC DC Motor 3 - PM Synchronous Motor 4 - FC Synchronous Motor 5 - Switched Reluctance Motor 6 - Wound Rotor Induction Motor 7 - Squirrel Cage Induction Motor 8 - Stepper Motor 9 - Sinusoidal PM BL Motor 10 - Trapezoidal PM BL Motor	7
6	Rated Current	UINT	Get/Set	Rated Current [100mA]	-
7	Rated Voltage	UINT	Get/Set	Rated Voltage [V]	-
8	Rated Power	UDINT	Get/Set	Power at rated frequency [W]	-
9	Rated Frequency	UINT	Get/Set	Rated Electrical Frequency [Hz]	-
12	Pole Count	UINT	Get	Number of poles in the motor	-
15	Base Speed	UINT	Get/Set	Nominal speed at rated frequency from nameplate [min^{-1}]	-

3.6.3. Motor Data Object Common Services

Service Code	Service Name	Supported		Description of Service
		Class	Instance	
0x0E	Get_Attribute_Single	N/A	Yes	Returns the contents of the specified attribute.
0x10	Set_Attribute_Single	N/A	Yes	Modifies the value of the specified attribute.

3.6.4. Motor Data Object Specific Services

Motor Data Object provides no object specific services.

3.7. Control Supervisor Object

Class code 0x29. This object models all the management functions for devices within the DeviceNet “Hierarchy of Motor Control Devices”. The behavior of motor control devices is described by the State Transition Diagram.

3.7.1. Control Supervisor Object Class Attributes

Attribute ID	Name	Data Type	Access Rules	Description	Default Value
1	Revision	UINT	Get	Revision of this object	1
2	Max instance	UINT	Get	Maximum instance number of an object currently created in this class level of the device	1
6	Max ID of class attributes	UNIT	Get	The attribute ID number of the last class attribute of the class definition implemented in the device.	7
7	Max ID of instance attributes	UNIT	Get	The attribute ID number of the last instance attribute of the class definition implemented in the device.	15

3.7.2. Control Supervisor Object Instance Attributes

Attribute ID	Name	Data Type	Access Rules	Description	Default Value
1	Number of Attributes	USINT	Get	Number of Attributes supported	13
2	Attribute List	USINT (ARRAY)	Get	List of attributes supported	-
3	Run 1	BOOL	Get/Set	See Run/Stop Event Matrix 00 = Stop 01 = Run	-
4	Run 2	BOOL	Get/Set	See Run/Stop Event Matrix 00 = Stop 01 = Run	-
5	Net Control	BOOL	Get/Set	Requests Run/Stop control to be local or from network. 0 = Local Control 1 = Network Control Note that the actual status of Run/Stop control is reflected in attribute 15, CtrlFromNet.	-
6	State	USINT	Get	0 = Vendor Specific 1 = Startup 2 = Not_Ready 3 = Ready 4 = Enabled 5 = Stopping 6 = Fault_Stop 7 = Faulted	-
7	Running 1	BOOL	Get	1 = (Enabled and Run1) or (Stopping and Running1) or (Fault_Stop and Running1) 0 = Other state	-
8	Running 2	BOOL	Get	1 = (Enabled and Run2) or (Stopping and Running2) or (Fault_Stop and Running2) 0 = Other state	-
9	Ready	BOOL	Get	1 = Ready or Enabled or Stopping 0 = Other state	-
10	Faulted	BOOL	Get	1 = Fault Occurred (latched) 0 = No Faults present	-
11	Warning	BOOL	Get	1 = Warning (not latched) 0 = No Warnings present	-
12	Fault Reset	BOOL	Get/Set	0->1 = Fault Reset 0 = No action	-
15	Control From Net	USINT	Get	Status of Run/Stop control source. 0 = Control is local 1 = Control is from network	-

3.7.3. Control Supervisor Object Common Services

Service Code	Service Name	Supported		Description of Service
		Class	Instance	
0x05	Reset	N/A	Yes	Used to reset all resettable connection objects.
0x0E	Get_Attribute_Single	N/A	Yes	Returns the contents of the specified attribute.
0x10	Set_Attribute_Single	N/A	Yes	Modifies the value of the specified attribute.

3.7.4. Control Supervisor Object Specific Services

The Control Supervisor Object provides no object specific services.

3.7.5. Run/Stop Event Matrix

Run1	Run2	Trigger Event	Run Type
0	0	Stop	No Action
0 -> 1	0	Run	Run1
0	0 -> 1	Run	Run2
0 -> 1	0 -> 1	No Action	No Action
1	1	No Action	No Action
1 -> 0	1	Run	Run2
1	1 -> 0	Run	Run1

3.7.6. Control Supervisor State Transition Diagram

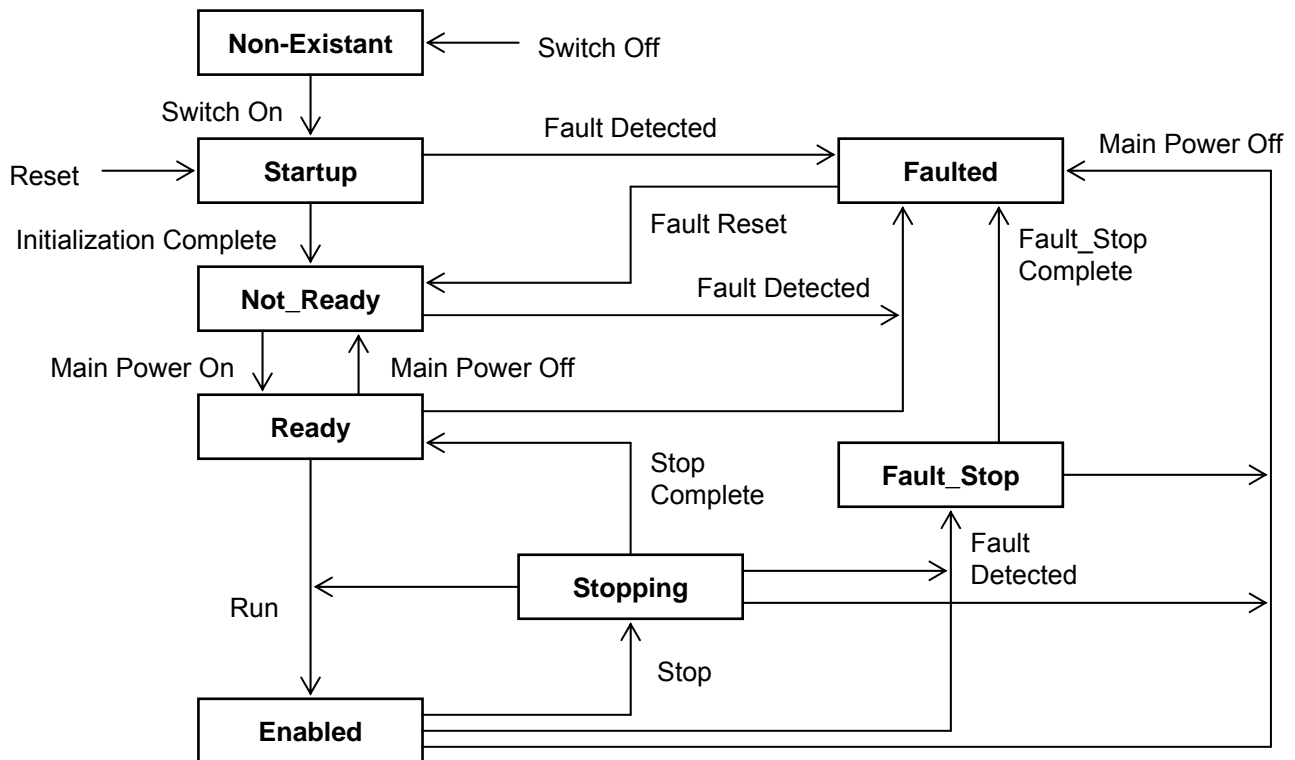

3.8. AC/DC Drive Object

Class code 0x2A. This object models the functions specific to an AC or DC Drive. e.g. speed ramp, torque control etc.

3.8.1. AC/DC Drive Object Class Attributes

Attribute ID	Name	Data Type	Access Rules	Description	Default Value
1	Revision	UINT	Get	Revision of this object	1
2	Max instance	UINT	Get	Maximum instance number of an object currently created in this class level of the device	1
6	Max ID of class attributes	UNIT	Get	The attribute ID number of the last class attribute of the class definition implemented in the device.	7
7	Max ID of instance attributes	UNIT	Get	The attribute ID number of the last instance attribute of the class definition implemented in the device.	46

3.8.2. AC/DC Drive Object Instance Attributes

Attribute ID	Name	Data Type	Access Rules	Description	Default Value
1	Number of Attributes	USINT	Get	Number of Attributes supported	19
2	Attribute List	USINT (ARRAY)	Get	List of Attributes supported	-
3	At Reference	BOOL	Get	1 = Drive actual at reference (speed or torque reference) based on mode	-
4	Net Reference	BOOL	Get/Set	Requests torque or speed reference to be local or from network. 0 = Set Reference not DN Control 1 = Set Reference at DN Control Note that the actual status of torque or speed reference is reflected in attribute 29, RefFromNet.	-
6	Drive Mode	USINT	Get	0 = Vendor specific mode 1 = Open loop speed (Frequency) 2 = Closed loop speed control 3 = Torque control 4 = Process control (e.g. PI) 5 = Position control	-
7	Speed Actual	INT	Get	Actual drive speed (best approximation) Units: min ⁻¹	-
8	Speed Reference	INT	Get/Set	Speed reference Units: min ⁻¹	-
9	Current Actual	INT	Get	Actual motor phase current Units: 100mA	-
10	Current Limit	INT	Get/Set	Motor phase current limit Units: 100mA	-
11	Torque Actual	INT	Get	Actual torque Units: Nm	-
15	Power Actual	INT	Get	Actual output power Units: W/2 ^{PowerScale}	-
18	Accel Time	UINT	Get/Set	Acceleration time Time from 0 to High Speed Limit Units: ms/2 ^{TimeScale}	-
19	Decel Time	UINT	Get/Set	Acceleration time Time from 0 to High Speed Limit Units: ms/2 ^{TimeScale}	-
20	Low Speed Limit	UINT	Get/Set	Minimum speed limit Units: min ⁻¹	-
21	High Speed Limit	UINT	Get/Set	Maximum speed limit Units: min ⁻¹	-
26	Power Scale	SINT	Get	Power scaling factor.	0
28	Time Scale	SINT	Get/Set	Time scaling factor.	0
29	Ref From Net	BOOL	Get	Status of torque/speed reference 0 = Local torque/speed reference 1 = DeviceNet torque/speed reference	-
46	Drive on Hours	DINT	Get	Number of hours Units: h	-

3.8.3. AC/DC Drive Object Common Services

Service Code	Service Name	Supported		Description of Service
		Class	Instance	
0x0E	Get_Attribute_Single	Yes	Yes	Returns the contents of the specified attribute.
0x10	Set_Attribute_Single	N/A	Yes	Modifies the value of the specified attribute.

3.8.4. AC/DC Drive Object Specific Services

AC/DC Drive Object provides no object specific services for the slave.

3.9. Acknowledge Handler Object

Class code 0x2B. This object is used to manage the reception of message acknowledgements. This object communicates with a message producing Application Object within a device.

3.9.1. Acknowledge Handler Object Class Attributes

Attribute ID	Name	Data Type	Access Rules	Description	Default Value
1	Revision	UINT	Get	Revision of this object	1
2	Max instance	UINT	Get	Maximum instance number of an object currently created in this class level of the device	1

3.9.2. Acknowledge Handler Object Instance Attributes

Attribute ID	Name	Data Type	Access Rules	Description	Default Value
1	Acknowledge timer	UINT	Get/Set	Time to wait for acknowledge before resending	(16)
2	Retry limit	USINT	Get/Set	Number of Ack Timeouts to wait before informing the producing application of a RetryLimit Reached event.	1
3	COS producing connection instance	UINT	Get	Connection Instance which contains the path of the producing I/O application object which will be notified of Ack Handler events.	(Connection Instance ID)

3.9.3. Acknowledge Handler Object Common Services

Service Code	Service Name	Supported		Description of Service
		Class	Instance	
0x0E	Get_Attribute_Single	Yes	Yes	Returns the contents of the specified attribute.
0x10	Set_Attribute_Single	N/A	Yes	Modifies the value of the specified attribute.

3.9.4. Acknowledge Handler Object Specific Services

Acknowledge Handler Object provides no object specific services.

3.10. Parameter Object (Vender Specific Profiles)

Class code 0x65. This object provides VF-MB1/S15's parameter access.

Drive parameter's Attribute ID is 3, VF-MB1/S15's parameter is set as Instance ID.

For example, in case of set 5 sec. to "Acc. time", the minimum unit of "Acc. time" is 0.1 sec., the set vlaue is

$$5 / 0.1 = 50 = 0x0032 \text{ (Hex.)}$$

And the communication number of "Acc. time" is "0009".

So, set the value 0x0032 to Class 0x65, Instance 0009, Attribute 3 to use Set Single Attribute service.

* Parameter *RU* ! can not be accessed by using Class 0x65. Please, use Class 0x64.

Also, Class 0x64 at the previous model is supported. All parameter's Attribute ID is 3.

The instance ID should be set " VF-MB1 or VF-S15 parameter communication number + 0x4000".

In the case of the parameter from which a communication number begins in "F", it should be set "VF-MB1/S15 parameter communication number - 0x8000".

Example 1.

In case of Basic parameter "CMOd - Command mode selection",

Communication No: 0003 -> Instance ID: 4003

Example 2.

In case of Extended parameter "F268 - Updown frequency default value",

Communication No: 0268 -> Instance ID: 4268

Example 3.

In case of Monitor parameter "FE03 - Output current",

Communication No: FE03 -> Instance ID: 7E03

* Monitor parameter can access "Get" only.

Notice

- ◆ These procedure writes in EEPROM.
- ◆ Do not write the same parameter to the EEPROM more than 10,000 times.
The life time of EEPROM is approximately 10,000 times.

4. DeviceNet Local/Remote Operation

The example below shows how to configure the VF-MB1/S15 for local / remote operation.

<Terminal function>

- F terminal RUN command
- R terminal..... DeviceNet /Local (Terminal in this example) switching
- VIB terminal..... Operation frequency command

<Wiring>

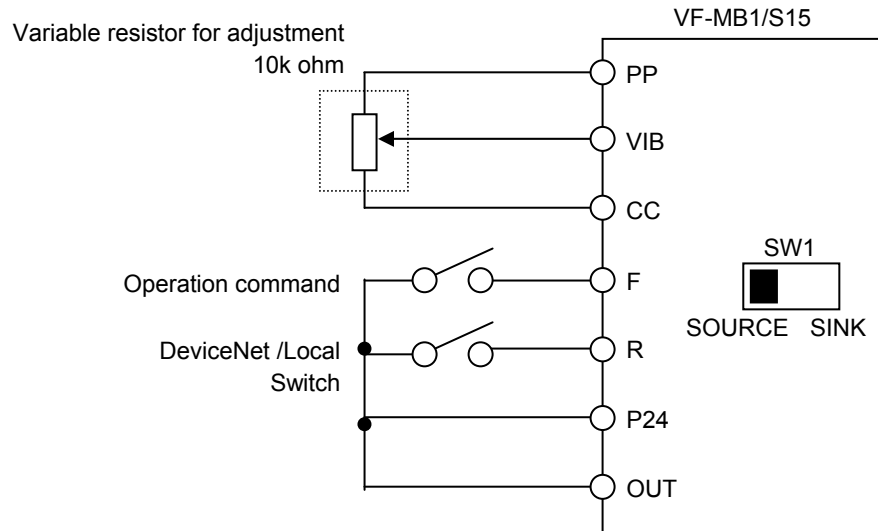

<Parameter setting>

- cmod (command mode selection) = 0 (terminal board)
- fmod (frequency setting mode selection 1) = 2 (VIB)
- f112 (input terminal selection 2 (R)) = 48 (DeviceNet/Local control)

<Operation>

- R-CC terminal open:
 - VF-MB1 is controlled as slave device of DeviceNet.
- R-CC terminal closed:
 - F-CC terminal short to RUN
 - F-CC terminal open to STOP
 - Output frequency is set up by the VIB signal input.

5. EDS file

Even if access to each parameter of VF-MB1 or VF-S15 uses a configuration tool and an EDS file, it is possible. As for acquisition of an EDS file, please contact your Toshiba distributor.

Please use what was in agreement with the software version of usage's VF-MB1 or VF-S15.