

**TOSVERT VF-MB1/S15 series**

---

**EtherCAT<sup>®</sup> option unit Function Manual**

---

**IPE003Z**

---

**NOTICE**

1. Read this manual before installing or operating. Keep this instruction manual on hand of the end user, and make use of this manual in maintenance and inspection.
2. All information contained in this manual will be changed without notice. Please contact your Toshiba distributor to confirm the latest information.

---

## Introduction

---

Thank you for purchasing the “EtherCAT® option (IPE003Z)” for TOSVERT VF-MB1/S15 drive. Before using EtherCAT® module, carefully read this function manual in order to completely and correctly utilize its excellent performance.

This option needs the option adaptor to connect VF-S15 which type form is SBP009Z. Please match here and buy it when SBP009Z is not at hand yet.

After reading this function manual, please keep it handy for future reference.

For details of its general handling, see an instruction manual attached with the option unit.

- TOSVERT VF-MB1 Instruction Manual ..... E6581697
- TOSVERT VF-S15 Instruction Manual ..... E6581611
- TOSVERT VF-MB1/S15 communication option Precautions Manual ..... E6581739
- TOSVERT VF-MB1 Communication Function Instruction Manual ..... E6581726
- TOSVERT VF-S15 Communication Function Instruction Manual ..... E6581913
- VF-S15 Option Adapter Instruction Manual ..... E6581838

EtherCAT® is a registered trademark and patented technology, licensed by Beckhoff Automation GmbH, Germany.

### **Profile**

The VF-MB1/S15 supports CiA®402 V3 drive profile, using CoE(CANOpen Over EtherCAT)

### **BECKHOFF® software**



The VF-MB1/S15 communication card supports BECKHOFF software TwinCAT® V2.x with CodeSys V2.

### **Further reading**





Recommended literature for further reading

EtherCAT Technology Group (ETG), see “[www.ethercat.org](http://www.ethercat.org)”

■ Handling in general

 <b>Warning</b>	
 Prohibited	▼ Do not connect or disconnect a network cable while the drive power is on. It may lead to electric shocks or fire.
 Mandatory	▼ See the instruction manual attached with the option unit for cautions the handling. Otherwise, it may lead to electric shocks, fire, injuries or damage to product.

■ Network control

 <b>Warning</b>	
 Prohibited	▼ Do not send the value out of the valid range to objects and attributes. Otherwise, the motor may suddenly start/stop and that may result in injuries.
 Mandatory	▼ Use an additional safety device with your system to prevent a serious accident due to the network malfunctions. Usage without an additional safety device may cause an accident.
 <b>Caution</b>	
 Mandatory	<p>▼ Set up “Communication error trip function (see below)” to stop the drive when the option unit is deactivated by an unusual event such as tripping, an operating error, power outage, failure, etc.</p> <ul style="list-style-type: none"> <li>- Network Time-Out, drive operation at disconnection, Preset speed operation selection</li> </ul> <p>(Refer to "3.3.1 Network error detection (C 100 - C 103)" for details)</p> <p>Deactivated the option module may cause an accident, if the “Communication error trip function” is not properly set up.</p> <p>▼ Make sure that the operation signals are STOP before resetting drive’s fault. The motor may suddenly start and that may result in injuries.</p>

■ Notes on operation

<b>Notes</b>	
	<p>▼ When the control power is shut off by the instantaneous power failure, communication will be unavailable for a while.</p> <p>▼ The Life of EEPROM is approximately 100,000 times. Avoid writing a command more than 100,000 times to the same parameter of the drive and the option module.</p>

# Table of Contents

<b>1. OVERVIEW</b> .....	<b>5</b>
1.1. Communication and Services .....	5
<b>2. NAMES AND FUNCTIONS</b> .....	<b>6</b>
2.1. Outline .....	6
2.2. RJ45 connector pin layout .....	7
2.3. LED indicator .....	8
<b>3. PARAMETERS</b> .....	<b>9</b>
3.1. Communication parameters .....	9
3.2. Communication parameters for IPE003Z .....	9
3.3. The details of the parameter setting .....	12
3.3.1. Network error detection (E 100 - E 103) .....	12
<b>4. COMMUNICATION OBJECT</b> .....	<b>13</b>
4.1. Communication Profile .....	13
4.2. RPDO: Receive PDO .....	14
4.3. TPDO: Transmit PDO .....	14
4.4. MB1/S15 specific profile .....	14
4.5. Application Profile (CiA402) .....	15
4.6. Abort code (CiA 301) .....	16
<b>5. DRIVE PROFILE</b> .....	<b>17</b>
5.1. CiA 402 Drive profile .....	17
5.2. TOSHIBA Drive profile .....	17
<b>6. CIA<sup>®</sup> 402 – IEC61800-7 FUNCTIONAL PROFILE</b> .....	<b>24</b>
6.1. Velocity mode object .....	24
6.1.1. CiA 402 profile .....	24
6.1.2. TOSHIBA drive profile .....	25
6.1.3. Object 0x6040: Controlword .....	26
6.1.4. Object 6041: Statusword .....	26
6.1.5. CiA402 State Chart .....	28
6.1.6. Object 0x6042: vl_target_velocity .....	30
6.1.7. Object 0x6043: vl_velocity_demand .....	30
6.1.8. Object 0x6044: vl_velocity_actual_value .....	30
6.1.9. Object 0x6046: vl_velocity_min_max_amount .....	30
6.1.10. Object 0x6048: vl_velocity_acceleration .....	31
6.1.11. Object 0x6049: vl_velocity_deceleration .....	31
6.1.12. Object 0x604A: vl_velocity_quick_stop .....	31
6.1.13. Object 0x605A: Quick stop option code .....	31
6.1.14. Object 0x6060: Mode of operation .....	32
6.1.15. Object 0x6061: Mode of operation display .....	32
6.1.16. Object 0x6502: Supported drive mode .....	32
6.2. Object 603F: Error Code .....	33
<b>7. ETHERCAT STATE MACHINE (ESM)</b> .....	<b>34</b>
<b>8. EXAMPLE: VF-MB1 WITH TWINCAT<sup>®</sup> “PLC - CONFIGURATION”</b> .....	<b>36</b>
8.1. Hardware .....	36
8.2. TwinCAT <sup>®</sup> software installation .....	36
8.3. ESI file (EtherCAT Slave Information) .....	36
8.4. MB1 configuration .....	36
8.5. System Manager: Declare your computer on Ethernet network .....	37
8.6. System Manager: Install the master .....	38
8.7. System Manager – Install the slave: MB1 in “PLC- configuration” .....	40
8.8. PLC – Control: initialization .....	41

8.9.	PLC – Control: Declare the variables.....	42
8.10.	System Manager – Append PLC Project.....	43
8.11.	PLC - Control: new compilation.....	45
8.12.	System Manager: Activate configuration.....	45
8.13.	PLC - Control: new compilation.....	45
8.14.	PLC - Control: start and stop the motor.....	45
8.15.	PLC - Control: add a library for other services.....	46
8.16.	Method of add the PDOs.....	47

# 1. Overview

The EtherCAT<sup>®</sup> interface (IPE003Z) allows the VF-MB1/S15 drive to be connected into the EtherCAT<sup>®</sup> network.



## 1.1. Communication and Services

### Cyclical Communication: PDO

- PDO is intended for use with the communication scanner according to CiA402.
- PDO provides scan cycle optimization which allows short reaction time application (< 5 ms).
- PDO overview (default settings)

<b>RPDO</b>	(CMD)	(LFRD)	(None)	(None)	(None)	(None)
<b>TPDO</b>	(ETA)	(RFRD)	(None)	(None)	(None)	(None)

CMD: Controlword

LFRD: VI\_Target\_Velocity

ETA: Statusword

RFRD: VI\_Velocity\_Actual value

The configuration means are:

- EtherCAT configuration tool, then the configuration is downloaded by the master,

### Acyclic Services: SDO

The VF-MB1/S15 manages a SDO server (Service Data Object). SDO telegrams are used for configuration and adjustment, they are characterized by two identifiers:

- One for requests (telegrams sent from the PLC to the VF-MB1/S15)
- One for responses (telegrams sent back to the PLC by the VF-MB1/S15)

### Other Supported Services

Assignment by default of address-based identifiers.

- EtherCAT state machine commands
- Emergency (EMCY)

### ESI file (EtherCAT Slave Information)

Download the ESI file in XML format for VF-MB1 and VF-S15 on [www.inverter.co.jp](http://www.inverter.co.jp).

## 2. Names and functions

The drawing below shows names and functions of main parts.

### 2.1. Outline

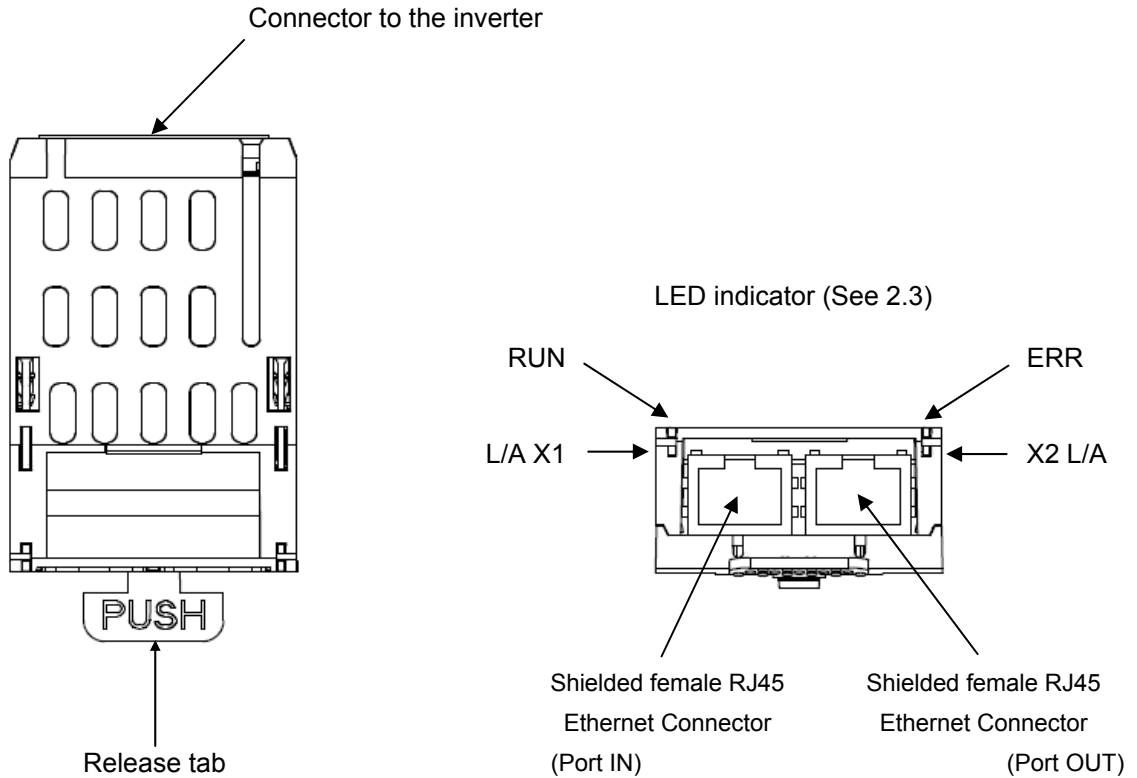

X1 means EtherCAT IN port,  
X2 means EtherCAT OUT port



## 2.2. RJ45 connector pin layout

The EtherCAT<sup>®</sup> unit is equipped with two shielded RJ45 connectors. When you use VF-MB1, the shielding is connected to the drive ground. When you use VF-S15, the shielding is connected to the grounding terminal of option adapter.

Use an STP (shielded twisted pair) Ethernet cable.

The transmission speed is detected automatically by the card (10 Mbps or 100 Mbps).

The card can operate in half duplex or full duplex mode, whether connected to a hub or a switch and regardless of the transmission speed (10 Mbps or 100 Mbps).

Port IN (L/A X1 EtherCAT)  
and Port OUT (X2 L/A EtherCAT)

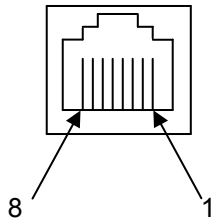

Pin	Signal	Meaning
1	TX+	Ethernet transmit line +
2	TX-	Ethernet transmit line -
3	RX+	Ethernet receive line +
4	-	
5	-	
6	RX-	Ethernet receive line -
7	-	
8	-	

\* Fix a cable so that a communication connector may be not taken the weight of wire.

### Cable specifications

- Minimum Cat 5e,
- Use equipotential bonding conductors,
- Connector RJ45, no crossover cable
- Shield: both ends grounded
- Twisted pair cable
- Cable: 8 x 0.25 mm<sup>2</sup> (8 x AWG 22)
- Use pre-assembled cables to reduce the wiring mistakes,
- Verify that wiring, cables and connected interfaces meet the PELV requirements.
- Maximum cable length = 100 m (328 ft)



### 2.3. LED indicator

The LEDs shows the present status of the network and module.

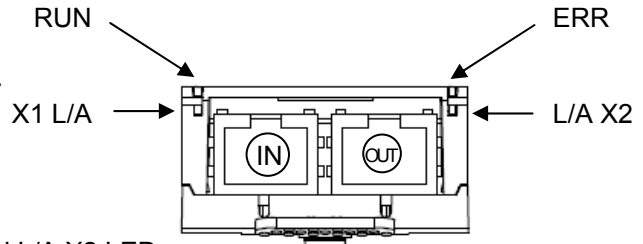

■The behavior of X1 L/A LED and L/A X2 LED

These LEDs indicate the status of the EtherCAT IN port (X1 L/A) and OUT port (L/A

X2)

Color and behavior	Meaning
OFF	No link
Green ON	Link, no activity
Green Flickering	Link, activity

■The behavior of RUN LED

It LED indicate the RUN status or RUN error

Color and behavior	Meaning
OFF	EtherCAT state: INIT
Green blinking	EtherCAT state: PRE-OPERATIONAL
Green single flashing	EtherCAT state: SAFE-OPERATIONAL
Green ON	EtherCAT state: OPERATIONAL
Red ON	Fatal error
Red Flickering	EtherCAT state: INITIALISATION or BOOTSTRAP

■The behavior of ERR LED

It LED indicate the network status or network error

Color and behavior	Meaning
OFF	No detected fault
Red ON	Fatal error
Red blinking	Invalid configuration
Red single flashing	Local error (such as synchronization error)
Red double flashing	Watchdog timeout
Red Flickering	Booting Error

#### LED Behavior Detail

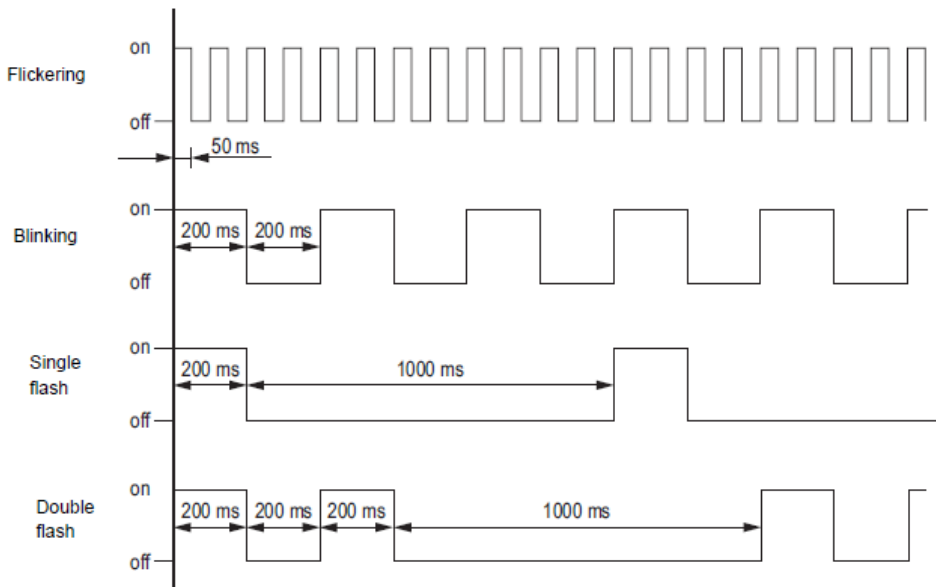

## 3. Parameters

### 3.1. Communication parameters

Set up the drive parameters as follows. It is necessary to reset the drive to update the parameter.  
This option doesn't operate if these parameters are not correctly set.

Title	Communication No.	Function	Description	Setting
<i>C003</i>	0003	Command mode selection	0: Terminal board 1: Panel keypad (including remote keypad) 2: RS485 communication 3: CANopen communication 4: Communication option	4
<i>F004</i>	0004	Frequency setting mode selection 1	0: Setting dial 1 (save even if power is off) 1: Terminal board VIA 2: Terminal board VIB 3: Setting dial 2 (press in center to save) 4: RS485 communication 5: UP/DOWN from external logic input 6: CANopen communication 7: Communication option 8: Terminal board VIC 9, 10: - 11: Pulse train input	7
<i>F856</i>	0856	Number of motor pole for communication	1: 2 poles 2: 4 poles 3: 6 poles 4: 8 poles 5: 10 poles 6: 12 poles 7: 14 poles 8: 16 poles	-
<i>F899</i>	0899	Communication function reset	0: - 1: Reset (after execution: 0)	-

### 3.2. Communication parameters for IPE003Z

Title	Communication No.	Function	Description	Default
<i>C001</i>	C001	Scanner input 1 address	0: None 1: <i>F006</i> (Communication command 1) 2: <i>F023</i> (Communication command 2) 3: <i>F007</i> (Frequency command, 0.01Hz) 5: <i>F050</i> (Terminal output data from comm.) 6: <i>F051</i> (Analog output (FM) data from comm.) 8: <i>F601</i> (Stall prevention level, %) 13: <i>ACC</i> (Acceleration time 1, 0.1s)* <sup>1</sup> 14: <i>dEC</i> (Deceleration time 1, 0.1s)* <sup>1</sup> 15: <i>UL</i> (Upper limit, 0.01Hz) 16: <i>ub</i> (Torque boost value 1, 0.1%) 17: <i>uLv</i> (Base frequency voltage 1, 0.1V) 100: CMD 101: LFRD	100* <sup>2</sup> * <sup>3</sup>
<i>C002</i>	C002	Scanner input 2 address	0-101 (Same as <i>C001</i> )	101* <sup>2</sup> * <sup>3</sup>
<i>C003</i>	C003	Scanner input 3 address	0-101 (Same as <i>C001</i> )	-
<i>C004</i>	C004	Scanner input 4 address	0-101 (Same as <i>C001</i> )	-
<i>C005</i>	C005	Scanner input 5 address	0-101 (Same as <i>C001</i> )	-
<i>C006</i>	C006	Scanner input 6 address	0-101 (Same as <i>C001</i> )	-

Title	Communication No.	Function	Description	Default
<i>C021</i>	C021	Scanner output 1 address	0: None 1: <i>Fd01</i> (Inverter status 1) 2: <i>Fd00</i> (Output frequency, 0.01Hz) 3: <i>Fd03</i> (Output current, 0.01%) 4: <i>Fd05</i> (Output voltage, 0.01%) 5: <i>Fc91</i> (Inverter alarm) 6: <i>Fd22</i> (PID feedback value, 0.01Hz) 7: <i>Fd06</i> (Input terminal status) 8: <i>Fd07</i> (Output terminal status) 9: <i>FE36</i> (VIB input, 0.01%) 10: <i>FE35</i> (VIA input, 0.01%) 11: <i>FE37</i> (VIC input, 0.01%) 12: <i>Fd04</i> (Input voltage (DC detection), 0.01%) 13: <i>Fd16</i> (Estimated speed (real-time value), 0.01Hz) 14: <i>Fd18</i> (Torque, 0.01%) 19: <i>F880</i> (Free notes) 20: <i>Fd29</i> (Input power, 0.01kW) 21: <i>Fd30</i> (Output power, 0.01kW) 22: <i>FE14</i> (Cumulative operation time, 0.01 = 1 hour) 23: <i>FE40</i> (FM terminal output monitor, 0.01%) 25: <i>Fd20</i> (Torque current, 0.01%) 26: <i>Fd23</i> (Motor overload factor, 0.01%) 27: <i>Fd24</i> (Drive overload factor, 0.01%) 28: <i>Fd25</i> (PBR overload factor, %) 29: <i>Fd26</i> (Motor load factor, %) 30: <i>Fd27</i> (Drive load factor, %) 31: <i>FE56</i> (Pulse train input, pps) 32: <i>FE70</i> (Drive rated current, 0.1A) 33: <i>FE76</i> (Input Watt-hour, kWh × 10 <sup>F749</sup> ) 34: <i>FE77</i> (Output Watt-hour, kWh × 10 <sup>F749</sup> ) 35: <i>Fd83</i> (IGBT temperature, degree C) 100: ETA 101: RFRD	100 <sup>*2*3</sup>
<i>C022</i>	C022	Scanner output 2 address	0-101 (Same as <i>C021</i> )	101 <sup>*2*3</sup>
<i>C023</i>	C023	Scanner output 3 address	0-101 (Same as <i>C021</i> )	<sup>-2*3</sup>
<i>C024</i>	C024	Scanner output 4 address	0-101 (Same as <i>C021</i> )	<sup>-2*3</sup>
<i>C025</i>	C025	Scanner output 5 address	0-101 (Same as <i>C021</i> )	<sup>-2*3</sup>
<i>C026</i>	C026	Scanner output 6 address	0-101 (Same as <i>C021</i> )	<sup>-2*3</sup>
<i>C041</i>	C041	Scanner input 1 value	The argument value set to <i>C001</i> is displayed.	<sup>-3</sup>
<i>C042</i>	C042	Scanner input 2 value	The argument value set to <i>C002</i> is displayed.	<sup>-3</sup>
<i>C043</i>	C043	Scanner input 3 value	The argument value set to <i>C003</i> is displayed.	<sup>-3</sup>
<i>C044</i>	C044	Scanner input 4 value	The argument value set to <i>C004</i> is displayed.	<sup>-3</sup>
<i>C045</i>	C045	Scanner input 5 value	The argument value set to <i>C005</i> is displayed.	<sup>-3</sup>
<i>C046</i>	C046	Scanner input 6 value	The argument value set to <i>C006</i> is displayed.	<sup>-3</sup>
<i>C061</i>	C061	Scanner output 1 value	The argument value set to <i>C021</i> is displayed.	<sup>-3</sup>
<i>C062</i>	C062	Scanner output 2 value	The argument value set to <i>C022</i> is displayed.	<sup>-3</sup>
<i>C063</i>	C063	Scanner output 3 value	The argument value set to <i>C023</i> is displayed.	<sup>-3</sup>
<i>C064</i>	C064	Scanner output 4 value	The argument value set to <i>C024</i> is displayed.	<sup>-3</sup>
<i>C065</i>	C065	Scanner output 5 value	The argument value set to <i>C025</i> is displayed.	<sup>-3</sup>
<i>C066</i>	C066	Scanner output 6 value	The argument value set to <i>C026</i> is displayed.	<sup>-3</sup>
<i>C100</i>	C100	Communication error detection delay time	0.0 - 100.0 sec.	0.1<
<i>C101</i>	C101	Inverter operation at the communication loss action	0: Stop and controlled by <i>Cn0d, Fn0d</i> 1: Operation continue 2: Deceleration stop 3: Coast stop 4: Network error stop ( <i>ErrB</i> trip) 5: Preset speed operation (by <i>C102</i> setting)	-
<i>C102</i>	C102	Preset speed operation selection	0: None 1 to 15: Preset speed	-



Title	Communication No.	Function	Description	Default
<i>C103</i>	C103	Communication time-out condition selection	0: Disconnection detection 1: When communication mode enable (Both <i>CNOd</i> and <i>FNOd</i> are set CANopen or communication option) only 2: 1 + Driving operation	0
<i>C400</i>	C400	EtherCAT slave status	1: INIT Initialization 2: PREOP Pre-operational 3: BOOTTRAP Bootstrap 4: SAFE-OP Safe operational In SAFE-OP mode, inputs are updated in PDOs, outputs are not valid. 8: OP Operational In OP mode, inputs and outputs are valid.	_* <sup>3</sup>
<i>C401</i>	C401	EtherCAT second address	0 - 65535 Address changeable from drive or from master via 2nd address dialog.	0
<i>C402</i>	C402	EtherCAT address Actual value	0 - 65535 The monitor of the EtherCAT address actual value	_* <sup>3</sup>
<i>C410</i>	C410	PDO: Command1	0x1600 subidx 0x01 Command Index No. 0x6040: Controlword	0x6040
<i>C411</i>	C411	PDO: Command2	0x1600 subidx 0x02 Command Index No. 0x6042: vl target velocity	0x6042
<i>C412</i>	C412	PDO: Command3	0x1600 subidx 0x03 Command Index No.	0
<i>C413</i>	C413	PDO: Command4	0x1600 subidx 0x04 Command Index No.	0
<i>C414</i>	C414	PDO: Command5	0x1600 subidx 0x05 Command Index No.	0
<i>C415</i>	C415	PDO: Command6	0x1600 subidx 0x06 Command Index No.	0
<i>C416</i>	C416	PDO: Monitor1	0x1A00 subidx 0x01 Monitor Index No. 0x6041: vl Statusword	0x6041
<i>C417</i>	C417	PDO: Monitor2	0x1A00 subidx 0x02 Monitor Index No. 0x6044: vl velocity actual value	0x6044
<i>C418</i>	C418	PDO: Monitor3	0x1A00 subidx 0x03 Monitor Index No.	0
<i>C419</i>	C419	PDO: Monitor4	0x1A00 subidx 0x04 Monitor Index No.	0
<i>C420</i>	C420	PDO: Monitor5	0x1A00 subidx 0x05 Monitor Index No.	0
<i>C421</i>	C421	PDO: Monitor6	0x1A00 subidx 0x06 Monitor Index No.	0

\*1: The unit depends on the *F519* setting.

\*2: These parameters are according to *C410* ~ *C421* parameters.

\*3: These parameters are "Monitor data."

Note: These default values were set when the EtherCAT option was installed.

 <b>Warning</b>	
 Mandatory action	▼ Set up "Communication error trip function ( <i>C100</i> to <i>C103</i> )" to stop the drive when EtherCAT® communication is deactivated.

### 3.3. The details of the parameter setting

#### 3.3.1. Network error detection (C 100 - C 103)

▼ Display of trip information

ErrB (Optional unit fault 1: 0x001B): Network error stop

▼ Related parameter

Title	Function	Setting range	Description
C 100	Communication error detection delay time	0.0-100.0 sec	<p>The waiting time from when a network error occurs can be adjusted. If a network error continues past the time set in C 100, it is recognized as a communication error and the operation of the drive follows the setting of C 101.</p> <p>When normal communication returns during the setting time, a communication error is not displayed and operation is continued.</p> <p>*The time unit time-out operates = EtherCAT watchdog + C 100 (communication error detection delay time) [0.1s]</p>
C 101	Inverter operation at the communications loss action	0-5	The operation of the drive when the communication fault occurs can be specified.
C 102	Preset speed operation selection	0-15	The operation frequency of the drive when the communication fault occurs can be specified. (Only when C 101 is set to 5)
C 103	Communication time-out condition selection	0-2	Select the communication time-out condition.

\*The behavior of the drive in the system that connected two (or more) drive by the EtherCAT network.

When the cable of OUT of drive at the first position is removed,  
the drive at the first position did not detect communication abnormality.  
The drive at the second position detected communication abnormality.  
The master station was able to send data (LFRD) to drive at the first position.  
However, information (ETA and RFRD) on the drive was not able to be read.

It seems that TwinCAT's problem.

## 4. Communication Object

Object Dictionary has mainly 3 profile sets.

- Communication Profile Area (Index 0x1000 to 0x1FFF)
- MB1/S15 Specific Profile Area (index 0x2000 to 0x5FFF)
- Standard Device Profile Area (Index 0x6000 to 0x9FFF)

### 4.1. Communication Profile

These objects are CANopen communication configuration settings. These communication profile object can not be mapped into PDO.

Index	Sub index	Access	Type	Default value	Description
0x1000	0x00	RO	u32	0x00410192	Device type Bits 24-31 not used (0), Bits 16-23 = Type of device (1) Bits 0-15 = Device profile number (402)
0x1001	0x00	RO	u8	0x00	Error register : Error (= 1) or no error (= 0)
0x1003*	0x00	RO	u8	0x00	Number of errors: Only one possible error (1), located in object #1003 sub 01
	0x01 to 0x10	RO	u32	(Null)	Standard error field: Bits 16-31 = Additional information (always 0) Bits 00-15 = Error code parameter
0x1008	0x00	RO	string	-	Manufacturer device name This value depends on the drive name.
0x1018	0x00	RO	u8	0x04	ID object: Number of objects
	0x01	RO	u32	0x00000284	ID object: Supplier ID 0x00000284 : Toshiba Schneider Inverter Co.
	0x02	RO	u32	0x000000E1	Product code
	0x03	RO	u32	0x00010002	Revision number
	0x04	RO	u32	-	Serial number

\*Note: Error code data are cleared of the 0x1003 object when executed the reset from power reset, terminal board, Panel Keypad, FA00 (reset command) and parameter reset ( $F899 = 1$ ).

Moreover, executed from the communication reset (CiA402 and FA06) when you want to hold the error code.

## 4.2. RPDO: Receive PDO

Index	Sub index	Access	Type	Default value	Description
0x1600	0x00	R/W	u8	0x02	Receive PDO mapping – Number of mapped object: 0 to 4 objects can be mapped for this PDO
	0x01	R/W	u32	0x60400010	Receive PDO mapping – 1st mapped object: Control word “CMD” (0x6040)
	0x02	R/W	u32	0x60420010	Receive PDO mapping – 2nd mapped object: Velocity reference “LFRD” (0x6042)
	0x03	R/W	u32	0x00000000	Receive PDO mapping: 3rd mapped object
	0x04	R/W	u32	0x00000000	Receive PDO mapping: 4th mapped object
	0x05	R/W	u32	0x00000000	Receive PDO mapping: 5th mapped object
	0x06	R/W	u32	0x00000000	Receive PDO mapping: 6th mapped object

## 4.3. TPDO: Transmit PDO

Index	Sub index	Access	Type	Default value	Description
0x1A00	0x00	R/W	u8	0x02	Transmit PDO mapping: Number of mapped objects.
	0x01	R/W	u32	0x60410010	Transmit PDO mapping – 1st mapped object: Status word “ETA” (0x6041)
	0x02	R/W	u32	0x60440010	Transmit PDO mapping – 2nd mapped object: Velocity reference “RFRD” (0x6044/00) default value
	0x03	R/W	u32	0x00000000	Transmit PDO mapping: 3rd mapped object
	0x04	R/W	u32	0x00000000	Transmit PDO mapping: 4th mapped object
	0x05	R/W	u32	0x00000000	Transmit PDO mapping: 5th mapped object
	0x06	R/W	u32	0x00000000	Transmit PDO mapping: 6th mapped object

## 4.4. MB1/S15 specific profile

Drive parameters are defined as Manufacturer Specific Objects.

Drive parameter F\*\*\* are defined as 0x2\*\*\*\*. So drive parameters from F000 to FFFF are accessed from network as Objects.

The MB1/S15 parameters are based on CANopen addresses.

Parameter No.	Comm. No.	Object No.	Trans. type	Note
F000 ~ F999	0000 ~ 0999	0x2000 ~ 0x2999	SDO PDO*	User parameter area
FA00 ~ FF99	FA00 ~ FF99	0x2A00 ~ 0x2F99	SDO PDO*	Disclosed command and monitor parameter No. can be mapped. Refer to the communication manual.
A000 ~ AF99	A000 ~ AF99	0x3000 ~ 0x3F99	SDO	User parameter area
C000 ~ CF99	C000 ~ CF99	0x4000 ~ 0x4F99	SDO	User parameter area

\*C001-C006 and C021-C026 supported parameters are able to mapping to PDO.

## 4.5. Application Profile (CiA402)

These are contains standardized parameters in conformance with CiA402 velocity mode.

Index	Sub index	Access	Type	PDO Mapping	Default value	Description
0x603F	0x00	RO	u16	No	0x0000	Error code
0x6040	0x00	R/W	u16	Yes	0x0000	Control Word
0x6041	0x00	RO	u16	Yes	0x0000	Status word
0x6042	0x00	R/W	i16	Yes	0x0000	VI_Target_Velocity (min <sup>-1</sup> )
0x6043	0x00	RO	i16	No	0x0000	VI_Velocity_Demand (min <sup>-1</sup> )
0x6044	0x00	RO	i16	Yes	0x0000	VI_Velocity_Actual_Value (min <sup>-1</sup> )
0x6046	0x00	RO	u8	No	0x02	VI Velocity Min Max Amount
	0x01	R/W	u32	No	0x0000 0000	VI_Velocity_Min_Amount (min <sup>-1</sup> )
	0x02	R/W	u32	No	0x0000 05DC	VI_Velocity_Max_Amount (min <sup>-1</sup> )
0x6048	0x00	RO	u8	No	0x02	VI Velocity Acceleration: Highest sub-index supported
	0x01	R/W	u32	No	0x0000 05DC	VI_Velocity_Acceleration Delta_Speed (min <sup>-1</sup> )
	0x02	R/W	u16	No	0x000A	VI_Velocity_Acceleration Delta_Time (s)
0x6049	0x00	RO	u8	No	0x02	VI Velocity Deceleration: Highest sub-index supported
	0x01	R/W	u32	No	0x0000 05DC	VI_Velocity_Deceleration Delta_Speed (min-1)
	0x02	R/W	u16	No	0x000A	VI_Velocity_Deceleration Delta_Time (s)
0x604A	0x00	RO	u8	No	0x02	VI Velocity Quick Stop: Highest sub-index supported
	0x01	R/W	u32	No	0x0000 05DC	VI_Velocity_Quick_Stop Delta_Speed (min-1)
	0x02	R/W	u16	No	0x0006	VI_Velocity_Quick_Stop Delta_Time (s)
0x605A	0x00	R/W	i16	No	0x0002	Quick Stop Option Code
0x6502	0x00	RO	u32	No	0x0000 0002	Supported drive mode
0x6060	0x00	R/W	i8	No	0x02	Mode of operation
0x6061	0x00	RO	i8	No	0x02	Mode of operation display



## 4.6. Abort code (CiA 301)

The abort code in the below table are set in the error response data.

Abort Code	Contents
0503 0000	Toggle bit not alternated.
0504 0000	SDO protocol timed out.
0504 0001	Client/server command specifier not valid or unknown.
0504 0002	Invalid block size (block mode only).
0504 0003	Invalid sequence number (block mode only).
0504 0004	CRC error (block mode only).
0504 0005	Out of memory.
0601 0000	Unsupported access to an object.
0601 0001	Attempt to read a write only object.
0601 0002	Attempt to write a read only object.
0602 0000	Object does not exist in the object dictionary.
0604 0041	Object cannot be mapped to the PDO.
0604 0042	The number and length of the objects to be mapped would exceed PDO length.
0604 0043	General parameter incompatibility reason.
0604 0047	General internal incompatibility in the device.
0606 0000	Access failed due to an hardware error.
0607 0010	Data type does not match, length of service parameter does not match
0607 0012	Data type does not match, length of service parameter too high
0607 0013	Data type does not match, length of service parameter too low
0609 0011	Sub-index does not exist.
0609 0030	Invalid value for parameter (download only).
0609 0031	Value of parameter written too high (download only).
0609 0032	Value of parameter written too low (download only).
0609 0036	Maximum value is less than minimum value.
060A 0023	Resource not available: SDO connection
0800 0000	General error
0800 0020	Data cannot be transferred or stored to the application.
0800 0021	Data cannot be transferred or stored to the application because of local control.
0800 0022	Data cannot be transferred or stored to the application because of the present device state.
0800 0023	Object dictionary dynamic generation fails or no object dictionary is present (e.g. object dictionary is generated from file and generation fails because of a file error).
0800 0024	No data available

---

## 5. Drive profile

---

IPE003Z has two drive profile modes, CiA 402 Drive profile mode and TOSHIBA drive profile mode.

---

### 5.1. CiA 402 Drive profile

---

Using CiA 402 Drive profile, form EtherCAT network, the drive can be controlled.

When using the drive profile command, please set the command mode selection to communication option (*CMD=4*), Frequency setting mode selection 1 to communication option (*FMD=7*) and Number of motor poles for communication (*PSS*) parameters.

And set the RPDO mappings (0x6040) and (0x6042).

\*Do not select the following parameters about RPDO mappings when using CiA 402 Drive profile.

- FA06, FA07,FA23

---

### 5.2. TOSHIBA Drive profile

---

Using TOSHIBA Drive profile, form EtherCAT network, the drive can be controlled.

TOSHIBA Drive profile is operated when conditions are not right in CiA 402 Drive profile.

5.2.1.1. *FAD6* (Communication command1)

bit	Function	0	1	Note
0	Preset speed operation frequencies 1	Preset speed operation is disabled or preset speed operation frequencies (1-15) are set by specifying bits for preset speed operation frequencies 1-4. (0000: Preset speed operation OFF, 001-1111: Setting of preset speed operation frequencies (1-15))		
1	Preset speed operation frequencies 2			
2	Preset speed operation frequencies 3			
3	Preset speed operation frequencies 4			
4	Motor selection (1 or 2) (THR 2 selection)	Motor 1 (THR 1)	Motor 2 (THR 2)	THR 1: $Pt = \text{setting value}, tHr$ THR 2: $Pt = 0, F170, F171, F172, F173$
5	PI D control	Normal operation	PI D off	-
6	Acceleration/deceleration pattern selection (1 or 2) (AD2 selection)	Acceleration/deceleration pattern 1 (AD1)	Acceleration/deceleration pattern 2 (AD2)	AD1: $ACC, DEC$ AD2: $F500, F501$
7	DC braking	OFF	Forced DC braking	-
8	Jog run	OFF	Jog run	-
9	Forward/reverse run selection	Forward run	Reverse run	-
10	Run/stop	Stop	Run	-
11	Coast stop command	Standby	Coast stop	-
12	Emergency stop	OFF	Emergency stop	Always enable, "E" trip
13	Fault reset	OFF	Reset	No data is returned from the drive
14	Frequency priority selection	OFF	Enabled	Enabled regardless of the setting of $FADd$
15	Command priority selection	OFF	Enabled	Enabled regardless of the setting of $CADd$

\* VF-S15: When 14( $SR0$ ) is set to  $FADd$ , preset speed operation frequency 0 is selected.

5.2.1.2. *FA23* (Communication command 2)

bit	Function	0	1	Note
0	(Reserved)	-	-	-
1	Electric power quantity reset	OFF	Reset	Electric power quantity ( <i>FE76</i> , <i>FE77</i> ) reset
2	(Reserved)	-	-	-
3	(Reserved)	-	-	-
4	(Reserved)	-	-	-
5	(Reserved)	-	-	-
6	(Reserved)	-	-	-
7	Maximum deceleration forced stop	Normal	Enabled	-
8	Acceleration/deceleration selection 1	00: Acceleration/deceleration 1 01: Acceleration/deceleration 2 10: Acceleration/deceleration 3		Select acceleration/deceleration 1-4 by combination of two bits.. AD1: <i>ACC</i> , <i>DEC</i> AD2: <i>F500</i> , <i>F501</i> AD3: <i>F510</i> , <i>F511</i>
9	Acceleration/deceleration selection 2			
10	(Reserved)	-	-	-
11	(Reserved)	-	-	-
12	OC stall level switch	OC stall 1	OC stall 2	OC stall 1: <i>F601</i> OC stall 2: <i>F185</i>
13	(Reserved)	-	-	-
14	(Reserved)	-	-	-
15	(Reserved)	-	-	-

Note: Set 0 to reserved bit.

### 5.2.1.3. *F A 0 7* (frequency reference from internal option)

---

Frequency reference is set up by 0.01Hz unit and the hexadecimal number.

For example, when "Frequency reference" is set up to 80Hz, since the minimum unit is 0.01Hz,  
 $80 / 0.01 = 8000 = 0x1F40$  (Hex.)

### 5.2.1.4. *F A 5 0* (Terminal output data from communication)

---

By setting up the data of the bit 0 - 1 of terminal output data (*F A 5 0*) from communication, setting data (OFF or ON) can be outputted to the output terminal.

Please select the functional number 92 - 95 as the selection (*F 1 3 0* - *F 1 3 8*) of the output terminal function before using it.

bit	Output TB function name	0	1
0	Specified data output 1 (Output terminal No.: 92, 93)	OFF	ON
1	Specified data output 2 (Output terminal No.: 94, 95)	OFF	ON
2-15	(Reserved)	-	-

Note: Set 0 to reserved bit

### 5.2.1.5. *F A 5 1* (Analog output (FM) data from communication)

---

Use this function, set the FM terminal meter selection parameter (*F A 5 1*) to 18 (communication data output).

This makes it possible to send out the data specified as FM analog output data (*F A 5 1*) though the FM analog output terminal. Data can be adjusted in a range of 0 to 1000 (resolution of 10 bit).

Please refer to "Meter setting and adjustment" Section of the VF-MB1/S15 instruction manual for details.

**5.2.1.6. *Fd01* (Inverter operating status 1 (real time))**

bit	Function	0	1	Note
0	Failure FL	No output	Under in progress	-
1	Failure	Not tripped	Tripped	Trip status includes <i>rtry</i> and the trip retention status are also regarded as tripped statuses.
2	Alarm	No alarm	Alarm issued	-
3	Under voltage ( <i>NOFF</i> )	Normal	Under voltage	-
4	Motor selection (1 or 2) (THR 2 selection)	Motor 1 (THR1)	Motor 2 (THR2)	THR1: <i>Pt</i> = setting value, <i>uL</i> , <i>uLu</i> , <i>ub</i> , <i>tHr</i> THR2: <i>Pt</i> = 0, <i>F170</i> , <i>F171</i> , <i>F172</i> , <i>F173</i>
5	PID control off	PID control permitted	PID control prohibits	-
6	Acceleration/deceleration pattern selection (1 or 2)	Acceleration/deceleration pattern 1 (AD1)	Acceleration/deceleration pattern 2 (AD2)	AD1: <i>ACC</i> , <i>DEC</i> AD2: <i>F500</i> , <i>F501</i>
7	DC braking	OFF	Forced DC braking	-
8	Jog run	OFF	Jog run	-
9	Forward / reverse run	Forward run	Reverse run	-
10	Run/stop	Stop	Run	-
11	Coast stop (ST = OFF)	ST=ON	ST=OFF	-
12	Emergency stop	No emergency stop status	Emergency stop status	-
13	Standby ST=ON	Start-up process	Standby	Standby: Initialization completed, not failure stop status, not alarm stop status ( <i>NOFF</i> , <i>LL</i> forced stop), ST=ON, and RUN=ON
14	Standby	Start-up process	Standby	Standby: Initialization completed, not failure stop status and not alarm stop status ( <i>NOFF</i> , <i>LL</i> forced stop)
15	(Undefined)	-	-	-

Note: The bit described "Undefined" is unstable. Don't use the bit for the judgment.

**5.2.1.7. *Fd00* (Output frequency (real time))**

The current output frequency is read into 0.01Hz of units and by the hexadecimal number. For example, when the output frequency is 80Hz, 0x1F40 (hexadecimal number) are read.

Since the minimum unit is 0.01%,  
 $0x1F40 \text{ (Hex.)} = 8000 \text{ (Dec.)} * 0.01 = 80 \text{ (Hz)}$

Also about the following parameters, these are the same as this.

- *Fd22* (Feedback value of PID (real time)) ..... Unit: 0.01Hz
- *Fd16* (Estimated speed (real time)) ..... Unit: 0.01Hz
- *Fd29* (Input power (real time)) ..... Unit: 0.01kW
- *Fd30* (Output power (real time)) ..... Unit: 0.01kW

### 5.2.1.8. *F d 0 3* (Output current (real time))

---

The output current is read into 0.01% of units and by the hexadecimal number.

For example, when the output current of the rated current 4.8A drive is 50% (2.4A), 0x1388 (hexadecimal number) is read out.

Since the minimum unit is 0.01%,

$$0x1388 \text{ (Hex.)} = 5000 \text{ (Dec.)} * 0.01 = 50 \text{ (\%)}$$

Also about the following parameters, these are the same as this.

- *F d 0 5* (Output voltage (real time))..... Unit: 0.01% (V)
- *F d 0 4* (Voltage at DC bus (real time))..... Unit: 0.01% (V)
- *F d 1 8* (Torque) ..... Unit: 0.01% (Nm)\*

\* When the motor information connected to the drive set to the parameter (*F 4 0 5* - *F 4 1 5*), torque monitor value "100%" is same as the rated torque of a motor in general.

### 5.2.1.9. *F E 3 5, F E 3 6, F E 3 7* (Monitoring of the analog input VIA, VIB, VIC)

---

VIA terminal board monitor: "Communication Number *F E 3 5*"

VIB terminal board monitor: "Communication Number *F E 3 6*"

VIC terminal board monitor: "Communication Number *F E 3 7*"

These monitors can also be used as A/D converters irrespective of the drive's control.

VIA / VIC terminal board monitor is capable of reading the data from external devices in a range of 0.01 to 100.00% (unsigned data: 0x0000 to 0x2710).

VIB terminal board monitor is capable of reading the data from external devices in a range of -100.00 to 100.00% (signed data: 0xD8F0 to 0x2710).

If analog input mode is selected with the frequency setting mode selection parameter, however, keep in mind that any data entered via an analog terminal is regarded as a frequency command.

### 5.2.1.10. *F E 1 4* (Cumulative run time)

---

The operated cumulative time is read by the hexadecimal number.

For example, when cumulative operation time is 18 hours, 0x12 (18 hours) is read.

$$0x12 \text{ (Hex.)} = 18 \text{ (Dec., hour)}$$

### 5.2.1.11. *F E 4 0* (Analog output (FM))

---

The output value of FM terminal is read.

The value range is set to 0 to 10000 (0x2710).

**5.2.1.12. F C 9 1 (Alarm code)**

bit	Function	0	1	Remarks (Code displayed on the panel)
0	Over-current alarm	Normal	Alarming	$\overline{L}$ flicking
1	Inverter over load alarm	Normal	Alarming	$\overline{L}$ flicking
2	Motor over load alarm	Normal	Alarming	$\overline{L}$ flicking
3	Over heat alarm	Normal	Alarming	$\overline{H}$ flicking
4	Over voltage alarm	Normal	Alarming	$\overline{P}$ flicking
5	Main circuit undervoltage alarm	Normal	Alarming	-
6	main device overheat alarm	Normal	Alarming	$\overline{L}$ flicking
7	Under current alarm	Normal	Alarming	-
8	Over-torque alarm	Normal	Alarming	-
9	Braking resistor overload alarm	Normal	Alarming	-
10	Cumulative operation hours alarm	Normal	Alarming	-
11	Option communication alarm	Normal	Alarming	-
12	Serial communication alarm	Normal	Alarming	-
13	MOFFMS (MSrelay off or MOFF)	Normal	Alarming	-
14	Stop after instantaneous power off	-	Dec., Under stop	Refer to $F 3 0 2$ value
15	Stop after LL continuance time	-	Dec., Under stop	Refer to $F 2 5 5$ value

**5.2.1.13. F d 0 6 (Input TB Status)**

bit	TB Name	Function (Parameter)	0	1
0	F	Input terminal function selection 1 ( $F 1 1 1$ )	OFF	ON
1	R	Input terminal function selection 2 ( $F 1 1 2$ )		
2	RES	Input terminal function selection 3 ( $F 1 1 3$ )		
3	S1	Input terminal function selection 4 ( $F 1 1 4$ )		
4	S2	Input terminal function selection 5 ( $F 1 1 5$ )		
5	S3	Input terminal function selection 6 ( $F 1 1 6$ )		
6	VIB*1	Input terminal function selection 7 ( $F 1 1 7$ )		
7	VIA*1	Input terminal function selection 8 ( $F 1 1 8$ )		
5 to 15	(Undefined)	-	-	-

Note: The bit described "Undefined" is unstable. Do not use the bit for the judgment.

\*1: VIA/ VIB are input terminal function when  $F 1 0 9$  is logic input.

\*The input terminal function is selected by each parameter.

**5.2.1.14. F d 0 7 (Output TB Status)**

bit	TB Name	Function (Parameter)	0	1
0	RY-RC	Output terminal function selection 1A ( $F 1 3 0$ )	OFF	ON
1	OUT	Output TB Function select 2A ( $F 1 3 1$ )	OFF	ON
2	FL	Output TB Function select 3 ( $F 1 3 2$ )	OFF	ON
3 - 15	(Undefined)	-	-	-

Note: The bit described "Undefined" is unstable. Do not use the bit for the judgment.



## 6. CiA<sup>®</sup> 402 – IEC61800-7 Functional Profile

### Functional description:

Drive operation involves two main functions, which are illustrated in the diagrams below:

### 6.1. Velocity mode object

#### 6.1.1. CiA 402 profile

The main parameters are shown with their CiA402 name and their CiA402/Drivecom index (the values in brackets are the CANopen addresses of the parameter).

#### Control diagram:

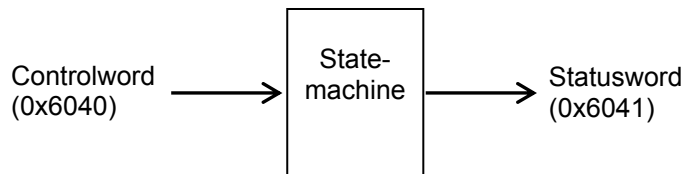

#### Simplified diagram of speed control in “Velocity” mode:

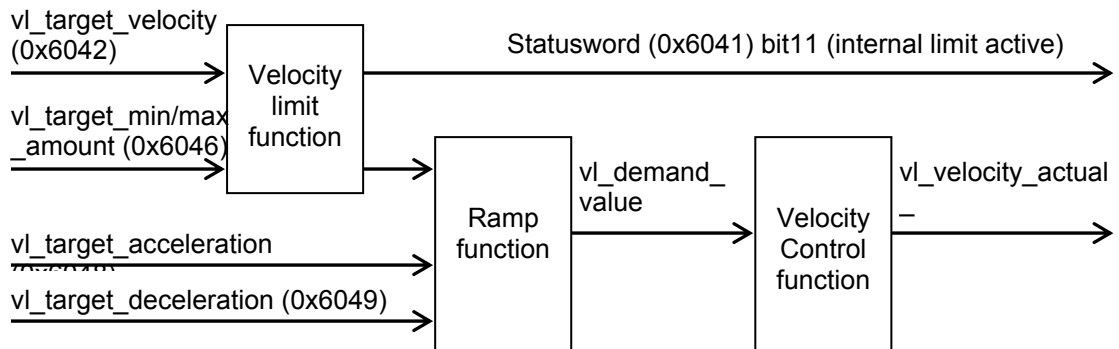

6.1.2. TOSHIBA drive profile

These diagrams translate as follows for the MB1/S15 system:

Control diagram:

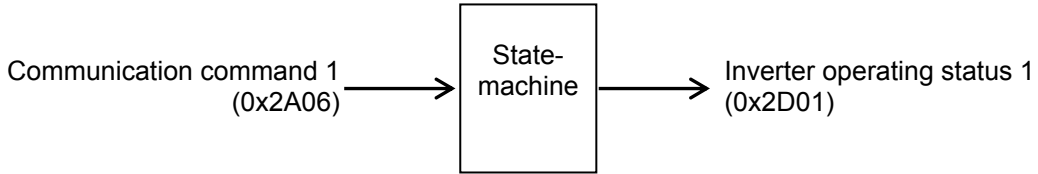

Simplified diagram of speed control in “Velocity” mode:

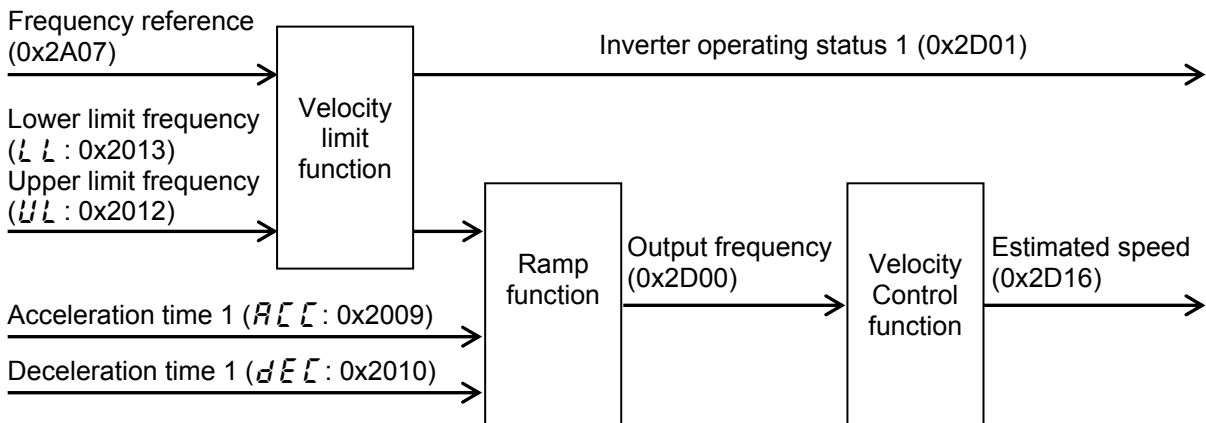

**6.1.3. Object 0x6040: Controlword**

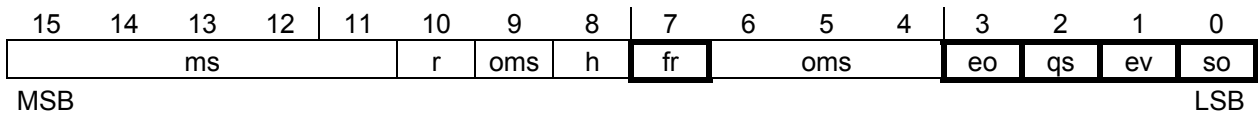

ms = manufacturer-specific  
 (bit11: 0 = Forward direction asked, 1 = Reverse direction asked);  
 r = reserved;  
 oms = operation mode specific;  
 h = halt;  
 fr = fault reset;  
 eo = enable operation;  
 qs = quick stop;  
 ev = enable voltage;  
 so = switch on

**6.1.4. Object 6041: Statusword**

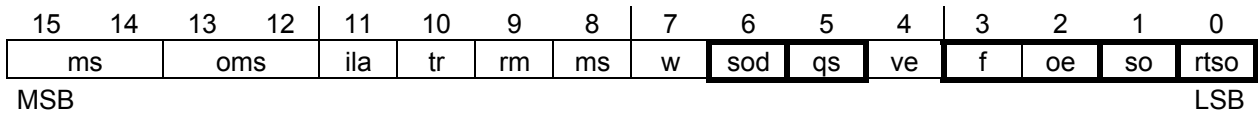

ms = manufacturer-specific;  
 oms = operation mode specific;  
 ila = internal limit active;  
 rm = remote;  
 w = warning;  
 sod = switch on disabled;  
 qs = quick stop;  
 ve = voltage enabled;  
 f = fault;  
 oe = operation enabled;  
 so = switched on;  
 rtso = ready to switch on

Status	bit 6	bit 5	bit 4	bit 3	bit 2	bit 1	bit 0	Status Word
	Switch on disabled	Quick stop	Voltage enabled	Fault	Operation enabled	Switched on	Ready to switch on	
1 - Not ready to switch on	0	×	×	0	0	0	0	-
2 - Switch on disabled	1	×	×	0	0	0	0	0x0040
3 - Ready to switch on	0	1	×	0	0	0	1	0x0021
4 - Switched on	0	1	1	0	0	1	1	0x0033
5 - Operation enabled	0	1	1	0	1	1	1	0x0037

Status	bit 6	bit 5	bit 4	bit 3	bit 2	bit 1	bit 0	Status Word
	Switch on disabled	Quick stop	Voltage enabled	Fault	Operation enabled	Switched on	Ready to switch on	
6 - Quick stop active	0	0	1	0	1	1	1	0x0017
7 - Fault reaction active	0	×	×	1	1	1	1	-
8 - Fault	0	×	×	1	0	0	0	*0x0008 or 0x0028

×: In this state, the value of the bit can be 0 or 1.

\*Detected fault following state "6 - Quick stop active".

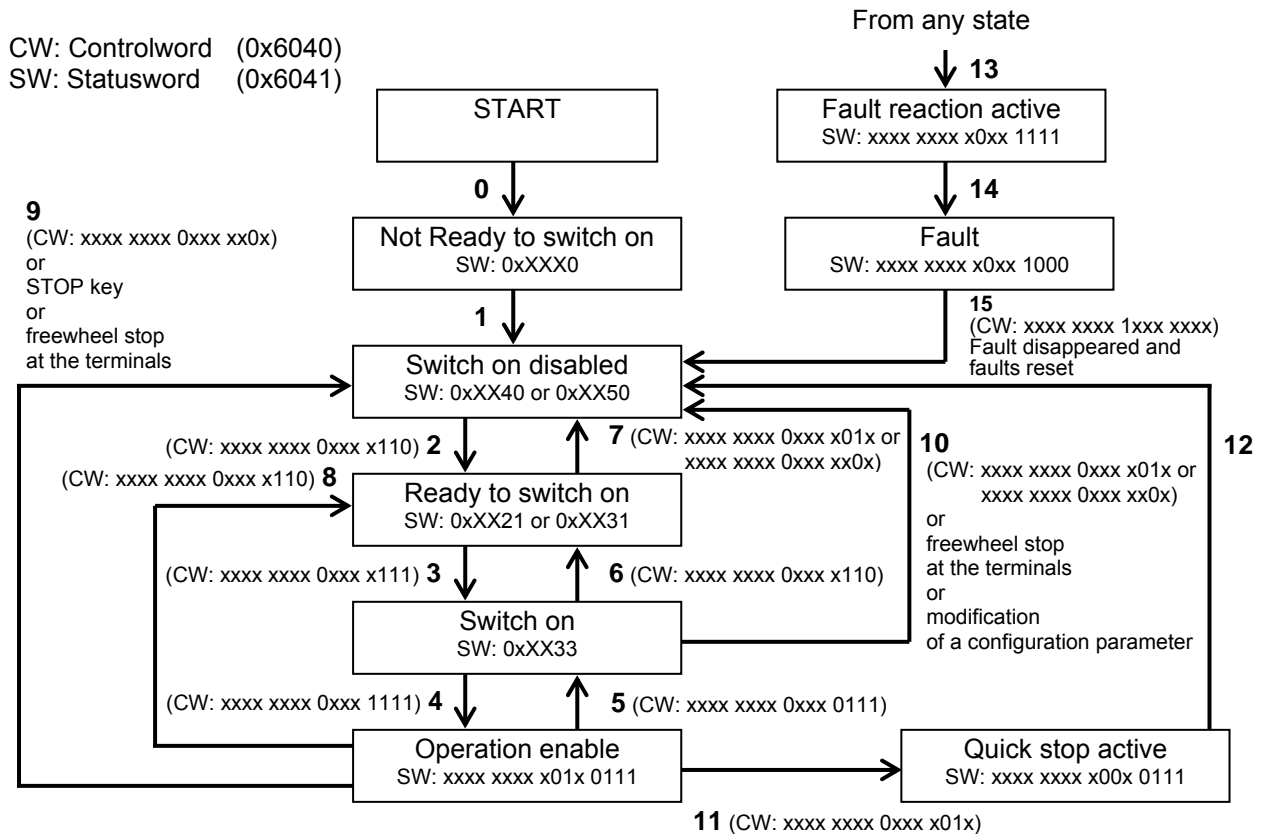

Command coding (CiA DS402-2 DSP BV3.0 Table 27)

Command	Bits of the Controlword					Transitions
	fault reset	enable operation	Quick stop	enable voltage	switch on	
	Bit 7	Bit 3	Bit 2	Bit 1	Bit 0	
Shutdown	x	x	1	1	0	2, 6, 8
Switch on	x	x	1	1	1	3
Enable operation	x	1	1	1	1	4
Disable voltage	x	x	x	0	x	7, 9, 10
Quick stop	x	x	0	1	x	7, 10, 11
Disable operation	x	0	1	1	1	5
Fault reset	↑	x	x	x	x	15

x: Value is of no significance for this command.

### 6.1.5. CiA402 State Chart

#### Description of States

Each state represents an internal reaction by the drive.

This chart will change depending on whether the control word is sent "CMD" or an event occurs (a detected fault, for example).

The drive state can be identified by the value of the status word "ETA."

State	Drive internal reaction
1- Not Ready to switch on	Initialization stats. This is a transient state invisible to the communication network.
2 - Switch on disable	The drive is inactive. The drive is locked, no power is supplied to the motor.
3 – Ready to switched on	The drive is supplied with AC power but is stationary. The drive is locked, no power is supplied to the motor.
4 - Switched on	The drive is supplied with AC power but is stationary. The drive is locked, no power is supplied to the motor. The power stage of the drive is ready to operate, but voltage has not yet been applied to the output.
5 - Operation enabled	The drive is running. The drive is unlocked, power is supplied to the motor. The drive functions are activated and voltage is applied to the motor terminals. If the reference is zero or the "Halt" command is applied, no power is supplied to the motor and no torque is applied. "ATN" Auto tuning requires an injection of current into the motor. The drive must therefore be in state "5 - Operation enabled" for this command. NOTE: The command "4 - Enable operation" must be taken into consideration only if the channel is valid. In particular, if the channel is involved in the command and the reference, transition 4 will take place only after the reference has been received for the first time.
6 - Quick stop active	Emergency stop. The drive performs a fast stop, after which restarting will only be possible once the drive has changed to the "Switch on disabled" state. During fast stop, the drive is unlocked and power is supplied to the motor. The condition for transition 12 to state "2 - Switch on disabled" depends on the value of the parameter "Quick stop mode": If the "Quick stop mode" parameter has the value 0, the drive stops freewheel and then changes to state "2 - Switch on disabled". If the "Quick stop mode" parameter has the value 1, the drive stops according to the slow down ramp and then changes to state "2 - Switch on disabled". If the "Quick stop mode" parameter has the value 2, the drive stops according to the quick stop ramp (0x604A) and the changes to state "2 - Switch on disabled". Do not set the value 3 to "Quick stop parameter". If the "Quick stop mode" parameter has the value 4, the drive stops according to the voltage limit and the changes to state "2 - Switch on disabled".

State	Drive internal reaction
7 - Fault reaction active	Transient state during which the drive performs an action appropriate to the type of detected fault. The drive function is activated or deactivated according to parameter <i>F603</i> when detected the emergency stop.
8 - Fault	Drive has detected a fault. The drive is locked, no power is supplied to the motor.

Summary

State	Power supplied to motor
1 - Not ready to switch on	No
2 - Switch on disabled	No
3 - Ready to switch on	No
4 - Switched on	No
5 - Operation enabled	Yes
6 - Quick stop active	Yes, during fast stop
7 - Fault reaction active	Depends on parameter <i>F603</i> when detected the emergency stop.
8 - Fault	No

### 6.1.6. Object 0x6042: vl\_target\_velocity

This object shall indicate the required velocity of the system. The value is given in revolutions per minute ( $\text{min}^{-1}$ ). Positive values forward direction and negative values indicate reverse direction.

At changing to “Operation enable” state, this target velocity is cleared. So set this target velocity data after changed the state to “Operation enable.”

#### **Warning**



▼ This object value is depending on the *F855* parameter and confirms it setting value. The motor rotational speed of the forecast is not obtained when the setting is mistaken, and there is danger of causing the accident etc.

### 6.1.7. Object 0x6043: vl\_velocity\_demand

This object provides the instantaneous velocity generated by the ramp function. It is an internal object of the drive device. The value is given same unit as the vl\_target\_velocity. Positive values indicate forward direction and negative values indicates direction.

### 6.1.8. Object 0x6044: vl\_velocity\_actual\_value

This object provides the velocity at the motor spindle or load. Depending on the implementation (simple drive device, without sensor, etc.), the drive provides the appropriate image of the actual velocity (velocity demand, velocity control effort, calculated velocity).

The value is given in the same unit as the vl\_target\_velocity. A positive value indicates forward direction and negative values indicates reverse direction.

### 6.1.9. Object 0x6046: vl\_velocity\_min\_max\_amount

This object indicates the configured minimum and maximum amount of velocity (unit  $\text{min}^{-1}$ ). The vl\_velocity\_max amount sub-object is mapped internally to the vl\_velocity\_max positive and vl\_velocity\_max negative values. The vl\_velocity\_min positive and vl\_velocity\_min negative values.

At initial configuration, the Upper limit frequency ( $f_{UL}$ ) and Lower limit frequency ( $f_{LL}$ ) of the drive may be not same value with Object 0x6046 setting value. And when changes the upper limit frequency and the lower limit frequency of the drive parameter, Object 6046 value is different with the drive parameters. To correspond these limit value, set Object 6046.

### 6.1.10. Object 0x6048: vl\_velocity\_acceleration

This object indicates the configured delta speed and delta time of the slope of the acceleration ramp.

Velocity Acceleration Delta Speed : 225 to 30,000 min<sup>-1</sup>

Velocity Acceleration Delta Time : 0.1 to 3,600 s

Note: Do not change the acceleration/deceleration time unit (parameter *F519*), if change the parameter, the setting value range will be different from above range.

### 6.1.11. Object 0x6049: vl\_velocity\_deceleration

This object indicates the configured delta speed and delta time of the slope of the deceleration ramp.

Velocity Deceleration Delta Speed : 225 to 30,000 min<sup>-1</sup>

Velocity Deceleration Delta Time : 0.1 to 3,600 s

Note: Do not change the acceleration/deceleration time unit (parameter *F519*), if change the parameter, the setting value range will be different from above range.

### 6.1.12. Object 0x604A: vl\_velocity\_quick\_stop

This object indicates the configured delta speed and delta time of the slope of the deceleration ramp for quick stop.

Velocity Deceleration Delta Speed : 225 to 30,000 min<sup>-1</sup>

Velocity Deceleration Delta Time : 0.1 to 3,600 s

Note: Do not change the acceleration/deceleration time unit (parameter *F519*), if change the parameter, the setting value range will be different from above range.

### 6.1.13. Object 0x605A: Quick stop option code

This object shall indicate what action is performed when the quick stop function is executed.

The slow down ramp is the deceleration value of the used mode of operations.

Value	Definition
-32768 to -1	No function
0	Disable drive function
+1	Slow down on slow down ramp and transit into Switch On Disabled
+2	Slow down on quick stop ramp and transit into Switch On Disabled
+3	Do not set
+4	Slow down on voltage limit and transit into Switch On Disabled
+5*	Slow down on slow down ramp and stay in Quick Stop Active
+6*	Slow down on quick stop ramp and stay in Quick Stop Active
+7*	Do not set
+8*	Slow down on voltage limit and stay in Quick Stop Active
+9 to +32 767	Reserved

\*Not supported these values. Do not set these values. If set the value 5-8, the drive slow down ramp and transit into Switch On Disabled.



### 6.1.14. Object 0x6060: Mode of operation

The object shall indicate the requested operation mode.  
This module supports the “vl (= 2)” (velocity mode) only.

NOTE: This object shows only the value of the requested operation mode, the actual operation mode of the PDS\* is reflected in the object modes of operation display.

\*PDS: Power drive system

Value	Definition
-128 to -1	Manufacturer-specific operation modes
0	No mode change/no mode assigned
+1	Profile position mode
<b>+2</b>	<b>Velocity mode</b>
+3	Profile velocity mode
+4	Torque profile mode
+5	Reserved
+6	Homing mode
+7	Interpolated position mode
+8	Cyclic sync position mode
+9	Cyclic sync velocity mode
+10	Cyclic sync torque mode
+11 to +127	Reserved

### 6.1.15. Object 0x6061: Mode of operation display

This object shall provide the actual operation mode.  
This module supports the “vl (= 2)” (velocity mode) only.

### 6.1.16. Object 0x6502: Supported drive mode

This object shall provide information on the supported drive modes.  
This module supports the “vl (= 2)” (velocity mode) only.

31	...	16	15	...	10	9	8	7	6	5	4	3	2	1	0
Manufacturer-specific		r(reserved)			cst	csv	csp	ip	hm	r	tq	pv	<b>vl</b>	pp	
MSB														LSB	

## 6.2. Object 603F: Error Code

Below table describes the relations of the error code and drive error.

Error code	Meaning	Drive trip code	Drive error name	Drive condition
0x0000	No error	0x00	---	---
0x1000	Generic error	0x0E	<i>DL2</i>	Motor overload
		0x15	<i>Err2</i>	Main unit RAM fault
		0x16	<i>Err3</i>	Main unit ROM fault
		0x17	<i>Err4</i>	CPU fault 1
		0x1A	<i>Err7</i>	Current detector fault
		0x1C	<i>Err9</i>	Remote keypad disconnection fault
		0x28	<i>Et n</i>	Auto-tuning error
		0x35	<i>E-21</i>	CPU fault 2
		0x3A	<i>E-26</i>	CPU fault 3
		0x54	<i>Et n 1</i>	Auto-tuning error
0x55	<i>Et n 2</i>	Auto-tuning error		
0x56	<i>Et n 3</i>	Auto-tuning error		
0x2230	Short circuit/earth leakage (device internal)	0x05	<i>OC A</i>	Overcurrent at start-up
0x2310	Continuous over current	0x01	<i>OC 1</i>	Overcurrent during acceleration
		0x02	<i>OC 2</i>	Overcurrent during deceleration
		0x03	<i>OC 3</i>	Overcurrent during constant speed operation
0x2311	Continuous over-current No. 1	0x20	<i>OL</i>	Over-torque trip 1
		0x41	<i>OL2</i>	Over-torque trip 2
		0x48	<i>OLC3</i>	Over-torque / Overcurrent fault
0x2320	Short circuit/earth leakage (motor-side)	0x04	<i>OCL</i>	Overcurrent (An overcurrent on the load side at start-up)
0x2330	Earth leakage	0x22	<i>EF2</i>	Ground fault
0x3110	Mains over-voltage	0x0A	<i>OP1</i>	Overvoltage during acceleration
		0x0B	<i>OP2</i>	Overvoltage during deceleration
		0x0C	<i>OP3</i>	Overvoltage during constant speed operation
0x3120	Mains under-voltage	0x1E	<i>UP1</i>	Undervoltage fault (main circuit)
0x3130	Phase failure	0x08	<i>EPH1</i>	Ground fault
0x3310	Output over-voltage	0x09	<i>EPHO</i>	Output phase failure
		0x0F	<i>DLr</i>	Dynamic braking resistor overload trip
		0x47	<i>E-39</i>	Auto-tuning error (PM motor)
0x4210	Excess temperature device	0x0D	<i>OL1</i>	Inverter overload
		0x10	<i>OH</i>	Overheat
		0x3E	<i>OL3</i>	Main module overload
0x5530	Control EEPROM failure	0x12	<i>EEP1</i>	EEPROM fault 1
		0x13	<i>EEP2</i>	EEPROM fault 2
		0x14	<i>EEP3</i>	EEPROM fault 3
		0x29	<i>EtYP</i>	Inverter type error
0x6100	Internal software	0x33	<i>E-19</i>	CPU communication error
		0x37	<i>E-23</i>	Optional unit fault 2
0x7300	Sensor	0x2E	<i>OH2</i>	Thermal fault stop command from external device
		0x32	<i>E-18</i>	Analog input break detection fault
		0x40	<i>E-32</i>	PTC fault
0x7310	Speed	0x2D	<i>E-13</i>	Over speed fault
0x7510	Serial interface No. 1	0x18	<i>Err5</i>	Communication error
0x7520	Serial interface No. 2	0x1B	<i>Err8</i>	Optional unit fault 1
0x8331	Torque fault	0x2F	<i>SOUL</i>	Step-out (for PM motor drive only)
		0x34	<i>E-20</i>	Over torque boost fault
0x8501	Servo lock failure	0x45	<i>E-37</i>	Servo lock fault
0x9000	External malfunction	0x11	<i>E</i>	Emergency stop
0xFF00	Additional functions - generic error	0x54	<i>Et n 1</i>	Auto-tuning error
0xFF03	Device specific - generic error	0x1D	<i>UL</i>	Low-current operation fault
		0x3B	<i>PrF</i>	Safe torque off error
		0x49	<i>ULC3</i>	Small-torque / Small -current fault

## 7. EtherCAT State Machine (ESM)

### ESM Diagram

The EtherCAT State machine coordinates the master and slave applications at start up and during operation. State changes are typically initiated requests of the master. They are acknowledged by the local application after the associated operations have been executed.

### Description of the states management

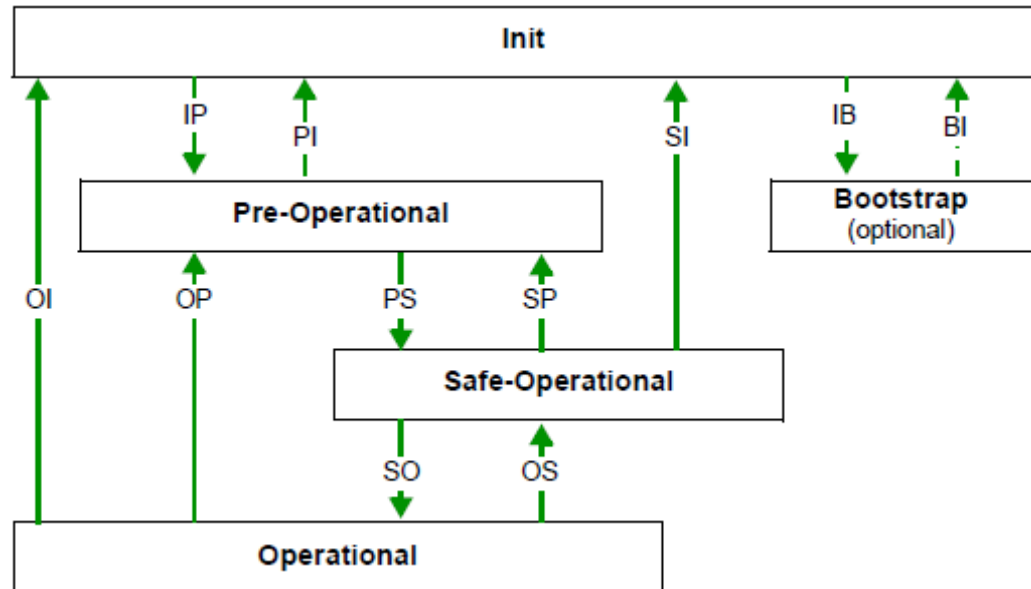

### ESM states

The state **Init** defines the foundation of the communication relationship between the master and the slaves at the application layer. Direct communication between the master and the slave is impossible at the application layer. The master uses the Init state to initialize a set of configuration registers of the EtherCAT slave controllers. If the slaves support mailbox services is configured in this state.

In the **Pre-Operational** state, the mailbox is active. Both master and slave use the mailbox and the corresponding protocol to interchange application-specific initialization data and parameters. In this state, process data communication is not possible.

If the drive does not receive a valid mapping for the process data from the EtherCAT master, it remains in this state.

In the **Safe-Operational** state, the slave application provides current input data such as limit switch data.

Output data of the master are ignored in this state. This is not a safety function.

In the state **Operational**, the slave applications deliver current input data and the drive processes the current output data from the drive, such as target velocity.

**State transitions**

State transition	Local management service	Value
IP	Start Mailbox Communication	0x02
PI	Stop Mailbox Communication	0x01
PS	Start Input Update	0x04
SP	Stop Input Update	0x02
SO	Start Output Update	0x08
OS	Stop Output Update	0x04
OP	Stop Output Update and Stop Input Update	0x02
SI	Stop Input Update, Stop Mailbox Communication	0x01
OI	Stop Input Update, Stop Mailbox Communication	0x01
IB	Start Bootstrap Mode, redirection to (BI)	0x03
BI	Restart Device	0x01

**ESM states management**

The ESM states are managed with the library: TC EtherCAT lib. See the example, step 15 page 46.

**ESM states and communication interruptions**

The ESM states are managed with the library: TC EtherCAT lib. See the example, step 15 page 46.

Some transitions in the ESM state chart will trigger a communication interruption.

These transitions suppress a service, which can be used to control the drive.

A detected fault is triggered in order to avoid losing control of the drive (only if the drive is running).

State transition	Service lost	Communication network
PI	SDO	No possible $\underline{t}$ alarm or $\underline{E r r B}$
SI	SDO, TPDO	
SP	TPDO	
OS	RPDO	If drive was enabled (Statusword = 0xXXX7) then occurs the $\underline{t}$ alarm or $\underline{E r r B}$ .
OP	PDO	
OI	SDO, PDO	

Depending on the communication status of the drive, the following services are available:

	Init	Pre-operational	Safe-Operational	Operational
PDO			TPDO, inputs only active, no outputs to drive active	X
SDO		X	X	X

---

## 8. Example: VF-MB1 with TwinCAT<sup>®</sup> “PLC - Configuration”

---

This example shows a combination of VF-MB1 with TwinCAT<sup>®</sup> option.  
When you use VF-S15, please read MB1 as S15.

---

### 8.1. Hardware

---

Connect your computer and the IPE003Z with a standard Cat 5e minimum cable (2 x RJ45, shielded twisted pair cable).

---

### 8.2. TwinCAT<sup>®</sup> software installation

---

Install the TwinCAT<sup>®</sup> software copyright BECKOFF. Example realized with TwinCAT<sup>®</sup> software version 2.11.

**Note:** The screenshots or procedure in this example can change with a new TwinCAT<sup>®</sup>  
Filename: TOSVERT\_Vxxx.xml

There are ESI files for VF-MB1 and VF-S15.

Copy this XML file on your computer in C:\TwinCAT\Io\EtherCAT.

---

### 8.3. ESI file (EtherCAT Slave Information)

---

You can use the ESI file in XML format for VF-MB1 and VF-S15.

The ESI file must be integrated into the system on the master controller.  
For example (directory path): C:\TwinCAT\Io\EtherCAT

As for acquisition of an ESI file, please contact your Toshiba distributor.

---

### 8.4. MB1 configuration

---

Realize the configuration on the Drive for Operation With CiA402 Profile in Combined Mode.

Set  $CND$  to 4 and  $FND$  to 7 and controlled with 0x6040 and 0x6041 objects.

## 8.5. System Manager: Declare your computer on Ethernet network

Start TwinCAT® system-manager®  TwinCAT System Manager

Select Options -> “Show Real Time Ethernet Compatible devices”

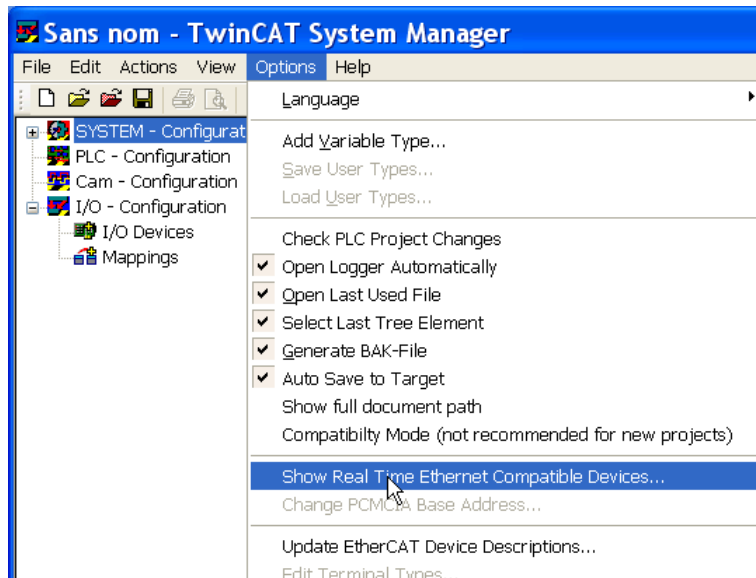

① Select your Computer Ethernet board, and “Install”.

② Enable it.

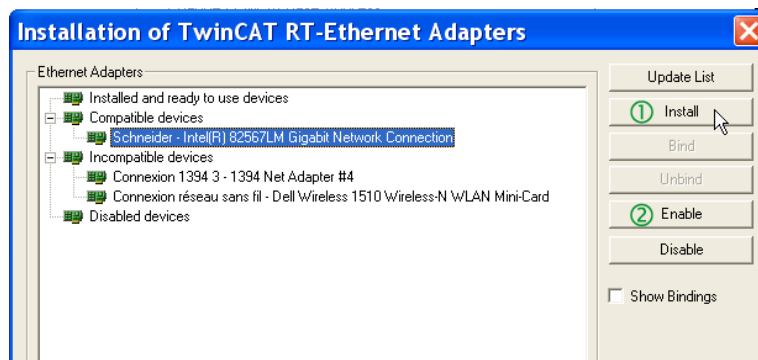

## 8.6. System Manager: Install the master

In this example we use the computer to run TwinCAT® and PLC runtime as Mater.

- ① Select "Choose Target"
- ② Select "Search (Ethernet)"

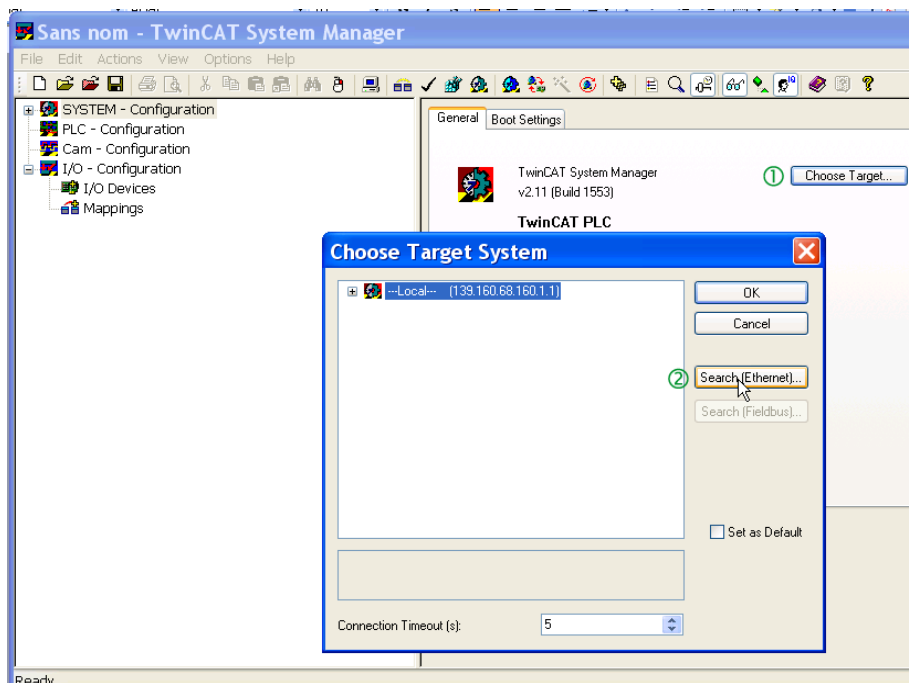

- ③ Start the "Broadcast Search"
- ④ Select your Master in the Host Name list (your computer in this example)

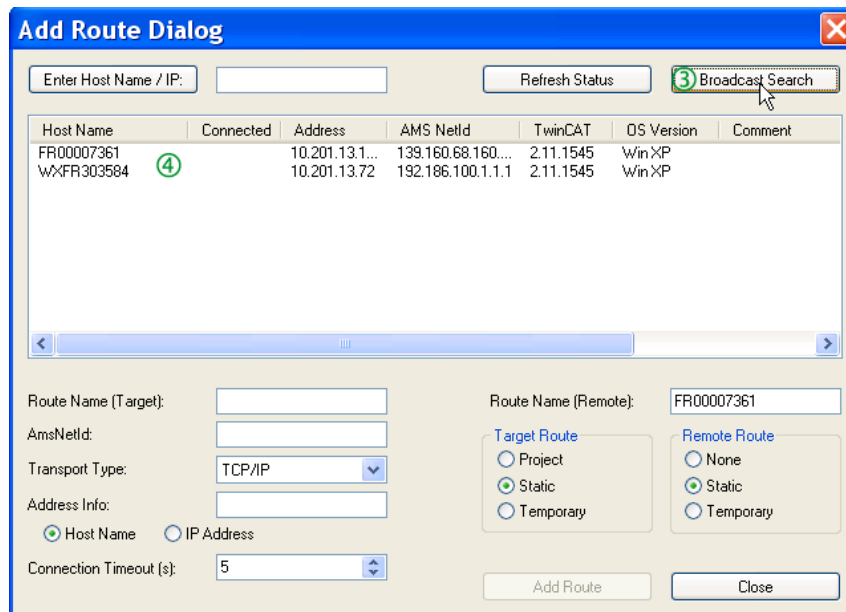

⑤ Check that you are in “config mode”

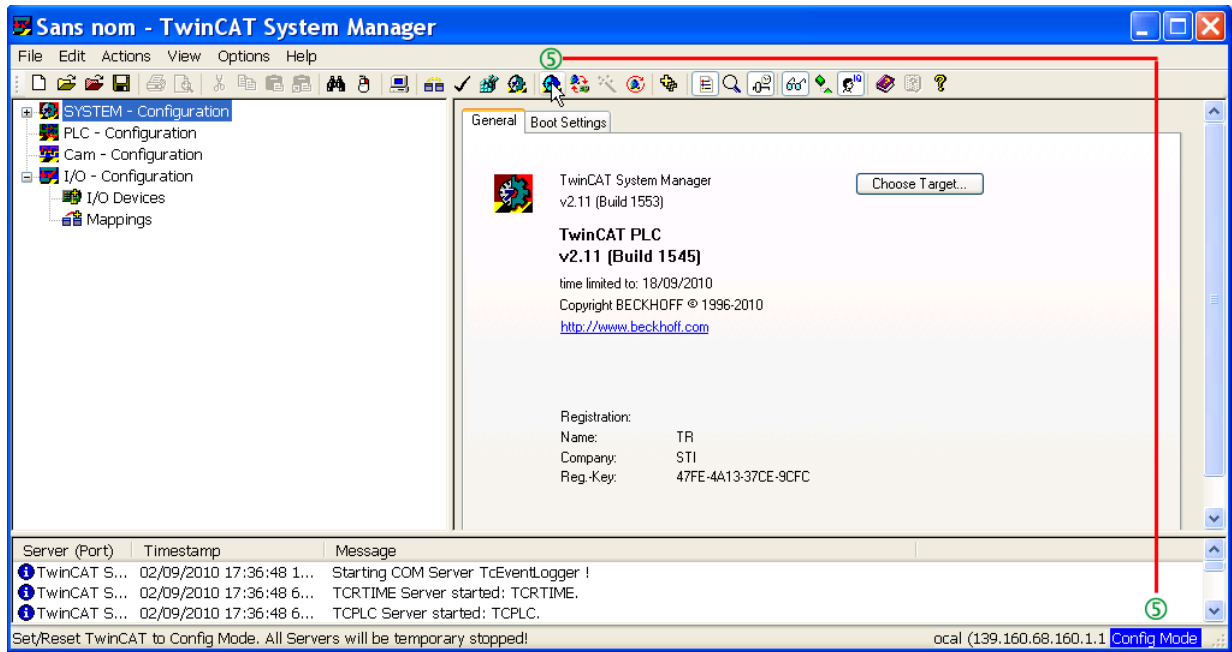



## 8.7. System Manager – Install the slave: MB1 in “PLC- configuration”

① Select the I/O Devices -> Scan Devices

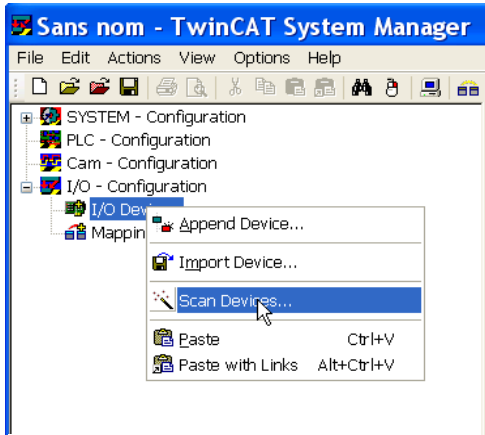

② Choose the “OK.”

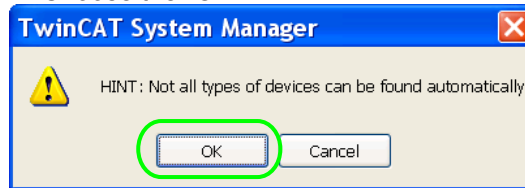

③ Check the “Device 1[EtherCAT]” -> Choose the “OK.”

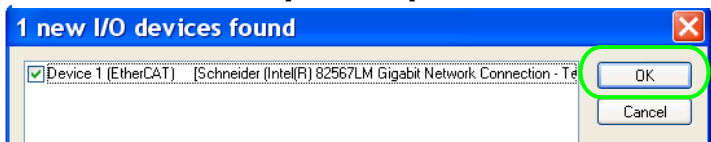

④ Choose the “Yes”.

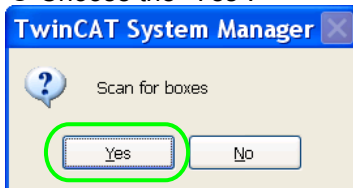

⑤ Choose the “Yes.”

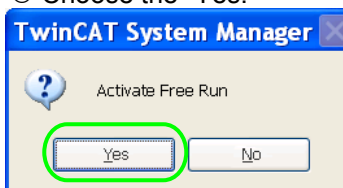

⑥ Shows the boxes and activates Free Run.

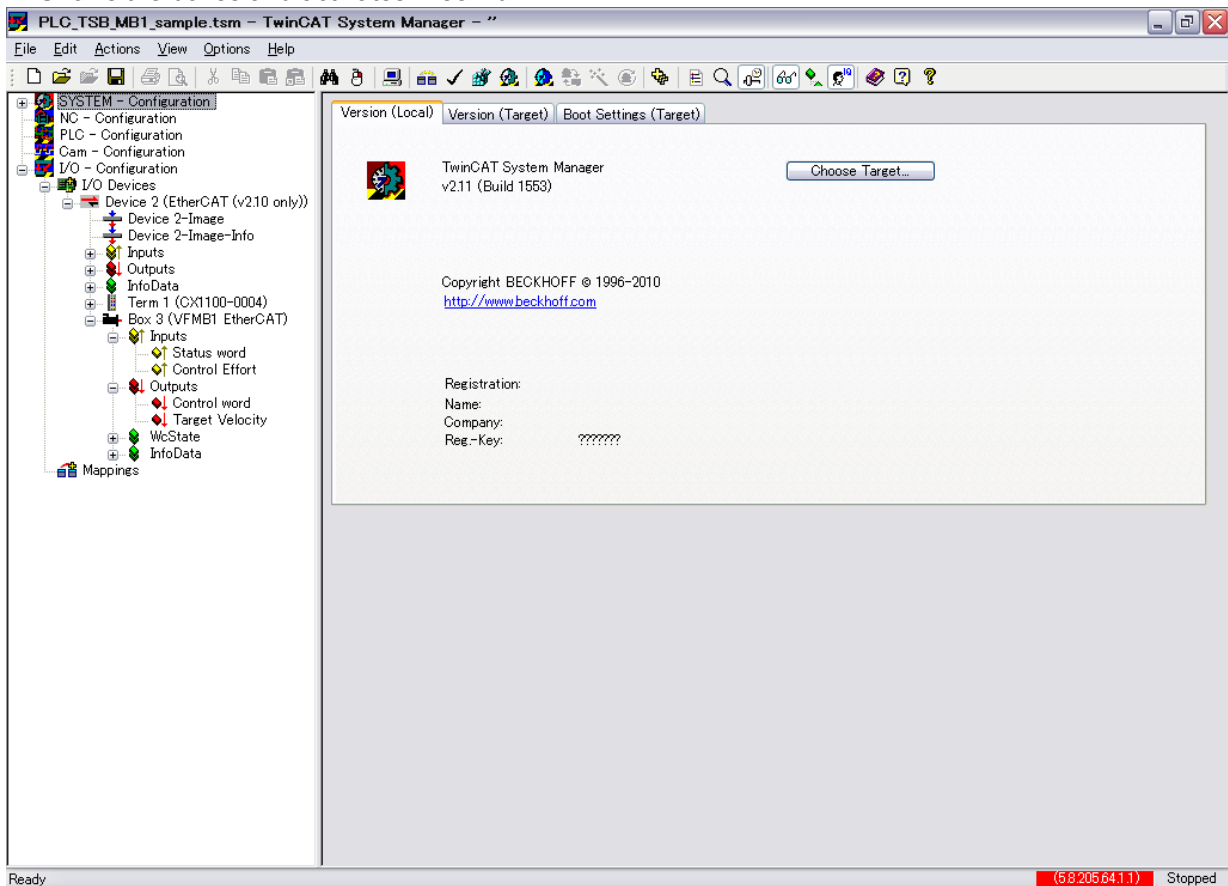

## 8.8. PLC – Control: initialization

- ① Start TwinCAT PLC control® software  TwinCAT PLC Control
- ② File -> new

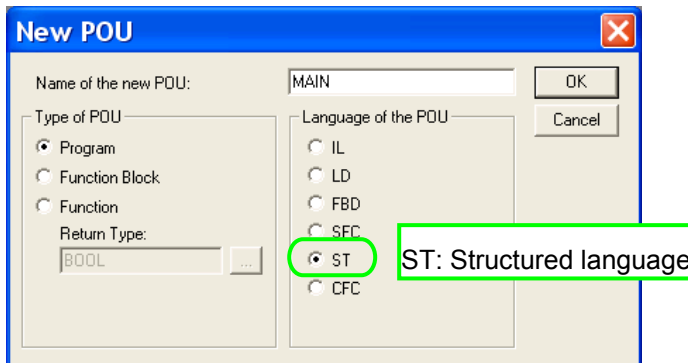
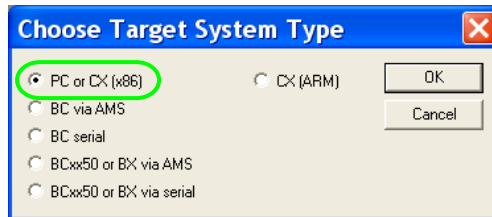

- ③ Select; Resources -> Library Manager
- ④ Add EtherCAT libraries

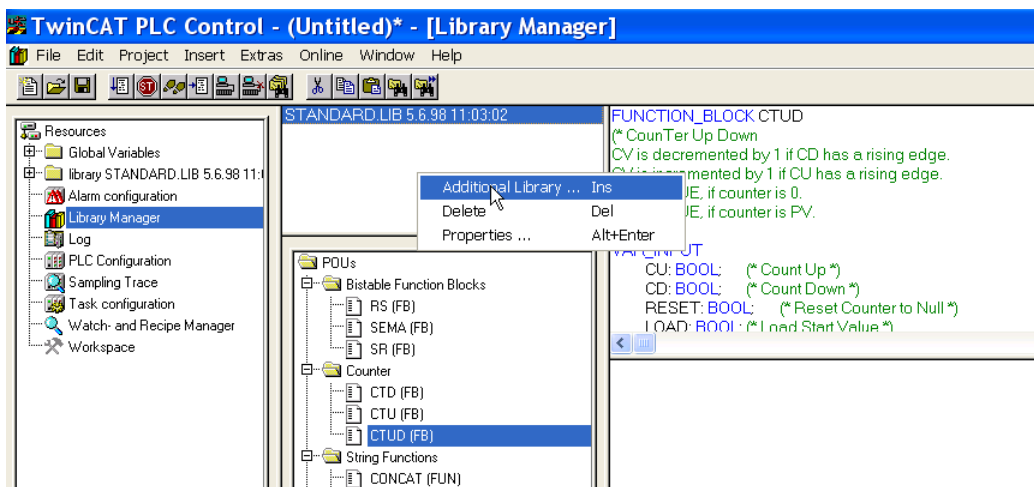

⑤ Add TcEtherCAT.lib

⑥ All EtherCAT libraries are added:

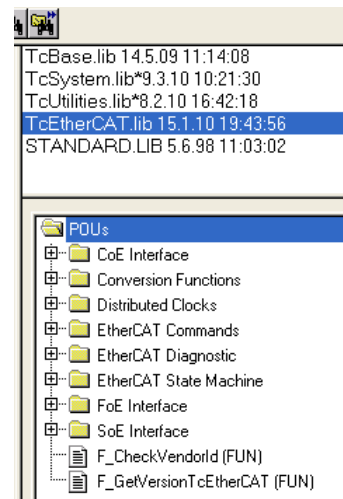
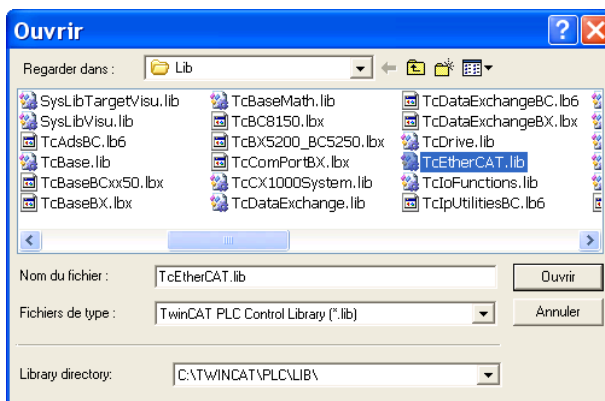

## 8.9. PLC – Control: Declare the variables

① Select Global\_Variables

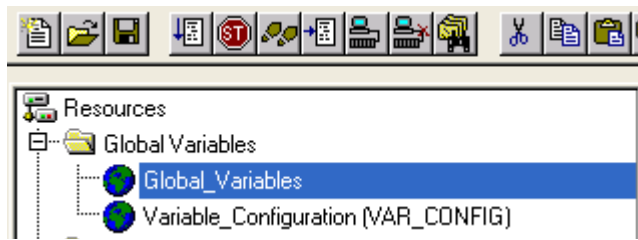

② Create the Master Global\_Variables for MB1 as below. Copy/paste the variables:

VAR\_GLOBAL

```

MB1_State AT %I*:WORD;
PLC_state AT %I*:UINT;
MB1_TPDO_Input1_Status_Word AT %I*:WORD;
MB1_TPDO_Input2_Control_Effort AT %I*:WORD;
MB1_TPDO_Input3 AT %I*:WORD;
MB1_TPDO_Input4 AT %I*:WORD;
MB1_TPDO_Input5 AT %I*:WORD;
MB1_TPDO_Input6 AT %I*:WORD;
MB1_RPDO_Output1_Control_Word AT %Q*:WORD;
MB1_RPDO_Output2_Target_Velocity AT %Q*:WORD;
MB1_RPDO_Output3 AT %Q*:WORD;
MB1_RPDO_Output4 AT %Q*:WORD;
MB1_RPDO_Output5 AT %Q*:WORD;
MB1_RPDO_Output6 AT %Q*:WORD;

```

END\_VAR

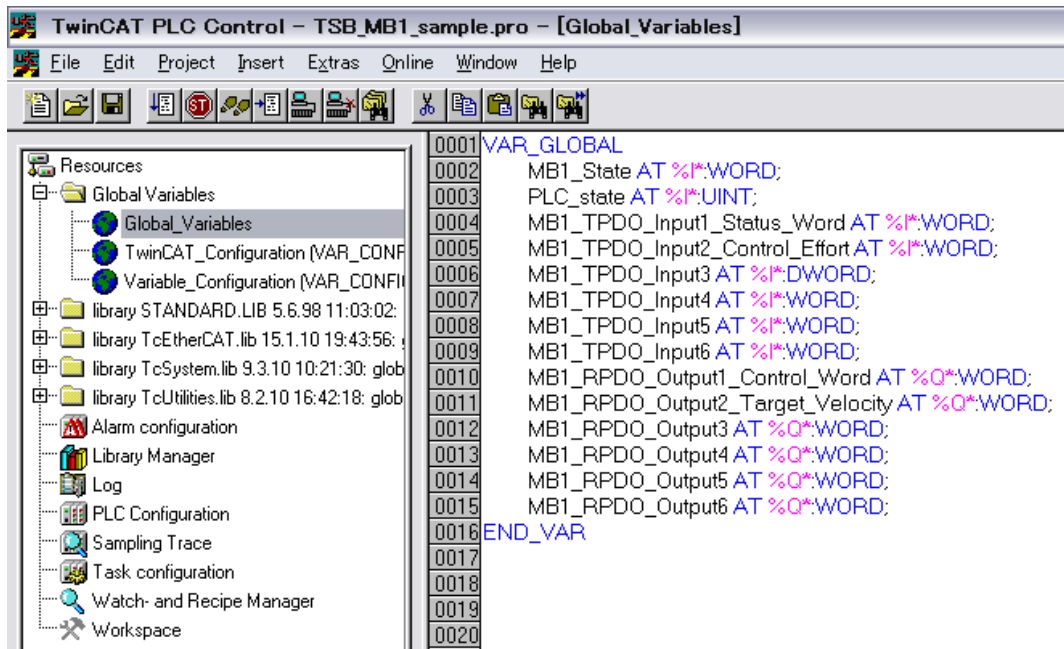

Reminder:

- RPDO (Receive PDO), containing 6 input words of the communication scanner  
 $\mathcal{C}410$  to  $\mathcal{C}415$ .
- TPDO (Transmit PDO), containing 6 input words of the communication scanner  
 $\mathcal{C}416$  to  $\mathcal{C}421$ .

③Add 1 instruction minimum in POU's before rebuild;

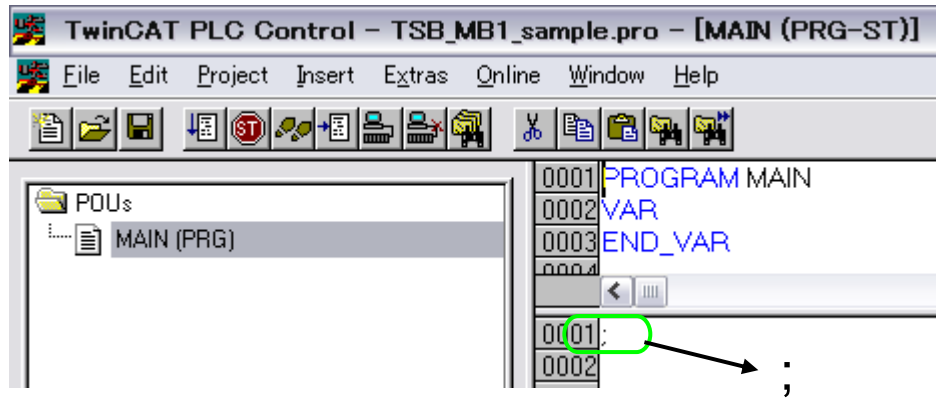

④Select: Project -> Rebuild All

⑤Check the compilation result without error.

⑥This action creates file in: C:\TwinCAT\Plc

As example, create: TSB\_MB1\_sample.tpy

## 8.10. System Manager – Append PLC Project

In System Manager software, realize the link between the Master and the slave. Creation of the links between “PLC – Configuration” and “I/O - Configuration”

①Select “Append PLC Project...”:

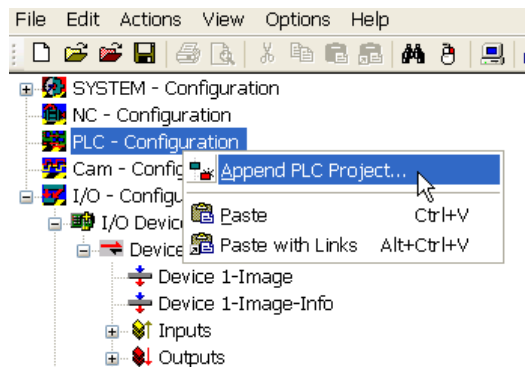

As example, select: C:\TwinCAT\Plc\TSB\_MB1\_sample.tpy

②For each parameter, create the link with the MB1/IO listing

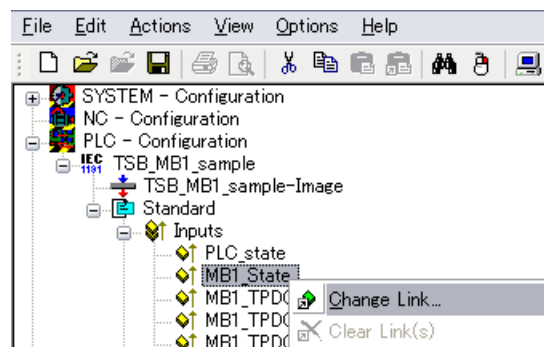

Example for “MB1\_State”

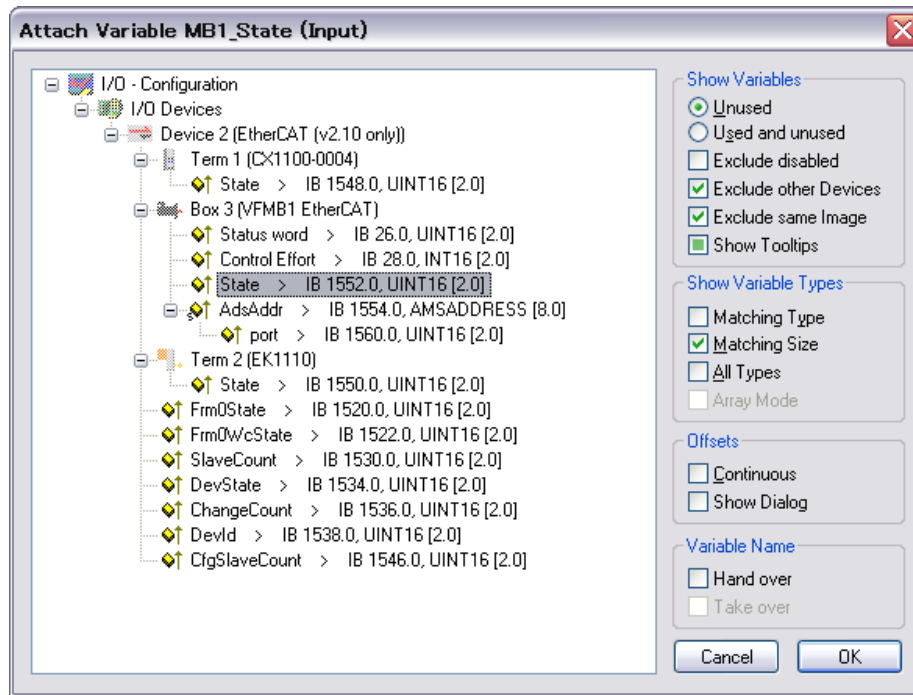

Links to create

PLC – Configuration		I/O - Configuration
Inputs	MB1_State	State
Inputs	PLC_State	DevState (with Device1)
Inputs	MB1_TPDO_input1_Status_Word	Status word
Inputs	MB1_TPDO_input2_Control_Effort	Control effort
Inputs	MB1_TPDO_input3	Available for other parameter
Inputs	MB1_TPDO_input4	Available for other parameter
Inputs	MB1_TPDO_input5	Available for other parameter
Inputs	MB1_TPDO_input6	Available for other parameter
Outputs	MB1_RPDO_Output1_Control_Word	Control word
Outputs	MB1_RPDO_Output2_Target_Velocity	Target Velocity
Outputs	MB1_RPDO_Output3	Available for other parameter
Outputs	MB1_RPDO_Output4	Available for other parameter
Outputs	MB1_RPDO_Output5	Available for other parameter
Outputs	MB1_RPDO_Output6	Available for other parameter

**Note:** if more than 6 input or output parameters are created in TwinCAT® System Manager, the MB1 will be blocked in “PreOp” State. The MB1 has maximum 6 TPDO and 6 RPDO.

③Select: Actions -> Generate Mappings.

## 8.11. PLC - Control: new compilation

Select: Project -> Rebuild All  
This action updates the information.

## 8.12. System Manager: Activate configuration

Select: Actions -> Activate Configurations

## 8.13. PLC - Control: Run

① Select: Online -> login

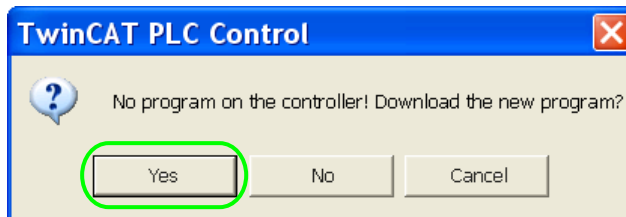

② Select: Online -> Run

The PLC and the EtherCAT fieldbus are now running.  
In TwinCAT® PLC Control, you see the list of the variables and values:

0001	MB1_State (%IB0) = 16#0008
0002	PLC_state (%IB2) = 16#0000
0003	MB1_TPDO_Input1_Status_Word (%IB4) = 16#0237
0004	MB1_TPDO_Input2_Control_Effort (%IB6) = 16#0469
0005	MB1_TPDO_Input3 (%IB8) = 16#0000
0006	MB1_TPDO_Input4 (%IB10) = 16#0000
0007	MB1_TPDO_Input5 (%IB12) = 16#0000
0008	MB1_TPDO_Input6 (%IB14) = 16#0000
0009	MB1_RPDO_Output1_Control_Word (%QB0) = 16#000F
0010	MB1_RPDO_Output2_Target_Velocity (%QB2) = 16#0708
0011	MB1_RPDO_Output3 (%QB4) = 16#0000
0012	MB1_RPDO_Output4 (%QB6) = 16#0000
0013	MB1_RPDO_Output5 (%QB8) = 16#0000
0014	MB1_RPDO_Output6 (%QB10) = 16#0000
0015	SystemInfo (%MB32768)
0016	SystemTaskInfoArr (%MB32832)
0017	
0018	

## 8.14. PLC - Control: start and stop the motor

To modify the MB1 state, refer to CiA402 state chart page 26.

Example to start motor:

1. The MB1 is on "switch on disabled" state.
2. Set "TSB\_MB1\_RPDO\_Output1\_Control\_Word (%QB0)" = 0x0006
3. The MB1 is on "ready to switch on" state.
4. Set "TSB\_MB1\_RPDO\_Output1\_Control\_Word (%QB0)" = 0x0007
5. The MB1 is on "switch on" state.
6. Set "TSB\_MB1\_RPDO\_Output1\_Control\_Word (%QB0)" = 0x000F
7. The MB1 is on "operational Enable" state.
8. Set "TSB\_MB1\_RPDO\_Output2\_Target\_Velocity (%QB2)" = 0x05DC
9. The Motor starts, and the MB1 displays "50.0"Hz
10. Set "TSB\_MB1\_RPDO\_Output1\_Control\_Word (%QB0)" = 0x0000
11. The motor stops and MB1 go back on "switch on disabled" state.

## 8.15. PLC - Control: add a library for other services

Install the library: TcEtherCAT.lib

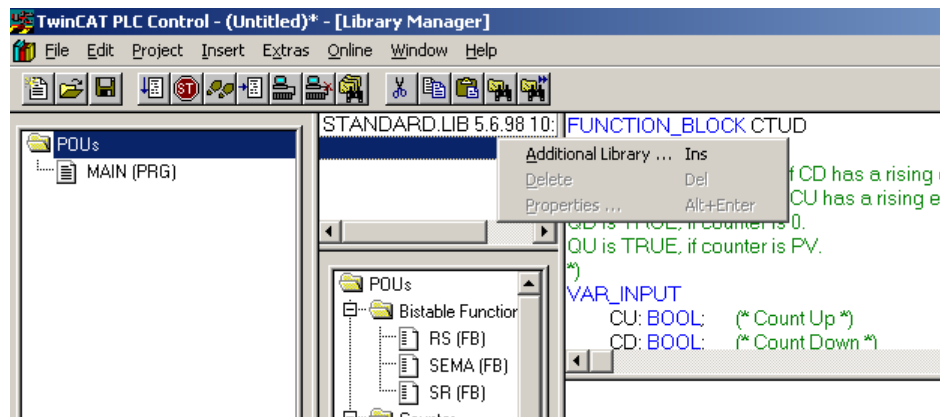

Example for exchanges with SDO

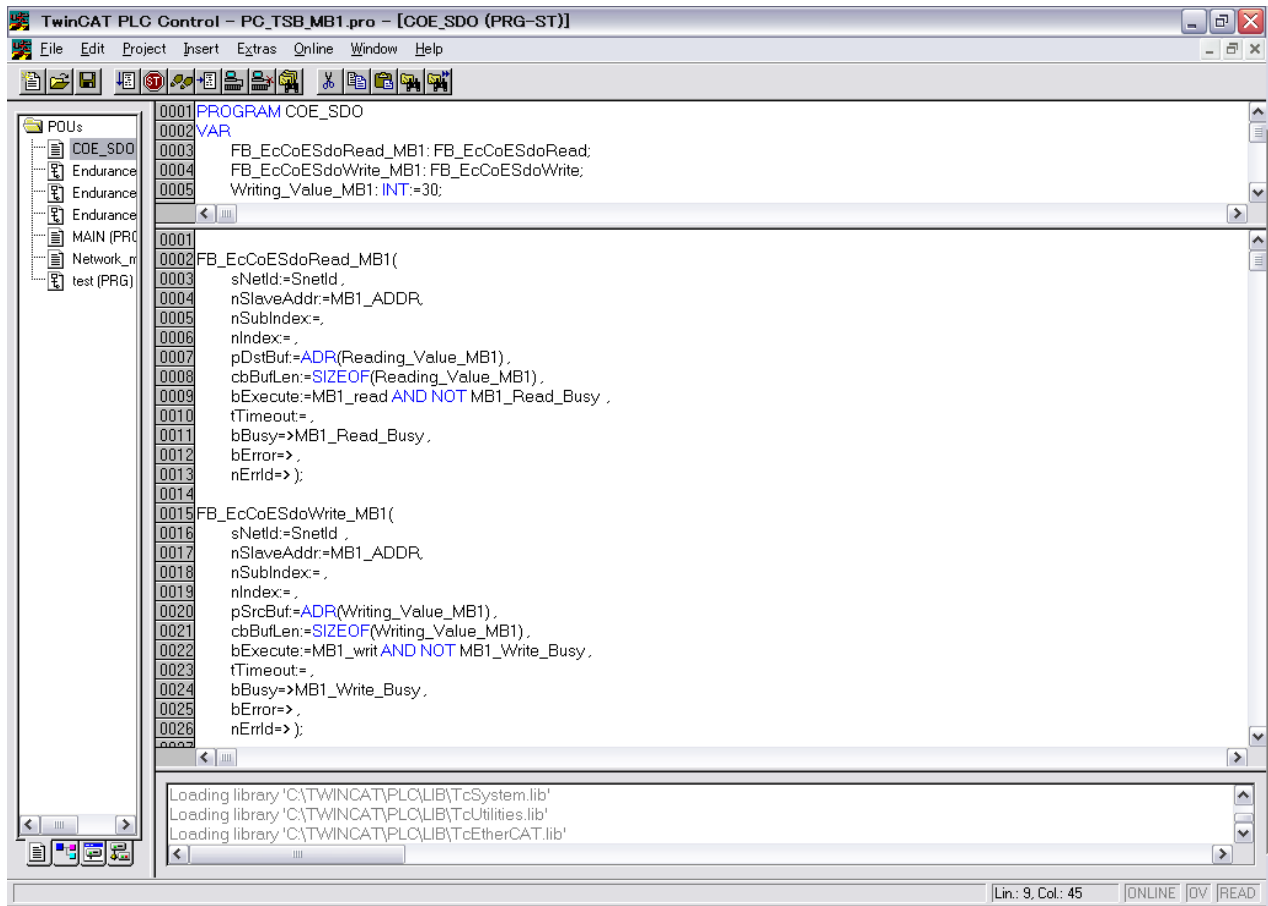

Example for exchanges with ESM states

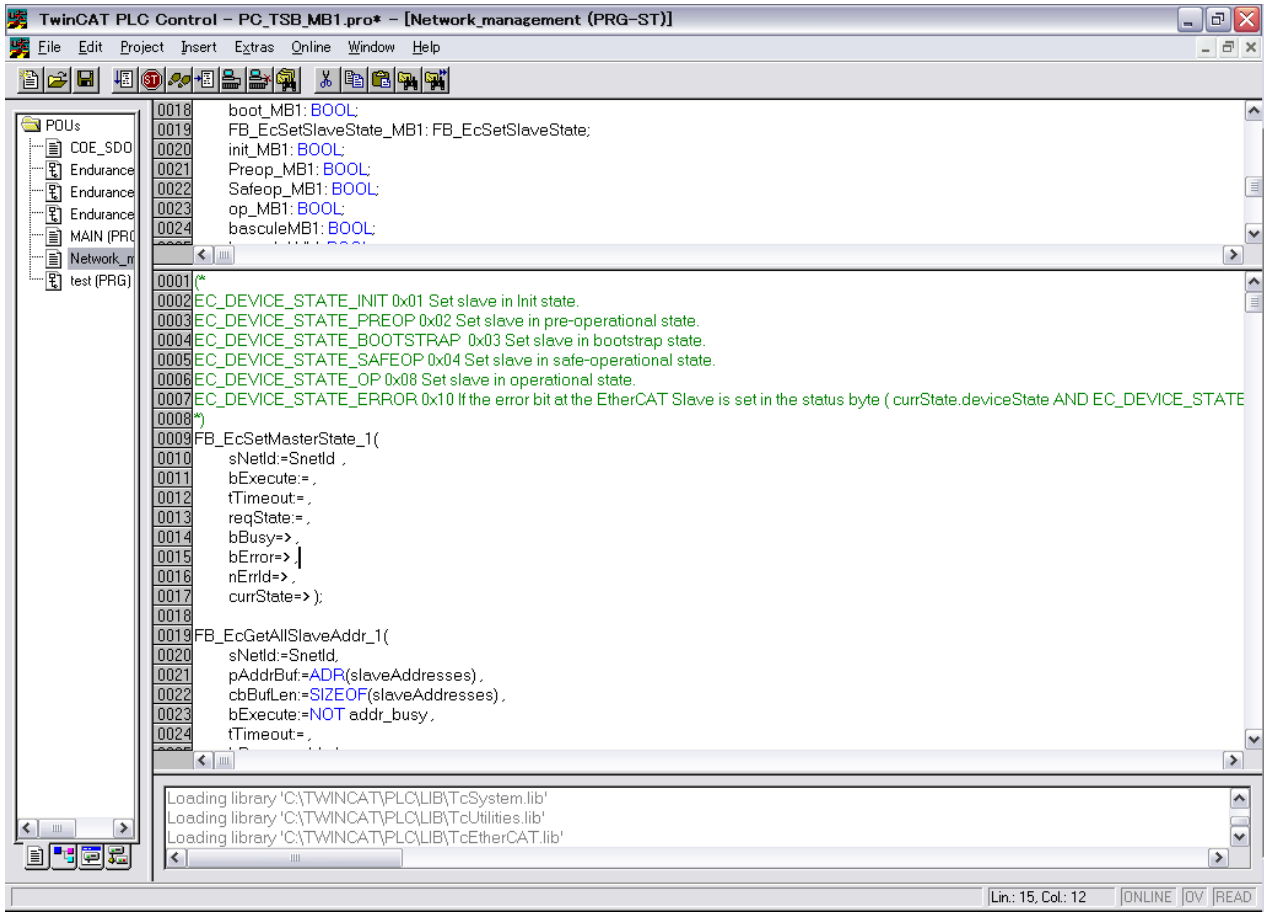

## 8.16. Method of add the PDOs

Select the "Process Data" tag

- ① Select the "PDO List" (Inputs or Outputs)
- ② Select the "PDO content"
- ③ Right click and select the "Insert..."

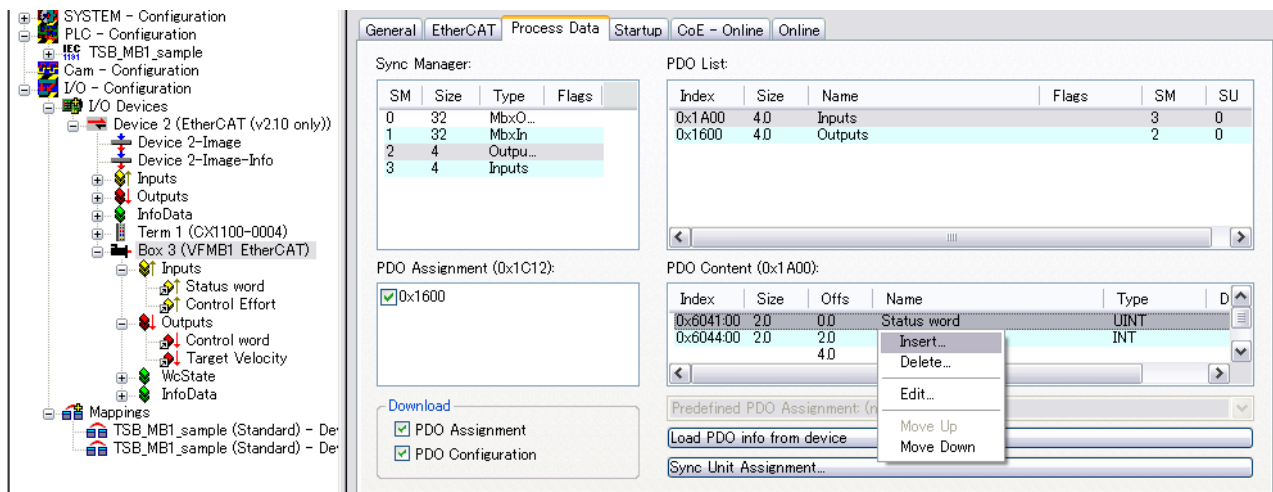



The image shows a software dialog box titled "Edit Pdo Entry". It contains several input fields and a list of options. Callout boxes with arrows point to specific fields:

- Set the Name of PDO:** Points to the "Name:" text input field.
- Set the Index of PDO:** Points to the "Index (hex):" field, which contains the value "0".
- Set the Sub Index of PDO:** Points to the "Sub Index:" field, which contains the value "0".
- Set the Data Type of PDO:** Points to the "Data Type:" dropdown menu, which is currently set to "(none)".
- Set the Bit Length of PDO:** Points to the "Bit Length:" field, which contains the value "1".

At the bottom of the dialog, there is a section titled "From Dictionary:" containing a list of hexadecimal codes and their corresponding descriptions:

- 0x2880 - Free notes
- 0x2C91 - Alarm code
- 0x2D00 - Output frequency (Real time)
- 0x2D01 - Inverter status (Real time)
- 0x2D03 - Output current (Real time)
- 0x2D04 - Voltage at DC bus (Real time)
- 0x2D05 - Output voltage (Real time)
- 0x2D06 - Status of input terminal block
- 0x2D07 - Status of output terminal block
- 0x2D16 - Estimated speed (Real time)
- 0x2D18 - Torque
- 0x2D20 - Torque current
- 0x2D22 - Feedback value of PID (Real time)
- 0x2D23 - Motor overload
- 0x2D24 - Inverter overload