

Multi-Loader

Parameter writer Instruction Manual PWU003Z

Notice



1. Make sure that this instruction manual is delivered to the end user of the inverter.
2. Read this manual before first using the communications function, and keep it handy as a reference for maintenance and inspections.
3. All information contained in this manual are subject to change without notice. Please confirm the latest information on our web site "www.inverter.co.jp".

Safety precautions

On the inverter and in its instruction manual, important information is contained for preventing injuries to users, damages to assets, and for proper use of the inverter.

Read the instruction manual attached to the inverter along with this instruction manual to completely understand the safety precautions, the symbols and indications shown below. Please adhere to the contents of these manuals at all times.



Explanation of markings

Marking	Meaning of marking
 Warning	Indicates that errors in operation may lead to death or serious injury.
 Caution	Indicates that errors in operation may lead to injury (*1) to people or that these errors may cause damage to physical property. (*2)

(*1) Such things as injury, burns or shock that will not require hospitalization or long periods of outpatient treatment.

(*2) Physical property damage refers to wide-ranging damage to assets and materials.



Meanings of symbols

Marking	Meaning of marking
	Indicates prohibition (Don't do it). What is prohibited will be described in or near the symbol in either text or picture form.
	Indicates an instruction that must be followed. Detailed instructions are described in illustrations and text in or near the symbol.
	-Indicates warning. What is warned will be described in or near the symbol in either text or picture form. -Indicates caution. What the caution should be applied to will be described in or near the symbol in either text or picture form.



■ Limitation of use

⚠ Safety precaution	
▼ Never use this unit with any inverter other than TOSVERT series inverters. Doing so may cause an accident.	





■ Handling in general

⚠ Warning	
 Never Disassemble	▼ Never disassemble, modify or repair the product. Disassembling the product may cause electric shocks, fire or injuries. For repairs, call your sales/repair agency.
 Prohibited	▼ Do not put or insert foreign objects such as waste cable, bars, or wires into the product. It may lead to electric shocks or fire. ▼ Do not splash water over the product, and do not wipe the body with a wet cloth. It may lead to electric shocks or fire.
 Mandatory action	▼ Turn off input power before wiring. Wait at least 15 minutes and check to make sure that the charge lamp (on the inverter unit) is no longer lit. ▼ Turn off the power immediately in case of any abnormalities such as smoke, smell or abnormal noise. Neglect of these conditions may lead to fire. For repairs, call your sales/repair agency.



■ Transportation and usage

⚠ Warning	
 Prohibited	▼ Do not install or operate the inverter if it is damaged or any part of it is missing. Operating a defective inverter may lead to electric shocks or fire. For repairs, call your sales/repair agency. ▼ Do not put any flammable material near the product. It may catch fire due to the product sparking in the case of a malfunction. ▼ Do not connect a LAN cable or telephone modular cable to Parameter writer. Doing so may cause a failure or accident.
 Mandatory action	▼ Electrical construction work must be done by a qualified expert. Connection of input power by someone who does not have expert knowledge may result in fire or electric shock. ▼ Operate under the environmental conditions prescribed in the instruction manual. Operations under any other conditions may result in malfunction. ▼ An emergency stop inverter must be installed that fits with system specifications (e.g. shut off input power then engage mechanical brake). Operation cannot be stopped immediately by the inverter alone, thus risking an accident or injury. ▼ Use the attached cable for connecting this optional unit. The use of any other option may result in an accident.
⚠ Caution	
 Prohibited	▼ Do not use the product in any place subject to vibrations or it may fall. This may lead to the product falling and causing injury. ▼ Do not use nickel-cadmium rechargeable battery or manganese battery. This may lead to liquid spill and fire. ▼ Do not use different type of battery together, or new battery and reuse one together This may lead to liquid spill and fire.

■ Operations

 Warning	
 Prohibited	<ul style="list-style-type: none"> ▼ Do not apply a dropping shock or other physical shocks. Otherwise, damage or malfunction will result. ▼ Do not pull on the cable and connector. It may cause damage or error. ▼ Do not bring any regions of your body into contact with the inverter terminals when power is supplied to the inverter. Contact during the power-on status of the inverter can result in electric shock.
 Mandatory action	<ul style="list-style-type: none"> ▼ Use an additional safety inverter with your inverter or system to prevent a serious accident due to the unit malfunctions. Usage without an additional safety inverter may cause an accident. ▼ Make sure to check that the parameter data from this product is not accidentally copied to the wrong inverter. Usage with wrong parameter may result in an accident.
 Caution	
 Mandatory action	<ul style="list-style-type: none"> ▼ Set up "Communication time-out (<i>F803</i>, <i>F804</i> and <i>F808</i>)" (see the inverter instruction manual for details) to stop the inverter when Parameter writer is deactivated by an unusual event such as tripping, an operating error, power outage, failure, etc. Deactivated Parameter writer may cause an accident, if the "Communication time-out" is not properly set up. ▼ Please back up the data used with this unit. The stored data might be lost according to using condition of the SD card. Please be forewarned that our company cannot make compensation for the damage depend on the loss of the stored data.

■ Disposal

 Caution	
 Mandatory action	<ul style="list-style-type: none"> ▼ If you dispose off this unit, have it done by a specialist in industrial waste disposal*. Improper disposal may result in explosion of capacitors or produce noxious gases, resulting in injury. (*) Persons who specialize in the processing of waste and known as "Industrial Waste Product Collectors and Transporters" or "Industrial Waste Disposal Persons." If the collection, transport and disposal of industrial waste is done by someone who is not licensed for that job, it is a punishable violation of the law (Laws in regard to cleaning and processing of waste materials).

■ Notes on operation

Notes	
	<ul style="list-style-type: none"> ▼ Avoid using in a place where ambient temperature or/and humidity change sharply. ▼ Keep the transmission cable separate from the power cable of the inverter to prevent the inverter from malfunctioning due to electromagnetic noise. ▼ The integrity of data storage is guaranteed for up to 5 years. ▼ The operating life of the data storage inverter is 10000 operations. Do not execute more than 10000 writing operations. ▼ Do not turn off power or remove the connection cable between the inverter and Parameter writer or take off SD card while a copying operation is in progress. If the inverter power is turned off or the connection cable is removed while parameters are being copied, data cannot be written correctly. ▼ Do not copy data from Parameter writer to inverter and inverter to Parameter writer while the inverter is running. Some of the parameters cannot be written when the inverter is in operation. ▼ When a copying operation is executed between two inverters with different capacities, some of the parameters that vary with the capacity of the inverters will also be copied. Therefore, when copying the parameters between inverters with different capacities or voltage class, the type information parameters of the inverter should always be initialized. See the inverter instruction manual on how to initialize their parameters.

Contents

SAFETY PRECAUTIONS	1
1. SETUP PROCEDURE.....	5
2. INTRODUCTION	6
3. RECEIPT OF THE PARAMETER WRITER	7
3.1. Presentation	8
3.2. Description	9
4. CONNECTING THE PARAMETER WRITER.....	11
4.1. Connection to a PC.....	11
4.2. Connection to an inverter	12
5. CONFIGURATION TRANSFERS.....	13
5.1. Loading a configuration from an inverter	13
5.2. Transferring the configuration to an inverter	14
5.3. Transferring the configuration to more than one inverter using Quick Store	15
6. PARAMETER WRITER MENUS	16
6.1. Parameter writer main menu	16
6.2. Action: Load configuration from Parameter writer to inverter	17
6.3. Action: Load configuration from inverter to Parameter writer	18
6.4. Quick Store mode	19
6.5. Supervision	20
6.6. Parameter settings: Batteries.....	21
6.7. Parameter settings: Diagnostics.....	22
6.8. Parameter settings: Password	23
6.9. Parameter settings: Display	23
7. SPECIFICATIONS	24
8. WARRANTY	24

1. Setup procedure

Thank you for purchasing Parameter writer (PWU003Z) for TOSVERT series inverters.

Before using Parameter writer, carefully read this instruction manual in order to completely and correctly utilize Parameter writer's excellent performance.

After reading this instruction manual, please keep it handy for future reference.

1. Receive and inspect the Parameter writer

Check that the reference printed on the label is the same as that on the purchase order. Remove the Parameter writer from its packaging and check that it has not been damaged in transit.

2. Connect the Parameter writer (see chapter 4)

- To a PC
- To an inverter

3. Copy inverter configurations (see chapter 5)

- Load a configuration onto the Parameter writer
- Transfer a configuration to an inverter
- Transfer a configuration to several inverters (Quick Store)

4. Parameter writer menus (see chapter 6)

2. Introduction

The Parameter writer “PWU003Z” is a standalone tool for transferring configuration files to inverters with their power on or off.

- The Parameter writer is used to set inverter parameters by loading a configuration file onto the inverter(s). (Inverters must have the same reference. If the reference is not the same, the fault occurs before the data is transferred.). The parameters can be set with them before they are powered up.

Duplicating or generating configuration files

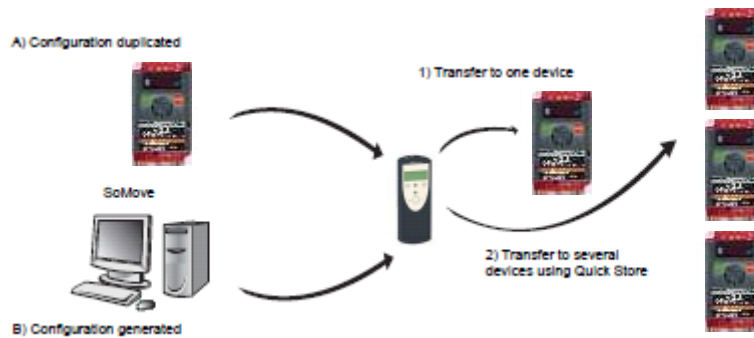

- A) The inverter's configuration file is copied to the Parameter writer's SD card. See the procedure on section 5.1.
- B) The configuration file is generated by PCM software then transferred to the Parameter writer's SD card. See the procedure on section 5.1.
- 1) The user selects and then transfers the configuration file from the Parameter writer to the inverter. See the procedure on section 5.2.
- 2) Once the initial transfer is complete, the user can use Quick Store mode, which allows the Parameter writer to load the same update file on several inverters in succession. (See section 5.3)

All representations of the VF-nC3 inverter throughout this document are given by way of example only to symbolize an inverter.

All bold text in the manual (e.g. "**Main menu / Action**") corresponds to the messages displayed on the Parameter writer screen.

3. Receipt of the Parameter writer

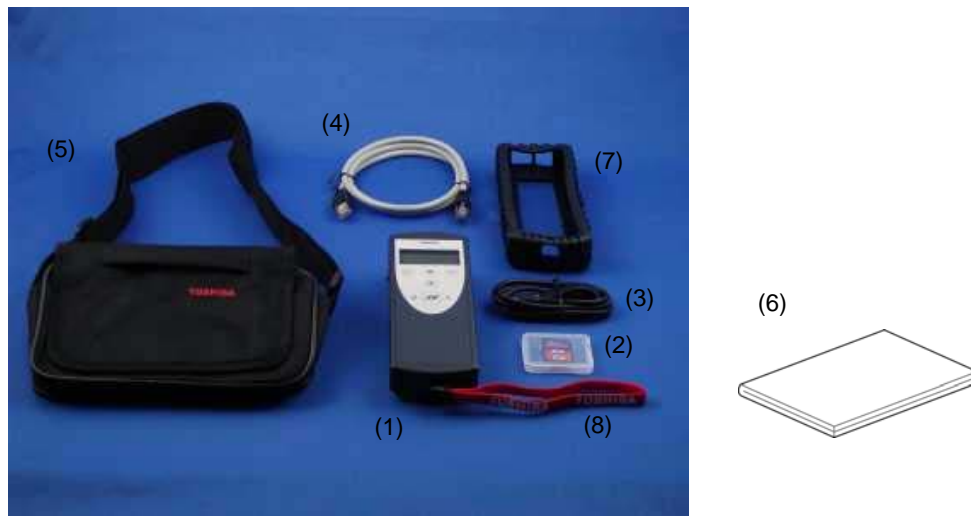
**Product reference:**

Check that the product reference printed on the label is the same as that on the delivery note. This should also correspond with the number on the purchase order.

Contents of the Parameter writer box (PWU003Z)

Check that the Parameter writer box contains the following:

- (1) Parameter writer
- (2) SD card
- (3) Standard USB type A to Mini-B cable
- (4) RJ45 (RJ45/RJ45) cable(Length: 1m)
- (5) Carry case
- (6) User's manual (Japanese and English)
- (7) Impact resistant cover
- (8) Wrist strap

3.1. Presentation

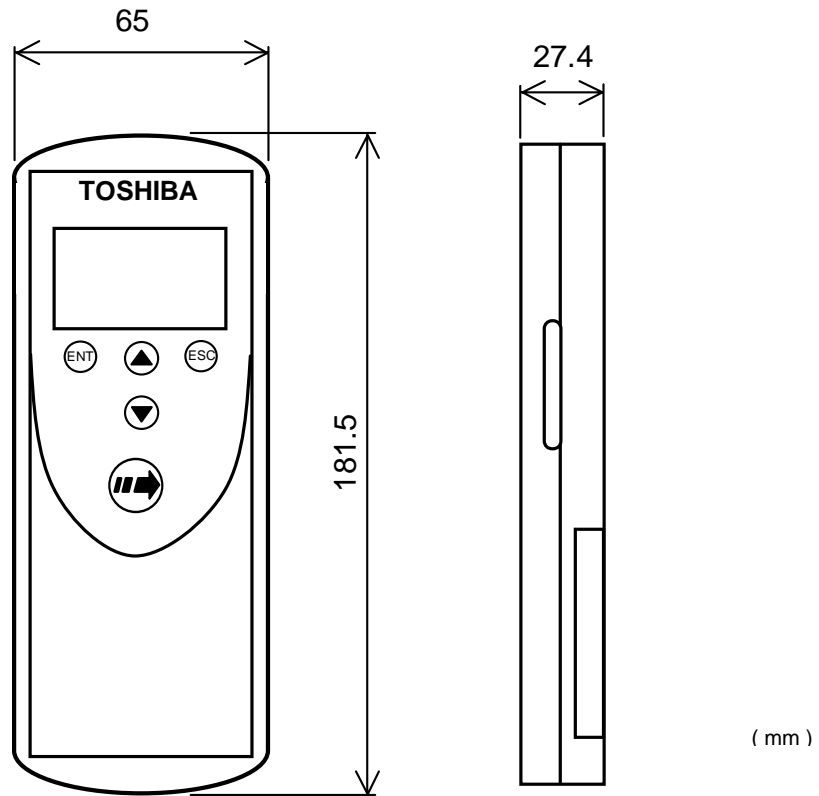

Figure 1

Approximate weight

250 g (including batteries)

3.2. Description

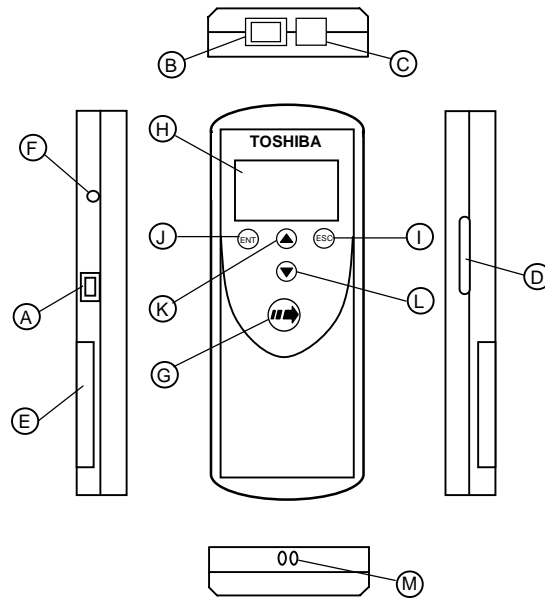

Figure 2

Letter	Description	Comments
A	Mini-B USB connector	The connection between the Parameter writer (USB Mini-B type) and the PC (USB type A) is via a 1 m (3.28 feet) USB type A to Mini-B cable.
B	RJ 45 connector	The connection between the Parameter writer and the inverter is via a RJ45 cable to load and transfer configuration files or updated application.
C	RJ11 connector with label cover	For factory use only.
D	SD card slot	The SD card receives and stores the files. One SD card is supplied with the Parameter writer.
E	Battery compartment	It can take 4 normal batteries and rechargeable batteries.
F	Power ON/OFF button	Press for 2 seconds to turn the tool on or off.
G	Quick Store key	Press this key to transfer data from the Parameter writer to the inverter after an initial transfer in Quick store mode.
H	Screen	The screen comprises 2 lines of 16 characters.
I	ESC key	Returns to the previous screen.
J	ENT key	Confirms the parameter selection or cancels messages.
K	Up arrow key	For menu navigation.
L	Down arrow key	For menu navigation.
M	Holes	For wrist strap

Data storage

One SD card is supplied with the Parameter writer. Any standard SD card and SDHC card are compatible with the Parameter writer. (SD card is used in this instruction manual for explanation)

The SD card format must be FAT32.

Language

The menus are in English, Japanese, Spanish, German, Italian and French. (Default language is set to English)

Power supplies

Two kinds of batteries are available for powering the Parameter writer:



- 4 x LR6 (AA) alkaline batteries (batteries not attached)
- NiMH rechargeable batteries (batteries and charger not attached)

Battery life

Depending on the type of batteries used, the Parameter writer can transfer up to 300 configuration files.

Power save feature

To prolong battery life, a sleep mode is activated within a programmable time delay; the Parameter writer is reactivated by pressing the ON/OFF button. (See the display parameters menu on section 6.9.) Connection to a powered-up PC or inverter can also help conserve battery power, as the power supply from the connected inverter takes over from the batteries.

 Caution	
 Mandatory action	<ul style="list-style-type: none">▼ Do not use nickel-cadmium rechargeable battery or manganese battery. This may lead to liquid spill and fire.▼ It is not possible occasionally to read according to the kind of the SD card and record condition.▼ It is not warrantable operation and the power supply for all SD cards.▼ The specification of the SD card might be changed for reasons of manufacturer's own. It is not possible occasionally to operate normally according to the changes.▼ Even if it is the same type-form, the specification might be different in each selling area according to the SD card.▼ The data file recorded except the specified format might not to be able to read normally and not displayed the file name.▼ The SD card with the security function cannot be used.▼ The described specification might change without notice.

4. Connecting the Parameter writer

This section describes the various ways of connecting the Parameter writer. Default language is set to English. Refer to section 6.9 and change the language setting, according to need.

4.1. Connection to a PC

There are two ways of storing files on the SD card:

- Insert the SD card in the Parameter writer and connect the Parameter writer to the PC via the standard USB type A to Mini-B cable (see Figure 3)
- OR
- Insert the SD card in the SD card reader on the PC (see Figure 4)

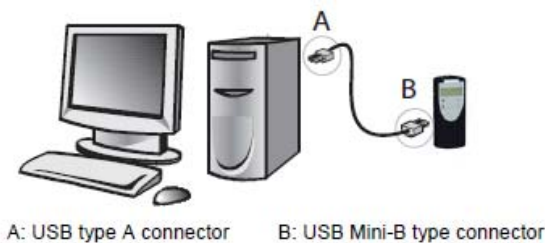

Figure 3



Figure 4

For both these methods, the SD card is recognized as an external storage device. The SD card operates in Windows operating system explorer using the same copy/paste actions as any standard external storage media. (OS: Windows XP/Vista/7 operating system)

Note:

- Windows is the registered trademark of Microsoft Corporation in U.S.A. and other countries.
- The PC must be on and operational before connecting the Parameter writer to avoid an incorrect start up of the PC.
- The SD card must not be removed when the Parameter writer is on and a transfer is in progress. Otherwise, data on the SD card may be lost.
- The file name length is 255 letters maximum.
- The number of files that can be saved in the SD card is up to 65535 or less.
(N.B. Too many files cause slow key operation response and display. Number of files should be little.)
- The following priority rules come into play when the Parameter writer is connected to a PC:
 - If no transfer is in progress between the Parameter writer and the drive, the connection to the inverter is ignored and the Parameter writer is detected by the PC.
 - If a transfer is in progress between the Parameter writer and the inverter, the user has to wait until the transfer is complete. The Parameter writer must then be reconnected so the PC can detect it.

Source of configuration files

-If a inverter's configuration is to be duplicated, it is copied to another inverter via the Parameter writer. See "Loading a configuration from inverter" on section 5.1 and "Configuration transfers" on section 5.2 and 5.3.

4.2. Connection to an inverter

Parameter files can be transferred to the inverter in whichever A and B condition.

A. When the inverter is off, the Parameter writer is powered

B. When the inverter is on, the Parameter writer is powered by the inverter via the RJ45 cable.



Connect the Parameter writer to the inverter as following procedures

A.

1. Insert the Parameter writer's communication cable into the inverter's RJ45 communication port. Refer to the inverter's installation manual for more information about how to perform this task.
2. Perform the desired transfer.
3. Remove the Parameter writer communication cable from the inverter.

B.

1. Remove all power from the inverter and all enclosures housing the inverter and wait more than 15 minutes and more to allow the DC bus of the inverter to discharge.
2. Insert the Parameter writer's communication cable into the inverter's RJ45 communication port. Refer to the inverter's installation manual for more information about how to perform this task.
3. Install and close all covers and doors before applying power to the inverter. The inverter must be powered on before performing an upload or download.
4. Perform the desired transfer.
5. Upon completing the transfer, remove all power from the inverter and the enclosures housing the inverter and wait 15 minutes to allow the DC bus of the inverter to discharge.
6. Remove the Parameter writer communication cable from the inverter.

5.2. Transferring the configuration to an inverter

This procedure allows the user to select the configuration file to be transferred to the inverter.

The user must already have:

- Loaded the inverter configuration file ("*.CFG") onto the Parameter writer (see section 5.1)
- OR
- Generated the configuration file using PCM software and loaded this file onto the Parameter writer

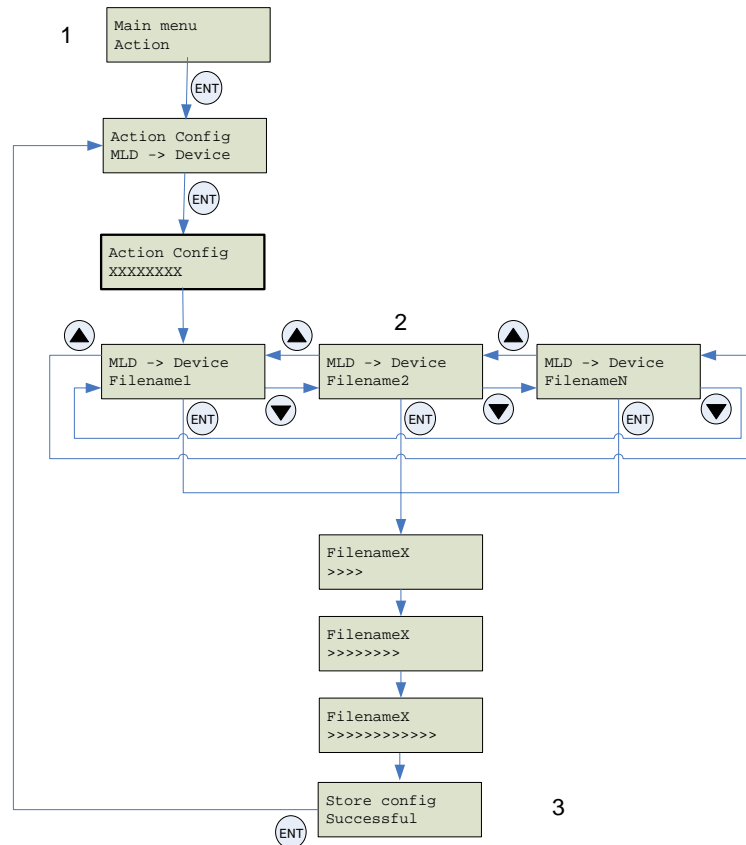

STEP	Procedure
1	<ul style="list-style-type: none"> • Turn the Parameter writer on using the ON/OFF button “F” (see section 3.2). • Connect the Parameter writer to the inverter using the RJ45 cable (see section 4.2). • Press “ENT” when the screen displays “Main menu / Action”. • Press “ENT” when the screen displays “Action Config / MLD -> Device”.
2	<ul style="list-style-type: none"> • Select the file to be transferred using the arrow keys and press “ENT” to start the transfer. (see section 6.7).
3	<ul style="list-style-type: none"> • The configuration has been transferred successfully from the Parameter writer. Disconnect the RJ45 cable from the inverter. • Pressing “ENT” returns the user to the “Action Config / MLD -> Device” menu.

Note :

- Keep on pushing ESC key if the process of searching communication mode is canceled.
- Display is changed faster by keeping on pushing ▲ or ▼ key.

6. Parameter writer menus

6.1. Parameter writer main menu

On power-up, the "Parameter writer / Version "x.x"" menu is displayed on the screen.

The diagram below shows the various menus that can be accessed from the Parameter writer main menu.

Main menu / Action accesses the following functions:

- Load from Parameter writer to inverter
- Load from inverter to Parameter writer

Main menu / Device accesses the following information:

- Device type
- Device version

Main menu / Parameters accesses:

- Battery parameters
- Diagnostic parameters
- Password parameters
- Display parameters

Main menu / About MLD accesses:

- Parameter writer version information

The Quick Store key (see section 3.2) allows the user to transfer the most recent configuration file or update the inverter (see section 6.4).

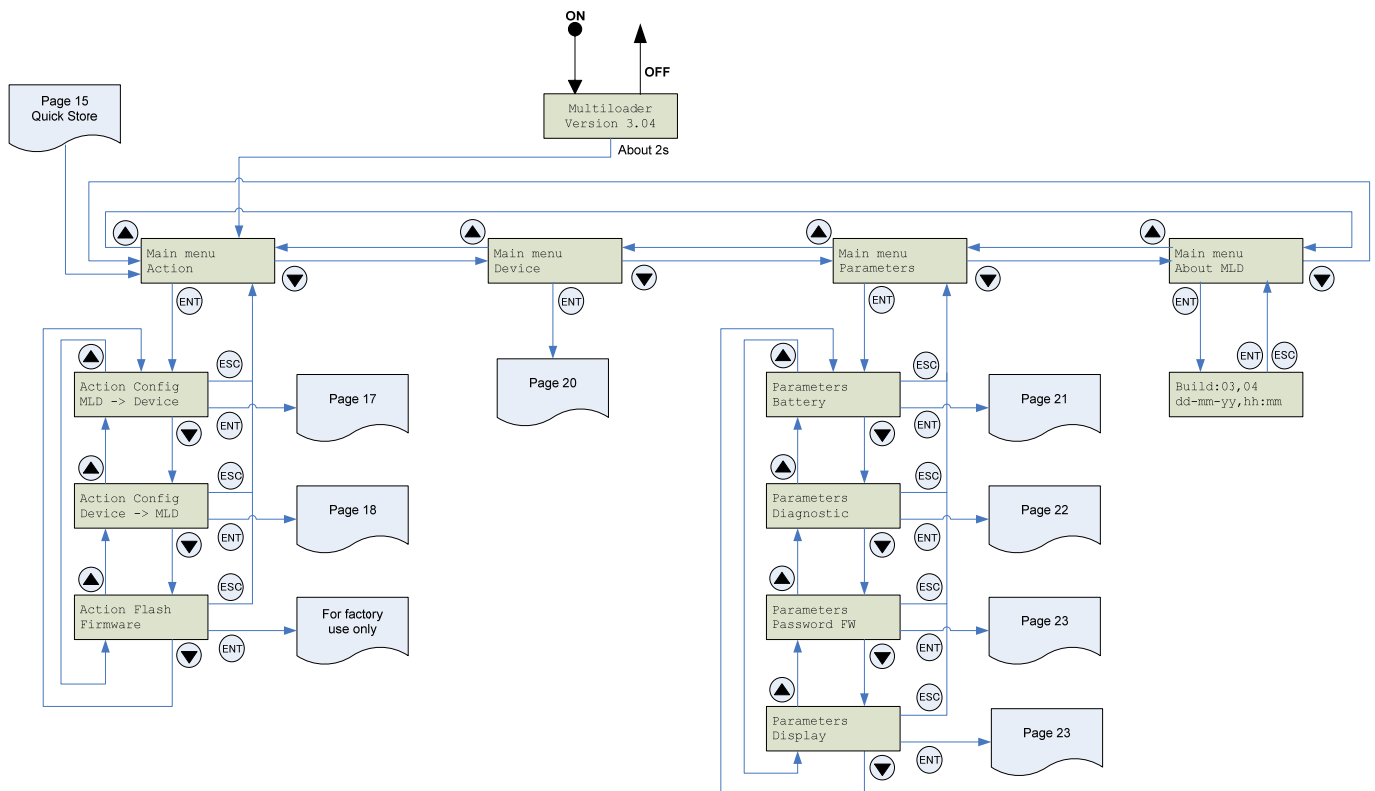

6.2. Action: Load configuration from Parameter writer to inverter

The diagram below shows the "Action Config / MLD -> Device" menu accessible from "Main menu / Action".
 "Action Config / MLD -> Device" : This menu accesses the transfer function for loading configurations from the Parameter writer to the inverter.

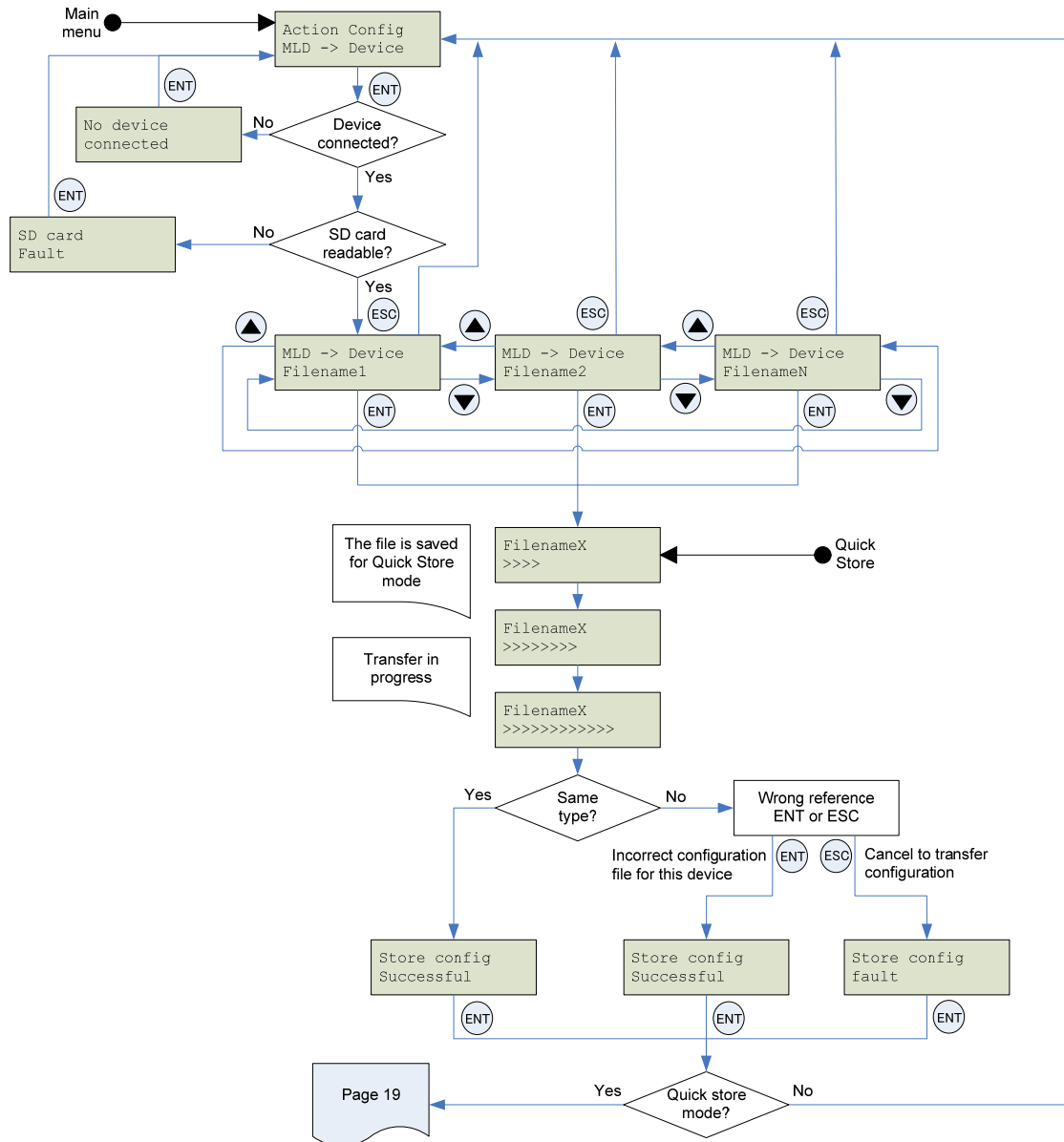

Note :

- Keep on pushing ESC key if the process of searching communication mode is canceled.
- Display is changed faster by keeping on pushing ▲ or ▼ key.

6.3. Action: Load configuration from inverter to Parameter writer

The diagram below shows the "Action Config / Device -> MLD" menu accessible from "Main menu / Action".
 "Action Config / Device -> MLD" : This menu accesses the transfer function for loading configurations from the inverter to the Parameter writer.

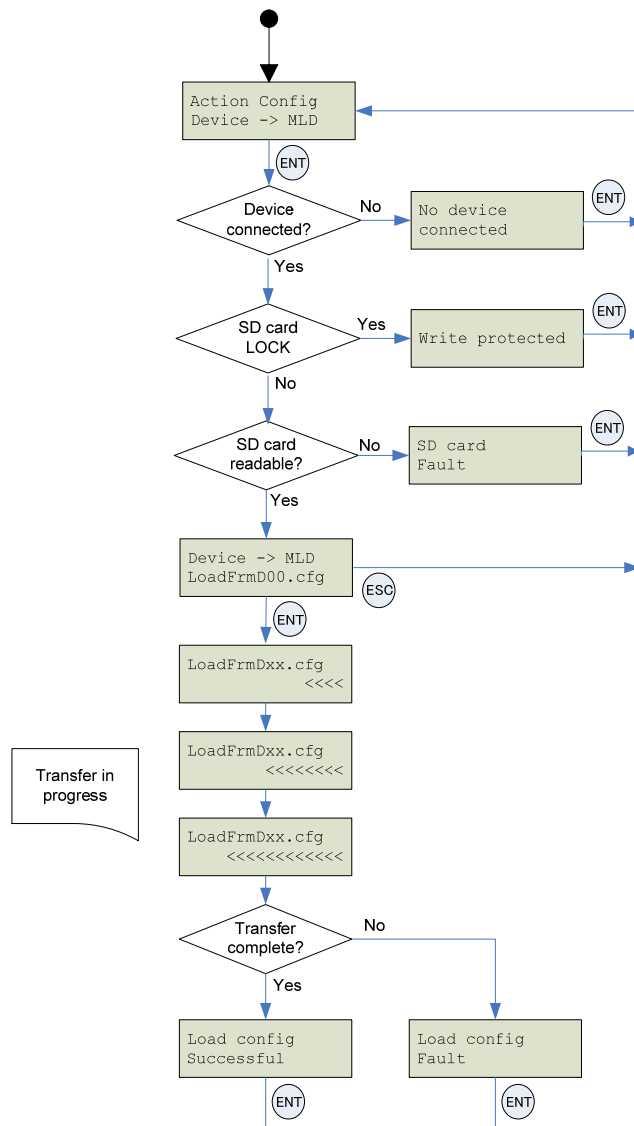

Note :

- Keep on pushing ESC key if the process of searching communication mode is canceled.
- Display is changed faster by keeping on pushing ▲ or ▼ key.

6.4. Quick Store mode

This mode is used to transfer the latest configuration file (See section 5.2). (1)

The diagram below shows the Quick Store mode, which can be accessed after using either of the "Action Config / MLD -> Device" menus.

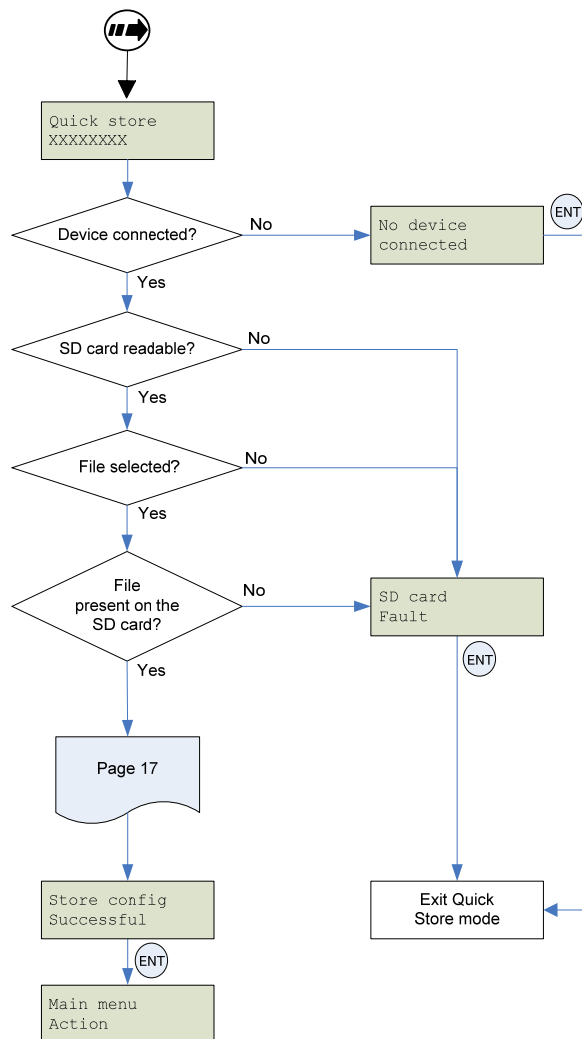

Note 1: Quick Store mode can only be used after an initial transfer to an inverter has been completed.

* Files can only be transferred between inverters with the same reference.

6.5. Supervision

The diagram below shows the device main menu, accessible from "Main menu / Device". This supervisory menu is used to check the reference and version of the inverter connected to the Parameter writer.

"Device Type" : This menu accesses the reference of the connected inverter.

"Device SW version" : This menu accesses the software version of the connected inverter.

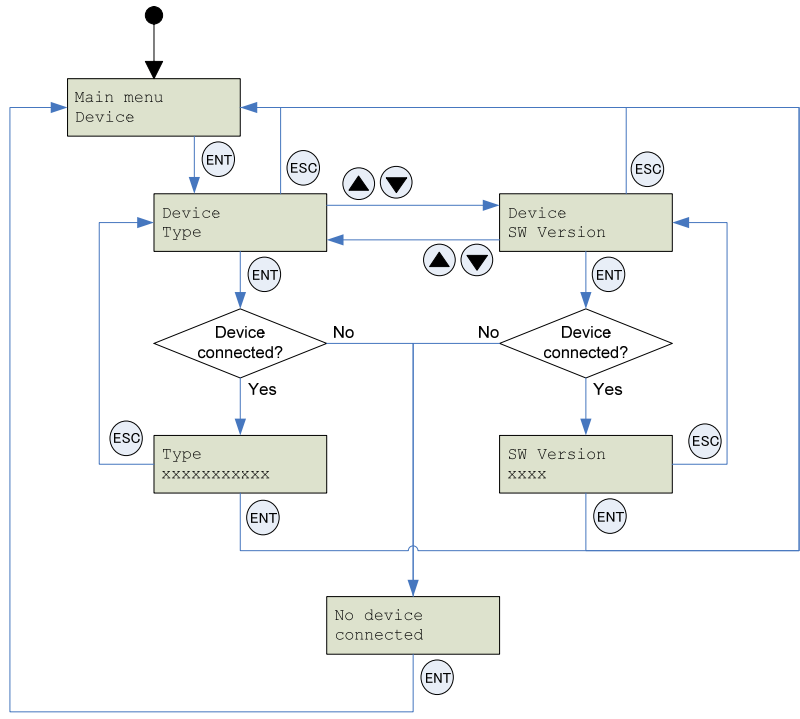

6.6. Parameter settings: Batteries

The diagram below shows the "Parameters / Battery" menu accessible from "Main menu / Parameters".

"Battery / Charge level" : This menu displays the Parameter writer charge level.

"Battery / Alarm level" : This menu is used to set message activation at a particular charge level. It warns the user about the battery charge status according to the set value (see message fault detected on section 6.7).

"Battery / Set battery type" : This menu is used to select the type of battery used by the Parameter writer (normal batteries or rechargeable batteries). Users must ensure that the correct battery type is selected so that the Parameter writer can accurately display the charge level. This also affects message activation.

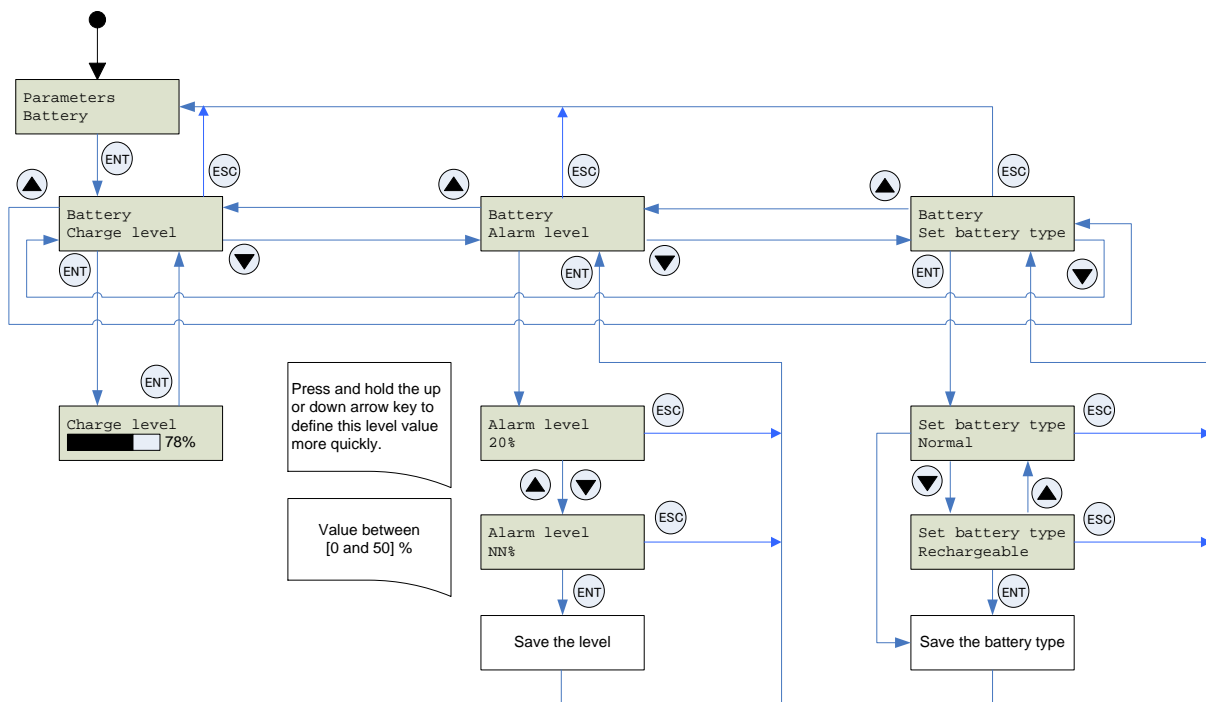

6.7. Parameter settings: Diagnostics

The diagram below shows the "Parameters / Diagnostic" menu accessible from "Main menu / Parameters".
 "Diagnostic / Fault History" : This menu accesses the detected fault history.
 "Diagnostic / Clear Faults" : This menu is used to clear the detected fault history

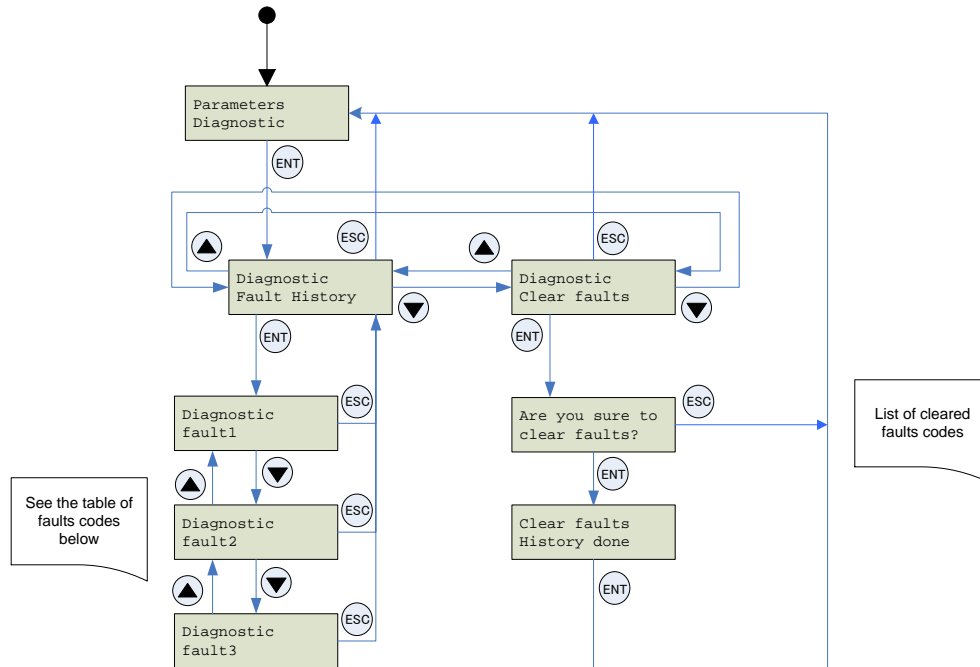

Parameter writer display	Probable cause	Remedy
Warning: Low Battery Level	The battery charge is low. The appearance of this message depends on the charge level defined by the user. (See setting the detection section 6.6)	- Make sure you have a set of replacement batteries to hand, as the current set have little life left.
Switch off Low battery	The battery charge is too low. The Parameter writer will turn off.	- Replace the batteries immediately. No more transfers can be made.
Store config fault	Incomplete or incorrect transfer to the inverter. The inverter is in parameter change prohibition state.	- Check the RJ45 cable and both of its connectors. Make sure the connection is secure for the duration of the transfer. Restart the transfer operation. - Confirm the inverter parameter setting.
Load config fault	Incomplete or incorrect transfer from the Parameter writer to the inverter. The inverter is in parameter read prohibition state.	
Wrong reference Fault	Bad transfer to the inverter; the configuration file selected is not compatible with the destination inverter.	- Check that the configuration file is compatible with the inverter to be configured.
No device connected	The inverter is not connected or is incorrectly connected.	- Check the RJ45 cable and both of its connectors. Make sure the connection is secure for the duration of the transfer. Connect the RJ45 cable.
No file selected	No configuration file is selected. There is no file present on the SD card.	- Select a file to transfer. - Follow the procedure for loading configuration files described on section 5.1.
SD card fault	The card is not recognized.	- Check that the SD card is inserted correctly. - Check that the SD card is formatted correctly.
SD card Write protected	The SD card is locked.	- Check if the SD card is locked.
Flash FW Fault	For factory use only	-

6.8. Parameter settings: Password

"Parameters / Password FW"

For factory use only.

6.9. Parameter settings: Display

The diagram below shows the "Parameters / Display" menu accessible from "Main menu / Parameters".

"Display / Contrast" : This menu is used to set the display screen contrast.

"Display / Backlight" : This menu is used to set the display screen time. (OFF, ON, 1 to 5 seconds are selected)

"Display / Sleep mode" : This menu is used to set the Parameter writer's sleep mode.

"Display / Language" : This menu accesses the language selection for the Parameter writer interface.

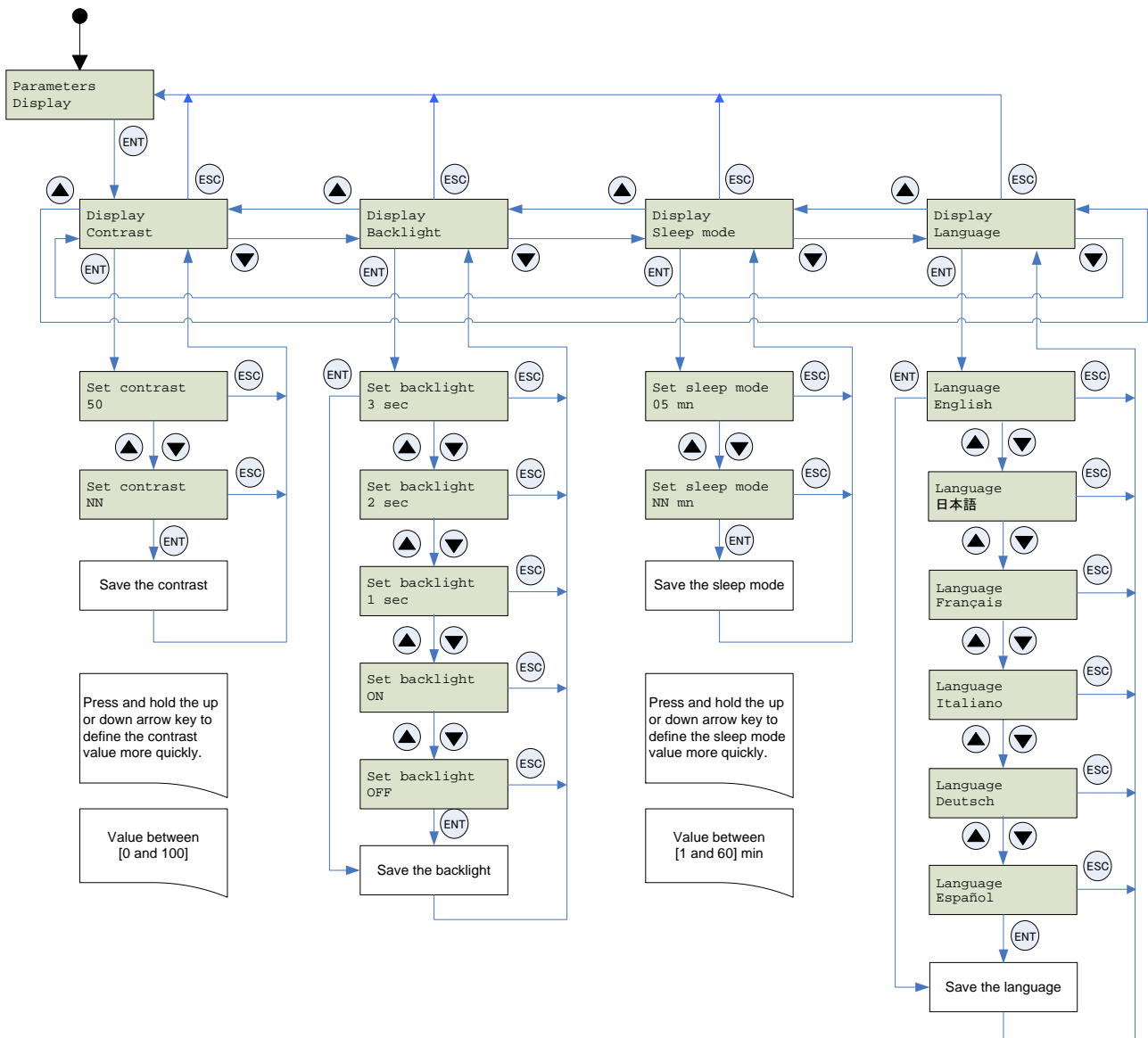

7. Specifications

Item	Specifications
Part number	PWU003Z
Applicable model	VF-nC3 or successor (Note)
Applicable OS	Windows XP, Windows Vista, or Windows 7
Communication setting	Communication setting automatic detection Communication baud rate : 4800, 9600, 19200, 38400 bps Parity : Non / Even / Odd parity Communication scheme: RS485
Applicable battery	4 x LR6 (AA) alkaline batteries or 4 x NiMH rechargeable batteries
Service environment	Indoor operation at an altitude of 1,000m or less and free from direct sunlight, potentially corrosive or explosive gases, steam, dust particles, dust/dirt, and machining fluids including grinding liquid and coolant
Protective method	IP20
Ambient temperature	-10 to +50°C
Storage temperature	-25 to +65°C
Relative humidity	20 to 93% (free from condensation and vapor)

Note) Update is needed this product's software for future inverters.

8. Warranty

Any part of the unit that is proved to be defective will be repaired free of charge under the following conditions:

1. This product will be repaired free of charge, if problem/fault occurs under normal handling within one year of delivery and is caused obviously by a design or manufacturing defect.
2. The warranty applies only to the delivered unit.
3. For the following kinds of failure or damage, the repair cost shall be borne by the customer even within the warranty period.
 - i) Failure or damage caused by improper or incorrect use or handling, or unauthorized repair or modification of the inverter.
 - ii) Failure or damage caused by the unit falling or an accident during transportation after the purchase.
 - iii) Failure or damage caused by fire, salty water or wind, corrosive gas, earthquake, storm or flood, lightning, abnormal voltage supply, or other natural disasters.
 - iv) Damage due to the use of Parameter writer for non-intended purposes.
4. If an additional warranty is provided then those conditions will also apply.